

UNITED STATES
DEPARTMENT OF THE INTERIOR
BUREAU OF LAND MANAGEMENT
Northwest Oregon District Office
1717 Fabry Road, S.E.
Salem, Oregon 97306

ORN01-TS-2021.0105
Carolyn's Cranes Timber Sale

Date: November 12, 2020

PROSPECTUS

THIS IS A PROSPECTUS ONLY. ATTACHMENTS MAY NOT INCLUDE ALL EXHIBITS REFERRED TO IN THE CONTRACT. THE COMPLETE CONTRACT, INCLUDING ALL EXHIBITS, IS AVAILABLE FOR INSPECTION AT THE NORTHWEST OREGON DISTRICT OFFICE.

NOTICE IS HEREBY GIVEN that the Bureau of Land Management will offer for sale timber as described herein for sealed bid, pursuant to Instructions to Bidders, as stated on Form No. 5440-9. **Sealed bids will be received by the District Manager, or his representative, by appointment only at the Northwest Oregon District Office, 1717 Fabry Road, S.E., Salem, Oregon until 4:00 p.m., Tuesday, December 15, 2020. Please call 503-375-5646 to make an appointment. Appointments are available from 8am - 4pm, M-F.** Sealed bids will be opened at 9:00 a.m. on Wednesday, December 16, 2020. Due to pandemic restrictions the opening will be limited to BLM employees. All bidders will be notified via phone call after all bids have been opened and a high bidder declared.

A WRITTEN BID on Form 5440-9 at not less than the appraised price on a unit basis per species and the required minimum bid deposit shall be required to participate in sealed bidding.

TO QUALIFY FOR PARTICIPATION in a sealed bid sale, the bidder must submit a bid in a sealed envelope for each tract offered that includes:

- 1. Two copies of the bid written on Form 5440-9, Deposit and Bid For Timber/Vegetative Resources. No bid for less than the advertised appraised price on a unit basis per species and total price can be considered.**
- 2. The required minimum bid deposit specified in the timber sale notice for the tract.**
- 3. A properly executed Independent Price Determination Certificate, Form 5430-11. A certification that the bid was arrived at by the bidder or offeror independently, and was tendered without collusion with any other bidder or offeror.**
- 4. A completed Form 5450-17, Export Determination.**
- 5. The sealed envelope must be clearly marked that it is a "Bid for Timber" together with the sale name and number, the legal description time and date of sale and a contact name and phone number of the bidder.**

THIS TIMBER SALE NOTICE does not constitute the decision document for purposes of protest and appeal of a forest management decision. Consistent with 43 CFR Subpart 5003-Administrative Remedies, the notice of a timber sale, when published as a legal ad in a newspaper of general circulation shall constitute the decision document for purposes of protest and appeal. The original Carolyn's Cranes notice of decision was released on August 19, 2020, followed by a 15-day protest period as required by 43 CFR subpart 5003.3. The doctrine of administrative finality precludes any further protest of the original Carolyn's Cranes Timber Sale. There have been no changes to the reoffered component of Carolyn's Cranes Timber Sale being offered for sale here. Consequently, there is no new protest opportunity, and this decision is effective immediately.

AN ENVIRONMENTAL ASSESSMENT was prepared for each timber sale tract, and a Finding of No Significant Impact has been documented. These documents are available for inspection as background for each timber sale tract at the Northwest Oregon District Office.

THE VOLUMES LISTED herein are estimates only. The sale volumes listed are based on 16-foot taper breaks which must be taken into consideration if comparisons are made with volume predictions based on other standards. The volumes based on 32-foot taper breaks are shown for comparison purposes. No sale shall be made for less than the advertised appraised price. The Purchaser shall be liable for the total purchase price, without regard to the amount bid per unit, even though the quantity of timber actually cut or removed or designated for taking is more or less than the estimated volume or quantity so listed.

THIS TIMBER SALE has been cruised based upon Eastside Scribner board foot measure. The minimum bid figures shown by species are dollars per thousand board feet (MBF). The minimum bid increment will be \$0.10 per MBF.

A PERFORMANCE BOND in an amount not less than 20 percent of the total purchase price will be required for all contracts of \$2,500 or more. A minimum performance bond of not less than \$500 will be required for all installment contracts less than \$2,500.

QUALIFIED SMALL BUSINESS concerns may apply to SBA for a loan to provide financing for access road construction required under the terms of qualifying timber sale contracts, and necessary contract changes will be made. Approval of loan applications rests with SBA and may be contingent on availability of funds. Applicants for such loans shall notify BLM of their intention to apply for a loan.

PRE-AWARD QUALIFICATIONS. The high bidder may be required to furnish information to determine the ability to perform the obligations of the contract. If the high bidder is determined not qualified, responsible or refuses to respond within fifteen (15) days of a request for information pertaining to qualifications, the contract may be offered and awarded for the amount of the high bid to the highest of the bidders who is qualified, responsible, and willing to accept the contract.

LOG EXPORT AND SUBSTITUTION: All timber sales, including timber from Federal rights-of-ways, shall be subject to the restrictions relating to the export and substitution of unprocessed timber from the United States in accordance with P.L. 94-165 and 43 CFR 5400 and 5420, as amended.

LOG EXPORT AND SUBSTITUTION RESTRICTIONS: Excepting Port-Orford-cedar, all timber offered for sale hereunder is restricted from export from the United States in the form of unprocessed timber and is prohibited from being used as a substitute for exported private timber. The BLM has revised the log export restrictions special provision to reduce the log branding and painting requirements. The new requirements include branding of one end of all logs with a scaling diameter of over 10 inches. All loads of 11 logs or more, regardless of the diameter of the logs, will have a minimum of 10 logs branded on one end. All logs will be branded on loads of 10 logs or less. One end of all branded logs will be marked with yellow paint. At the discretion of the Contracting Officer, the Purchaser may be required to brand and paint all logs. The Purchaser shall bear any increased costs for log branding and painting.

CONTRACT TERMINATION: A revised Special Provision has been added to the contract which enables the Contracting Officer to suspend the contract to facilitate protection of certain plant or animal species, and/or to modify or terminate the contract when necessary to: (1) Comply with the Endangered Species Act or to prevent incidental take of northern spotted owls in accordance with management direction in the Record of Decision (ROD) and Resource Management Plan (RMP), or; (2) Comply with a court order, or; (3) Protect species which were identified for protection through survey and manage and/or protection buffer standards and guidelines or management direction established in the ROD and RMP.

ADDITIONAL INFORMATION concerning this timber sale tract is available at the above District Office. A copy of the timber sale contract is also available for inspection at the District Office. The prospectus for this/these sale(s) is also available online at: <https://www.blm.gov/programs/natural-resources/forests-and-woodlands/timber-sales>. The prospectus includes maps and tables that cannot be made Section 508 compliant. For help with its data or information, please contact the Northwest Oregon District Office at 503-375-5646.

TIMBER SALE NOTICE

NORTHWEST OREGON DISTRICT
CASCADES FIELD OFFICE
SALEM DISTRICT MASTER UNIT

SALE DATE: December 16, 2020

CONTRACT NO. ORN01-TS-2021.0105, CAROLYN'S CRANES: LUMP SUM:
CLACKAMAS COUNTY, OREGON: O&C: SEALED BID: BID DEPOSIT REQUIRED: \$435,600.00.

All timber designated for cutting on: NW¹/₄, N ¹/₂SW¹/₄, SW¹/₄SE¹/₄, Sec. 15; N¹/₂SE¹/₄, Sec. 23, T. 7 S., R. 2 E., W.M.

THIS TIMBER SALE HAS BEEN CRUISED BASED UPON EASTSIDE SCRIBNER MEASURE.

Minimum bid figures shown by species are dollars per thousand board feet (MBF). The minimum bid increment will be \$0.10 per MBF.

Approx. No. Merchantable Trees	Est. Vol. Mbf 32' Log	Species	Est. Vol. Mbf 16' Log	Appraised Price Per Mbf	Estimated Volume Times Appraised Price
16,796	10,213	Douglas-fir	12,368	\$351.60	\$4,348,588.80
992	107	bigleaf maple	131	\$37.70	\$4,938.70
157	13	red alder	18	\$118.00	\$2,124.00
17,945	10,333	Totals	12,517		\$4,355,651.50

LOG EXPORT AND SUBSTITUTION RESTRICTIONS: All timber offered for sale hereunder is restricted from export from the United States in the form of unprocessed timber and also prohibited from substitution of exported private timber.

CRUISE INFORMATION: The timber volumes for the Regeneration Harvest Area and Right-of-Way was based on a variable plot cruise for estimating the board foot volume of trees. Plots were measured using a 40 basal factor. Approximately 0% of the total sale volume is salvage material. With respect to merchantable trees of all species; the average tree is 21.7 inches DBHOB; the average log contains 123 bd. ft.; the total gross volume is approximately 13,238 MBF; and 95% recovery is expected.

CUTTING AREA: 178 acres of Regeneration Harvest Area and 4 acres of Right-Of-Way. Acres shown on Exhibit A have been computed using a Trimble Geo XT Global Positioning System receiver. Acreage was calculated based on Global Positioning System traverse procedures including differential correction.

DURATION OF CONTRACT: Will be 36 months for cutting and removal of timber.

LOCATION: For access to the sale area please refer to the Timber Sale Vicinity Map and Exhibit D.

ACCESS AND ROAD MAINTENANCE:

Gate keys are required for access. Prospective bidders may obtain a 4C17 key from the Northwest Oregon District Office, please contact Jay Bernards at (503) 375-5671 to check out a key. A credit card is required at the time of checking out a key. A \$50.00 charge will apply if key is not returned.

Roads covered by Right-of-Way and Road Use Agreement S-440 between Port Blakely Tree Farms and the United States, the Purchaser shall enter into a license agreement with Port Blakely Tree Farms. The license agreement will be delivered to Port Blakely Tree Farms for execution at least 15 days prior to any use of company roads. See the Prospectus for full terms and conditions of use.

Roads covered by Right-of-Way and Road Use Agreement S-975 between Weyerhaeuser Company and the United States, the Purchaser shall enter into a license agreement with Weyerhaeuser Company. The license agreement will be delivered to Weyerhaeuser Company for execution at least 15 days prior to any use of company roads. See the Prospectus for full terms and conditions of use.

Roads covered by Access Road Easement S-1273 between Vern Weldon and the United States, the Purchaser shall comply with the terms and conditions of use. See the Prospectus for full terms and conditions of use.

ROAD MAINTENANCE: The Purchaser will be required to maintain all haul roads as shown on Exhibit D Road Use and Maintenance map(s). Purchaser maintenance shall include frequent blading and shaping of road surface, surface rock replacement, ditch, culvert, and catch basin cleaning, removal of minor slides, blow-down trees and other debris. Roads shall be left in a condition to withstand adverse weather at the end of each seasonal operation. Purchaser shall also be responsible for performing post storm inspections and maintenance during the winter season for all Purchaser maintained roads.

ROAD CONSTRUCTION: Estimates include the following: construct 1.69 miles of 16-foot subgrade and renovate 0.52 miles of 16-foot subgrade. Fourteen (14) culverts on new construction spur roads will be installed. All earth moving equipment to be washed prior to entry onto BLM lands. All natural surface roads may be rocked at the Purchasers expense.

SPECIAL ATTENTION ITEMS:

- Sec. 41.-Reserved timber
- Sec. 42.f-h -Seasonal restrictions
- Sec. 42.i -Safety
- Sec. 42.r -Snag Creation

Seasonal Restriction Matrix

Seasonal Restriction	Jan	Feb	Mar	Apr	May	Jun	Jul	Aug	Sep	Oct	Nov	Dec
Skidding operations (42.f.).												
No road construction, decommissioning, stabilizing or hauling on natural surface roads (42.g.).												
No in-stream work (42.h.).												
	Operations Restricted											
	No Restrictions											

**Seasonal restrictions may be shortened or extended as determined by Authorized Officer.

RESERVED

Sec. 41. Timber Reserved from Cutting

- a. All timber in the Reserve Area shown on Exhibit A and all orange painted trees which are on or mark the boundaries of the Reserve Area.
- b. All timber marked with orange paint above and below stump height in the Regeneration Harvest Area shown on Exhibit A.
- c. All timber inside the area posted as "Leave Island" as shown on Exhibit A.
- d. All existing snags and down logs which do not present a safety hazard as determined by the Authorized Officer. Snags felled for safety reasons shall be retained on site.

Sec. 42. Special Provisions

LOGGING

- a. Before beginning operations on the contract area for the first time or after a shutdown of seven (7) or more days, the Purchaser shall notify the Authorized Officer in writing of the date they plan to begin operations. The Purchaser shall also notify the Authorized Officer in writing if they intend to cease operations for any period of seven (7) or more days.
- b. Prior to the commencement of operations the Purchaser shall obtain from the Authorized Officer written approval of a written operations and logging plan commensurate with the terms and conditions of the contract, which shall include measures needed to ensure protection of the environment and watershed. A pre-work conference between the Purchasers authorized representative and the Authorized Officer must be held at a location designated by the Authorized Officer before the logging plan will be approved. All logging shall be done in accordance with the plan developed by this provision.
- c. At harvest unit landings, all logs, including hardwoods, more than eight (8) inches in diameter at the large end and exceeding eight (8) feet in length shall be decked or windrowed at the location designated by the Authorized Officer except logs sold and removed from the Contract Area.
- d. In all Harvest Areas – all yarding shall be done by equipment capable of transporting the leading end of logs clear of the ground and operated entirely on designated skid roads and/or skyline corridors. Before felling and yarding any timber, except road right-of-way timber, the Purchaser shall locate designated skid trails and/or skyline corridors as follows:
 1. Identify the location of designated skid roads and/or skyline corridors in a method approved by the Authorized Officer.
 2. Space designated skid roads and/or skyline corridors at a minimum of one-hundred and fifty (150) feet apart unless otherwise agreed to in writing by the Authorized Officer.
 3. Limit width of skid roads and/or skyline corridors to twelve (12) feet.

4. Ground-based operations are limited to slopes of thirty-five (35) percent or less. Ground-based operations may be approved on slopes up to fifty (50) percent when using specialized equipment, operating on previously constructed skid trails, or accessing isolated areas over steep pitches.

e. Excessive damage to the reserve timber, as determined by the Authorized Officer, will result in suspension of operation until mitigation measures are in place to prevent further damage as directed by the Authorized Officer.

f. No skidding between December 1st of one calendar year and March 31st of the following calendar year both days inclusive or during other periods of wet weather. This may be shortened or extended as determined by the Authorized Officer.

g. No road construction, road stabilizing, decommissioning, or hauling on natural surface roads shall be conducted between December 1st of one calendar year and April 30th of the following calendar year both days inclusive. This may be shortened or extended as determined by the Authorized Officer.

h. No in-stream work shall be conducted between September 1st of one calendar year and July 14th of the following calendar year both days inclusive to protect water quality.

SAFETY

i. Purchaser's operations shall facilitate BLM's safe and practical inspection of Purchaser's operations and BLM's conduct of other official duties on Contract Area. Purchaser has all responsibility for compliance with safety requirements for Purchaser's employees, contractors and subcontractors.

In the event that the Authorized Officer identifies a conflict between the requirements of this contract or agreed upon methods of proceeding hereunder and State or Federal safety requirements, the contract may be modified. If the cost of such contract modification is of a substantial nature (\$2,000.00 or more), the Purchaser may request, in writing, an adjustment in the total contract purchase price specified in Section 2 of the timber sale contract, as amended, to compensate for the changed conditions.

Unless otherwise specified in writing, when operations are in progress adjacent to or on roads and/or trails in the harvest unit area, Purchaser shall furnish, install, and maintain all temporary traffic controls that provide the road or trail user with adequate warning of and protection from hazardous or potentially hazardous conditions associated with its operations. Purchaser shall prepare a Traffic Control Plan, which the Purchaser has determined is compliant with state and local OSHA and Transportation standards no later than the pre-work meeting and prior to commencing operations. Traffic control devices shall be appropriate to current operating and/or weather conditions and shall be covered or removed when not needed. Flaggers and devices shall be as specified in state OSHA and Transportation standards for logging roads or the "Manual on Uniform Traffic Control Devices for Streets and Highways" (MUTCD) published by the U.S. Department of Transportation - Federal Highway Administration. Included in the Traffic Control Plan, Purchaser shall note traffic control device locations on a Purchaser produced copy of the contract Exhibit "A" Map.

ROAD CONSTRUCTION, RENOVATION, MAINTENANCE, AND USE

j. The Purchaser shall construct, renovate, and maintain roads in strict accordance with the plans and specifications shown on Exhibit C, which is attached hereto and made a part hereof. All natural surface roads may be rocked at the Purchasers expense with prior approval of the Authorized Officer. Any required construction, renovation, or maintenance of structures and roads shall be completed and accepted, in accordance with Section 18, prior to the removal of any timber, except right-of-way timber, over that road. The Purchaser shall not commence work until receipt of written notice to do so from the Authorized Officer.

k. The Purchaser shall perform any required road repair and maintenance work on roads identified as Purchaser maintenance, under the terms of Exhibit D, Road Maintenance Specifications, of this contract, which is attached hereto and made a part hereof. The Purchaser shall be permitted to remove ice or snow from roads authorized for use under this contract subject to the following terms and conditions:

- (1) Notification to BLM must be provided twenty-four (24) hours in advance of ice and snow removal operations.
- (2) Snowplowing shall be performed by utilizing a motor patrol grader or similar machine as approved by the Authorized Officer. Grader blades shall be equipped with shoes, runners, or other device to keep the grader blade a minimum of two inches (2") above the road surface. Any damage to the road or displacement of surfacing material will be the responsibility of the Purchaser to repair and/or replace at their expense.
- (3) Snow shall be plowed to the outside shoulder of the road and not into the ditchline. Snow berms created on the shoulder of the road must be swept off the road surface or day-lighted to allow surface water to drain off. Ditches and culverts shall be left functional upon completion of operations.
- (4) Existing turnouts along road must be cleared of snow to allow for safe vehicle passage.
- (5) No chemical and/or salt-based de-icer is allowed for use. Sand or ¾" minus or smaller crushed rock may be applied to the road surface for additional traction on iced sections. Traction rock shall be uniformly distributed and no greater than 1" depth. Purchaser shall clear road surface of traction rock as directed by the Authorized Officer. Any traction rock used will be at the Purchaser's expense.
- (6) Permission to remove snow/ice from Permittee maintained roads must be obtained from the Licensor prior to snow removal activities.

l. In the construction of P1/7-2E-15.1 (Seg. A) and P4/7-2E-14.0 (Seg. B) and the use of Road No. 7-2E-23 (Seg. A-B), 7-2E-23.4 (Seg. A-C, E), 7-2E-15, and, 7-2E-14 the Purchaser shall comply with the conditions of Right-of-Way and Road Use Agreement No. S-440 (Serial No. OR046308) dated March 17, 1960, between the United States of America and Port Blakely Tree Farms (Limited Partnership). This document is available for inspection at the Northwest Oregon District Office in Salem.

These conditions include:

- (1) Payment of a road use obligation of thirty-seven five-hundred fifty-one and 00/100 dollars (\$37,551.00) for 12,517 MBF to Port Blakely Tree Farms Limited Partnership, payable at the time indicated in the License Agreement.
- (2) Purchaser shall maintain the roads in accordance with the specifications in the timber sale contract.
- (3) Purchaser shall place rock on roads in lieu of payment of rockwear fee.
- (4) Purchaser shall carry liability insurance coverages \$500,000/\$500,000/\$500,000 and performance bond of \$3,000.00.
- (5) Prior to the use of said road, the Purchaser shall furnish the Authorized Officer a properly signed copy of the executed License Agreement.
- (6) Default by the Purchaser of said Right-of-Way and Road Use Agreement, or any License Agreement executed pursuant thereto, for failure to pay appropriate road use fees shall be considered a violation of this contract. The amount of unpaid fees shall be considered as the amount of damage suffered by the Government as a result of the violation of this provision.

m. In the construction of 7-2E-15.1 (Seg. B), the Purchaser shall comply with the conditions of Right-of-Way and Road Use Agreement No. S-975 (Serial No. OR045540) dated November 2, 1987, between the United States of America and Weyerhaeuser Company. This document is available for inspection at the Northwest Oregon District Office in Salem.

These conditions include:

- (1) Prior to cutting or removing any timber from the road right-of-way between Stations 2+16 and 15+90 on Road No. 7-2E-15.01 (Segment B), the Purchaser shall pay to Weyerhaeuser, the owner of the right-of-way timber, the total purchase price of ten-thousand three-hundred seventy-seven and 78/100 dollars (\$10,377.78) for that timber.
- (2) Purchaser shall carry liability insurance coverages \$1,000,000/\$1,000,000/\$1,000,000 and performance bond of \$1,000.00.
- (3) Prior to the construction of said road, the Purchaser shall furnish the Authorized Officer a properly signed copy of the executed License Agreement.
- (4) Default by the Purchaser of said Right-of-Way and Road Use Agreement, or any License Agreement executed pursuant thereto, for failure to pay appropriate road use fees shall be considered a violation of this contract. The amount of unpaid fees shall be considered as the amount of damage suffered by the Government as a result of the violation of this provision.

n. In the use of Road No. 7-2E-23.4 (Seg. D), the Purchaser shall comply with the conditions of Access Road Easement RE-S-1273 (Serial No. OR069737), dated June 15, 2020, between the United States of America and Vern Weldon. This document is available for inspection at the Northwest Oregon District Office in Salem.

o. The Purchaser agrees that if they elect to use any other private road, which is the subject of a right-of-way agreement with the Government for the removal of Government timber sold under the terms of this contract, Purchaser shall request and agree to the modification of this contract to provide for such use and for allowances for amortization of the Government's share of the capital investment of any such road.

ENVIRONMENTAL PROTECTION

p. In order to prevent the spread of noxious weeds, the Purchaser shall pressure wash all earth disturbing equipment and logging equipment prior to entry onto BLM lands as directed by the Authorized Officer. Cleaning shall be defined as removal of all dirt, grease, plant parts and material that may carry noxious weed seeds. Equipment shall be inspected by the Authorized Officer at a site approved by the Authorized Officer to verify that the equipment had been reasonably cleaned prior to entry onto BLM lands.

q. In additions to the requirements set forth in Sec. 26 of this contract, he Purchaser shall cover skid trails with logging slash and debris, install water bars or comparable erosion control measures, and block entrances or other created access points on the contract areas shown on Exhibit A as directed by the Authorized Officer. This work shall be completed within fifteen (15) days after completion of log hauling from each landing.

r. The Purchaser shall saw top sixty-one (61), top girdle sixty-one (61), and base girdle sixty (60) green, reserve conifer trees as selected and directed by the Authorized Officer in Harvest Areas shown on Exhibit A. Tree topping and base girdling shall be completed in accordance with Exhibit I of this contract. All topping and girdling operations shall be completed to the satisfaction of the Authorized Officer within one year after yarding is completed and within thirty (30) days after being notified by the Authorized Officer to commence topping and girdling operations.

s. The Purchaser shall immediately discontinue specified construction or timber harvesting operations upon written notice from the Contracting Officer that:

- (1) threatened or endangered plants or animals protected under the Endangered Species Act of 1973, as amended, may be affected by the operation, and a determination is made that consultation or reinitiating of consultation is required concerning the species prior to continuing operation, or;
- (2) when, in order to comply with the Endangered Species Act, or to prevent incidental take of northern spotted owls in accordance with management direction in the Record of Decision (ROD) and Resource Management Plan (RMP), the Contracting Officer determines it may be necessary to modify or terminate the contract, or;

- (3) federal proposed, federal candidate, Bureau sensitive or State listed species protected under BLM Manual 6840 - Special Status Species Management - have been identified, and a determination is made that continued operations would affect the species or its habitat, or;
- (4) when, in order to comply with a court order, which enjoins operations on the sale or otherwise requires the Bureau of Land Management to suspend operations, or;
- (5) when, in order to comply with a court order, the Contracting Officer determines it may be necessary to modify or terminate the contract, or;
- (6) species have been discovered which were identified for protection in accordance with management direction established in the ROD and RMP, and the Contracting Officer determines that continued operations would affect the species or its habitat, or;
- (7) When, in order to protect species which were identified for protection in accordance with management direction established in the ROD and RMP, the Contracting Officer determines it may be necessary to modify or terminate the contract.

Those operations necessary for a safe removal of personnel and equipment from the contract area and those directed by the Contracting Officer, which are required in order to leave the contract area in an acceptable condition will be permitted. Discontinued operations may be resumed upon receipt of written instructions and authorization by the Contracting Officer.

During any period of suspension, the Purchaser may withdraw performance and payment bond coverage aside from that deemed necessary by the Authorized Officer to secure cut and/or removed timber for which the Bureau of Land Management has not received payment, and/or unfulfilled contract requirements associated with harvest operations that have already occurred and associated post-harvest requirements.

In the event of a suspension period or a combination of suspension periods that exceed a total of 30 days, the First Installment held on deposit may be temporarily reduced upon the written request of the Purchaser. For the period of suspension extending beyond 30 days, the First Installment on deposit may be reduced to five (5) percent of the First Installment amount listed in Section 3.b. of the contract. Any First Installment amount temporarily reduced may be refunded or transferred to another BLM contract at the request of the Purchaser. However, if the Purchaser has outstanding debt owing the United States, the Contracting Officer must first apply the amount of First Installment that could be refunded to the debt owed in accordance with the Debt Collection Improvement Act, as amended (31 USC 3710, et seq.). Upon Purchaser's receipt of a bill for collection and written notice from the Contracting Officer lifting the suspension, the Purchaser shall restore the First Installment to the full amount shown in Section 3.b. of the contract within 15 days after the bill for collection is issued, subject to Section 3.j. of the contract. The Purchaser shall not resume contract operations until the First Installment amount is fully restored.

In the event of a suspension period or a combination of suspension periods that exceed a total of 30 days, the unamortized Out-of-Pocket Expenses for road or other construction required pursuant to Exhibit C of the contract shall be refunded or transferred to another BLM contract at the request of the Purchaser. Upon written notice from the Contracting Officer lifting the suspension, the Purchaser shall reimburse the Government the amounts refunded or transferred. The Purchaser may choose to pay this reimbursement at once or in installments payable at the same time as payments are due for the timber under the contract and in amounts approximately equal to the expenses associated with the timber for which payment is due.

In the event that operating time is lost as a result of the incorporation of additional contract requirements, or delays due to Endangered Species Act consultation with the U.S. Fish and Wildlife Service or U.S. National Marine Fisheries Service, or court-ordered injunctions, the Purchaser agrees that an extension of time, without reappraisal, will constitute a full and complete remedy for any claim that delays due to the suspension hindered performance of the contract or resulted in damages of any kind to the Purchaser.

The Contracting Officer may determine that it is necessary to modify the contract or terminate the cutting and removal rights under the contract in order to comply with the Endangered Species Act, prevent incidental take of northern spotted owls in accordance with the ROD and RMP, protect species that have been discovered which were identified for protection in accordance with management direction established in the ROD and RMP, or comply with a court order. Following the issuance of a written notice that cutting and removal rights will be terminated, the Purchaser will be permitted to remove timber cut under the contract, if allowed by the Endangered Species Act, if able to proceed without causing incidental take of northern spotted owls in accordance with the ROD and RMP, consistent with species protection in accordance with management direction established in the ROD and RMP, or court order requirements necessitating the modification or termination.

In the event the contract is modified or cutting and removal rights are terminated under this subsection, the Purchaser agrees that the liability of the United States shall be limited to the actual costs incurred by the Purchaser which have not been amortized by timber removed from the contract area. This calculation of liability shall utilize actual Purchaser costs and Government estimates of timber volumes. At the Authorized Officer's request, the Purchaser agrees to provide documentation of the actual costs incurred in the performance of the contract. In addition, the Purchaser shall be released from the obligation to pay the contract price for any timber which is not authorized to be removed from the contract area.

The Purchaser specifically and expressly waives any right to claim damages, other than those described in the preceding paragraphs, based on an alleged breach of any duty to the Purchaser, whether express or implied, in regard to the manner in which the Government defended the litigation which resulted in the court order affecting the operation of the contract. This waiver also extends to any claims based on effects on the operation of the contract that arise from litigation against another agency. Furthermore, the Purchaser specifically acknowledges and agrees that a court ruling that the Government violated the Administrative Procedures Act cannot be interpreted, in itself, to mean that the Government had not acted reasonably in regard to its duties to the Purchaser under this contract.

FIRE PREVENTION

t. Primarily for purposes of fire prevention and control, the Purchaser shall, prior to the operation of power driven equipment in construction or logging operations under this contract during the fire season or periods of fire danger, prepare a fire prevention and control plan to the satisfaction of the Authorized Officer. Purchaser shall take such measures for prevention and suppression of fire on the contract area and other adjacent Government lands used or traversed by Purchaser in connection with operations as are required by applicable laws and regulations. However, when in the opinion of the Authorized Officer, weather and other conditions affecting fire incidence and control make special precautions necessary to protect the contract area and said Government lands, Purchaser shall take such additional or other fire prevention and control measures as may be required by the Authorized Officer. The Purchaser shall comply with Oregon Department of Forestry Industrial Fire Precaution Level (IFPL) I Fire Season requirements. At IFPL II and III, additional fire prevention and control provisions may be added as determined by the Authorized Officer and specified in written instructions to the Purchaser to mitigate dry

fuel and weather conditions.

LOGGING RESIDUE REDUCTION

u. In addition to the requirements of Sec. 15 of this contract, and notwithstanding the Purchasers satisfactory compliance with State laws and regulations regarding offsetting or abating the additional fire hazard created by this operation and the States willingness to release the Purchaser from liability for such hazard, the Purchaser shall remain responsible to the Government for performance of the following hazard reduction measure(s) required by this contract: Perform logging residue reduction and site preparation work on approximately fifty-three (53) acres of harvest area located within harvest units. The required work shall consist of any treatment or combination of treatments, as determined by the Authorized Officer and specified in writing by the Contracting Officer. The number of acres of each treatment shall be determined by the Authorized Officer. Prior to commencement of any operation under this Section of the contract, a slash disposal and pre-work conference between the purchaser's representative and the Authorized Officer must be held at a location designated by the Authorized Officer. The number of acres of each treatment shall be determined by the Authorized Officer. All slash disposal shall be done in accordance with the plans developed at this pre-work conference. Slash, as defined for this section, shall mean all material (brush, limbs, tops, unmerchantable stems, and chunks) severed or knocked over as a result of purchaser's operations under the terms of this contract.

1. Excavator pile and burn slash within ground-based portion of Regeneration Harvest Areas from skid trails. Slash shall be piled by an excavator equipped with a hydraulic thumb. Finished piles shall be tight and free of dirt.

a. Unmerchantable logs greater than six (6) inches on the small end shall be left in place, or positioned so that they will not be burned.

b. Machine piles shall be located as far as possible from reserve green trees, snags, or unit boundaries to minimize damage.

c. Machine piling equipment would travel on previously used skid trails during dry soil conditions. In areas inaccessible from designated skid trails where the slope is less than 35 percent, machine piling equipment would be allowed one pass over a slash mat.

d. Machine piles shall be kept free of dirt and other non-wood debris and constructed as compactly as possible. There should be an adequate supply of finer fuels located within and under the covered area of the pile to ensure ignition of the larger fuels.

e. A minimum 10-foot by 10-foot cover of four (4) mil. polyethylene shall cap each machine pile to maintain a dry ignition point. The cover shall be firmly fixed to each pile to hold it in place. Plastic shall be held in place with woody debris or tied with rope or twine. The plastic must be secured so that it is held in place during strong wind conditions. The Purchaser is required to furnish the covering materials. Covering shall be completed as directed by the Authorized Officer.

f. Cutting Areas shall be piled during the same season that they are logged.

2. Pile and burn landing slash within thirty (30) feet of the edge of each landing, all tops, broken pieces, limbs and debris more than one (1) inch in diameter at the large end and longer than three (3) feet in length shall be piled within fifteen (15) days of completion of hauling logs from that landing. Landing piles shall be kept free of dirt and located adjacent to roads at least twenty (20) feet from any Reserve Tree and/or as directed by the Authorized Officer. Upon completion of landing piling, the Purchaser shall prepare the landing piles for burning by securely covering each landing pile by securely covering each pile with four (4) mil. thick polyethylene plastic film at least 20 feet wide. Landing piles shall be 75 percent covered with the covering extending three-quarters of the way down all sides. The plastic shall be oriented southwest to northeast. Pieces of burnable material shall be placed on top of the plastic to secure it from moving and to prevent it from blowing off during strong wind episodes. The Purchaser is required to furnish the covering materials. The timing of this covering work shall be in accordance with instructions from the Authorized Officer. No landing debris shall be dozed off the landing and covered with dirt. Debris which has been buried and is determined to be the source of holdover fire shall be excavated by the Purchaser, at the Purchaser's expense, with a tractor and/or hydraulic excavator as directed by the Authorized Officer. If the structure of the landing piles will not permit adequate consumption of piled debris by burning, the Purchaser shall re-pile them at the direction of the Authorized Officer.

v. Notwithstanding the provisions of Sec. 15 of this contract, the Government shall assume all obligations for disposal or reduction of fire hazards created by Purchaser's operations on Government lands, except for burning and mop-up assistance as required herein and measures required in Section 42.u. The Purchaser shall, under supervision of the Authorized Officer or designated representative, assist in preparing units for burning, burning, mop-up, and patrol by furnishing, at the Purchaser's own expense, the services of personnel and equipment on each unit as shown below:

1. For Igniting, Burning, Mop-up of Piles on Units:

a. One work leader(s) Firefighter Type 1 (FFT1) qualified according to National Wildfire Coordinating Group (NWCG) Wildland Fire Qualifications System guide, PMS 310-1) to supervise crew and equipment operations, and to serve as Purchaser's representative.

b. Five-person crew Firefighter Type 2 (FFT2) qualified according to National Wildfire Coordination Group (NWCG) Wildland Fire Qualifications System guide, PMS 310-1, with sufficient fuel for burning, six (6) drip torches, one (1) power saw, and one (1) backpack pump, one (1) tool for each crew member.

c. The crew shall arrive on the project area with radios capable of inter-crew communications and communication with a BLM representative at a ratio of one (1) radio per every five (5) crew members.

d. All ignition and mop-up personnel will be directly supervised by a BLM representative.

Aircraft and pilots used for Logging Residue Reduction or the suppression of escaped fires from Logging Residue Reduction operations, shall be acquired from a list of aircraft and pilots approved (i.e., carded for these specific activities) by the Office of Aircraft Services or the U.S. Forest Service. This list is available from BLM District Offices upon request.

All listed personnel shall be physically fit, experienced, and fully capable of functioning as required. In addition, all listed personnel shall be qualified according to the National Wildfire Coordinating Group (NWCG) Wildland Fire Qualification System Guide, PMS-310-1 and provide documentation of these qualifications. On the day of ignition all listed personnel shall be fluent in speaking and understanding English, clothing shall consist of long pants and long sleeved shirts, and be of approved aramid fabric (Nomex™ or equivalent), as well as being free of diesel fuel oil. All personnel shall wear lug sole boots with minimum eight (8) inch tall uppers that provide ankle support, approved hardhats and leather gloves. Personnel who do not meet these requirements or do not have proper clothing and personal protective equipment (PPE) will not be allowed to participate. All listed tools and equipment shall be in good usable condition. All power-driven equipment shall be fully fueled and available for immediate use. During periods of use under this subsection, the Purchaser shall provide fuel and maintenance for all such power-driven equipment.

Except as provided hereafter for fire escapement, the Purchaser shall continue the required assistance in mop up on each cutting unit shown on Exhibit A for seventy-two (72) hours, as directed by the Authorized Officer within a five (5) day period commencing at 8:00 a.m. the day following the completion of ignition in that unit, or until released from such service by the Government, whichever occurs first.

In event of a fire escapement, the Purchaser's personnel and equipment shall, under supervision of the Authorized Officer, take action to control and mop up the escaped fire until released from such service by the Government. If it becomes necessary to use furnished personnel and equipment for the suppression of a fire which escapes from the prescribed fire area for a period beyond the remainder of the day in which the fire escapes, then the Government shall, at its option: (1) reimburse the Purchaser for such additional use of personnel and equipment at wage rates shown in the current Administratively Determined Pay Rates for the Western Area and at equipment rates shown in the current Oregon-Washington Interagency Fire Fighting Equipment Rental Rates schedule until the Purchaser is released from such service by the Government; or (2) release the Purchaser from additional suppression work and assume responsibility for suppressing the escaped fire.

In situations where an escaped fire is controlled and contained by an adequate fire break (i.e., trail, road, stream, rock formation, etc.), the Government may permit the Purchaser to remove personnel for that day; provided that all mop up work on the escaped fire is included with mop up work on the prescribed fire area. In such an event, the Purchaser must sign a statement of agreement to complete mop up work on all escaped fire areas concurrently with mop up work on the prescribed fire area.

In case of injury to personnel or damage to equipment furnished as required by this subsection, liability shall be borne by the Purchaser, unless such injury or damage is caused by Government negligence.

Time is of the essence in complying with this provision. In the event the Purchaser fails to provide the

personnel and equipment required herein, the Purchaser shall be responsible for all additional cost incurred by the Government in disposing of slash including but not limited to the wages and other costs of providing federal employees and others as substitute labor force, the cost of providing substitute equipment and appropriate additional overhead expenses. If the Purchaser's failure results in a deferral of burning and new conditions necessitate additional personnel and equipment to accomplish the planned burn, the Purchaser also shall be responsible for such additional costs.

LOG EXPORT RESTRICTIONS

w. All timber sold to the Purchaser under the terms of the contract, except exempted species, is restricted from export under the United States in the form of unprocessed timber, and is prohibited from being used as a substitute for exported private timber. For the purpose of this contract, unprocessed timber is defined as: (1) any logs, except those of utility grade or below, such as sawlogs, peeler logs, and pulp logs; (2) cants or squares to be subsequently remanufactured exceeding eight and three-quarters (8-3/4) inches in thickness; (3) split or round bolts or other roundwood not processed to standards or specifications or suitable for end-product uses; or (4) western red cedar lumber which does not meet lumber of American Standards Grades of Number 3 dimension or better, or Pacific Lumber Inspection Bureau R-List Grades of Number 3 Common or better. Thus, timber manufactured into the following will be considered processed: (1) lumber and construction timbers regardless of size, manufactured to standards and specifications suitable for end-product uses; (2) chips, pulp, and pulp products; (3) green or dry veneer and plywood; (4) poles and piling cut or treated for use as such; (5) cants, squares, and lumber cut for remanufacturing of eight and three-quarters (8-3/4) inches in thickness or less; (6) shakes and shingles.

Substitution will be determined under the definition found in 43 CFR 5400.0-5(n).

The Purchaser is required to maintain and upon request to furnish the following information:

1. Date of last export sale.
2. Volume of timber contained in last export sale.
3. Volume of timber exported in the past twelve (12) months from the date of last export sale.
4. Volume of Federal timber purchased in the past twelve (12) months from the date of last export sale.
5. Volume of timber exported in succeeding twelve (12) months from date of last export sale.
6. Volume of Federal timber purchased in succeeding twelve (12) months from date of last export sale.

In the event the Purchaser elects to sell any or all of the timber sold under this contract in the form of unprocessed timber, the Purchaser shall require each party buying, exchanging, or receiving such timber to execute a "Certificate as to Nonsubstitution and the Domestic Processing of Timber". The original of such certification shall be filed with the Authorized Officer. Additionally, when the other party is an affiliate of the Purchaser, the Purchaser will be required to update information under item (2) of Form 5450-17 (Export Determination) and file the form with the Authorized Officer.

In the event an affiliate of the Purchaser has exported private timber within twelve (12) months prior to purchaser or otherwise acquiring Federal timber sold under this contract, the Purchaser shall, upon request, obtain from the affiliate information in the form specified by the Authorized Officer and furnish the information to the Authorized Officer.

Prior to the termination of this contract, the Purchaser shall submit to the Authorized Officer Form 5460-15 (Log Scale and Disposition of Timber Removed Report) which shall be executed by the Purchaser. In

addition, the Purchaser is required under the terms of this contract, to retain for a three-year period from the date of termination of the contract the records of all sales or transfer of logs involving timber from the sale for inspection and use of the Bureau of Land Management.

Unless otherwise authorized in writing by the Contracting Officer, the Purchaser shall brand clearly and legibly one end of all logs with a scaling diameter (small end inside bark) of over 10 inches, prior to the removal of timber from the contract area. All loads of 11 logs or more will have a minimum of 10 logs clearly and legibly branded on one end regardless of the diameter of the logs. All logs will be branded on loads of 10 logs or less. One end of all branded logs to be processed domestically will be marked with a 3 square inch spot of highway yellow paint. The Purchaser will stop trucks for accountability monitoring at mutually agreed upon locations when notified by the Authorized Officer.

If multiple trailers (mule trains) are used, each bunked load shall be considered an individual load, and these guidelines will apply to each bunked load. If a flatbed stake trailer is used, each bundle will be treated as a separate load.

At the discretion of the Contracting Officer, the Purchaser may be required to brand and paint all logs. Any increased cost for log branding and painting shall be the responsibility of the Purchaser.

In the event of the Purchaser's noncompliance with this subsection of the contract, the Authorized Officer may take appropriate action as set forth in Section 10 of this contract. In addition, the Purchaser may be declared ineligible to receive future awards of Government timber for a period of one year.



UNITED STATES DEPARTMENT OF THE INTERIOR
Bureau of Land Management
Northwest Oregon District

Carolyn's Cranes
Timber Sale
EXHIBIT A
Page 1 of 2

TIMBER SALE CONTRACT MAP - ORN01-TS-2021.0105
T. 7 S. - R. 2 E., Section 15, W.M.

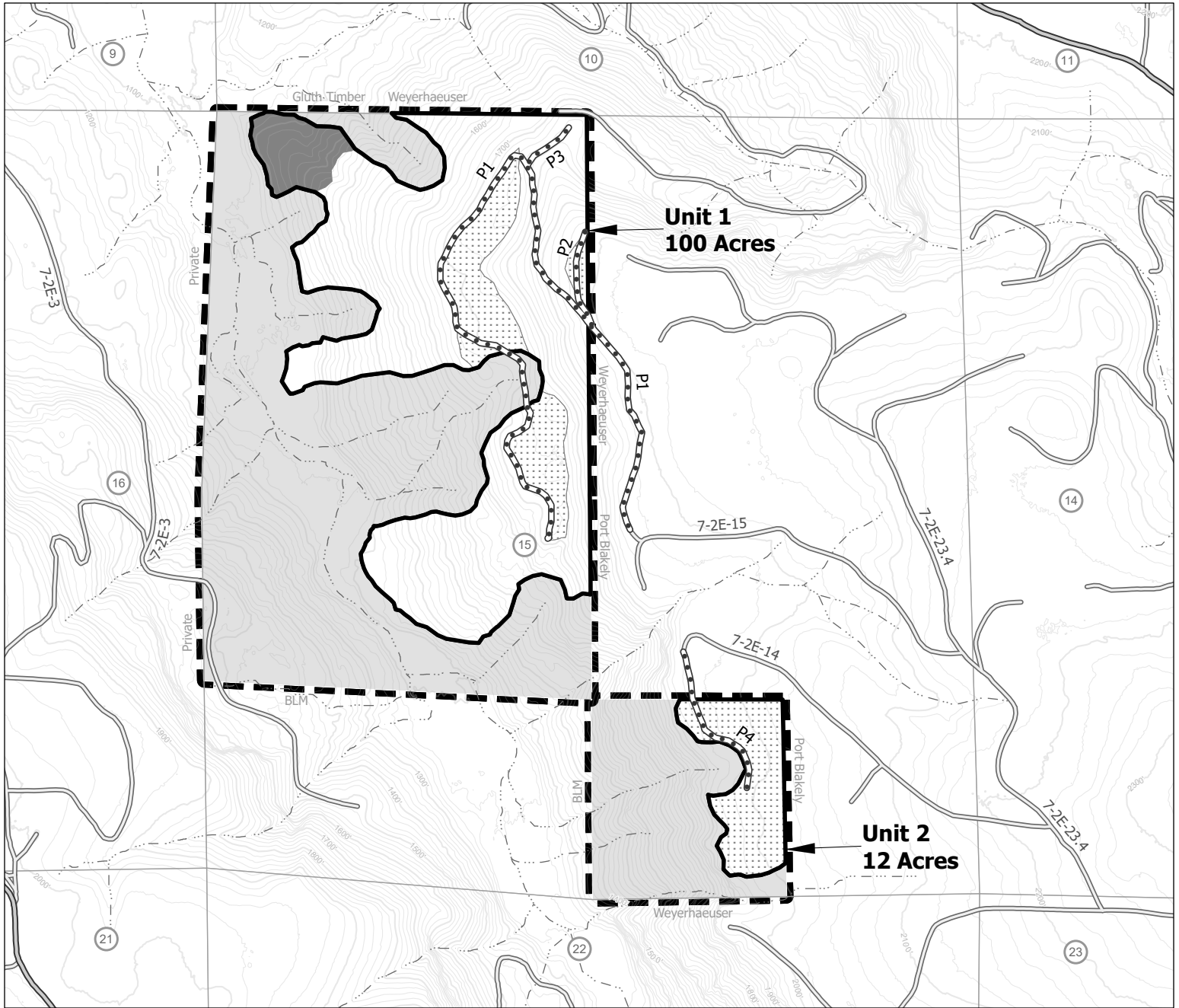

Contour Interval: 20'

- Road to be Constructed
- County Road
- Existing Road
- Stream
- Leave Island
- Unit Boundary
- Regeneration Harvest Area
- Contract Area
- Reserve Area

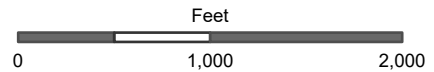

Regeneration Harvest Area	178.00 Acres
Leave Island	10.00 Acres
Road Right-of-Way	4.00 Acres
Reserve Area	164.26 Acres
Total Contract Area	356.26 Acres

Unit boundaries are painted orange and posted. Acres do not include existing or new roads. Acreage was calculated based on global positioning system traverse procedures including differential correction.



TIMBER SALE CONTRACT MAP - ORN01-TS-2021.0105
T. 7 S. - R. 2 E., Section 23, W.M.

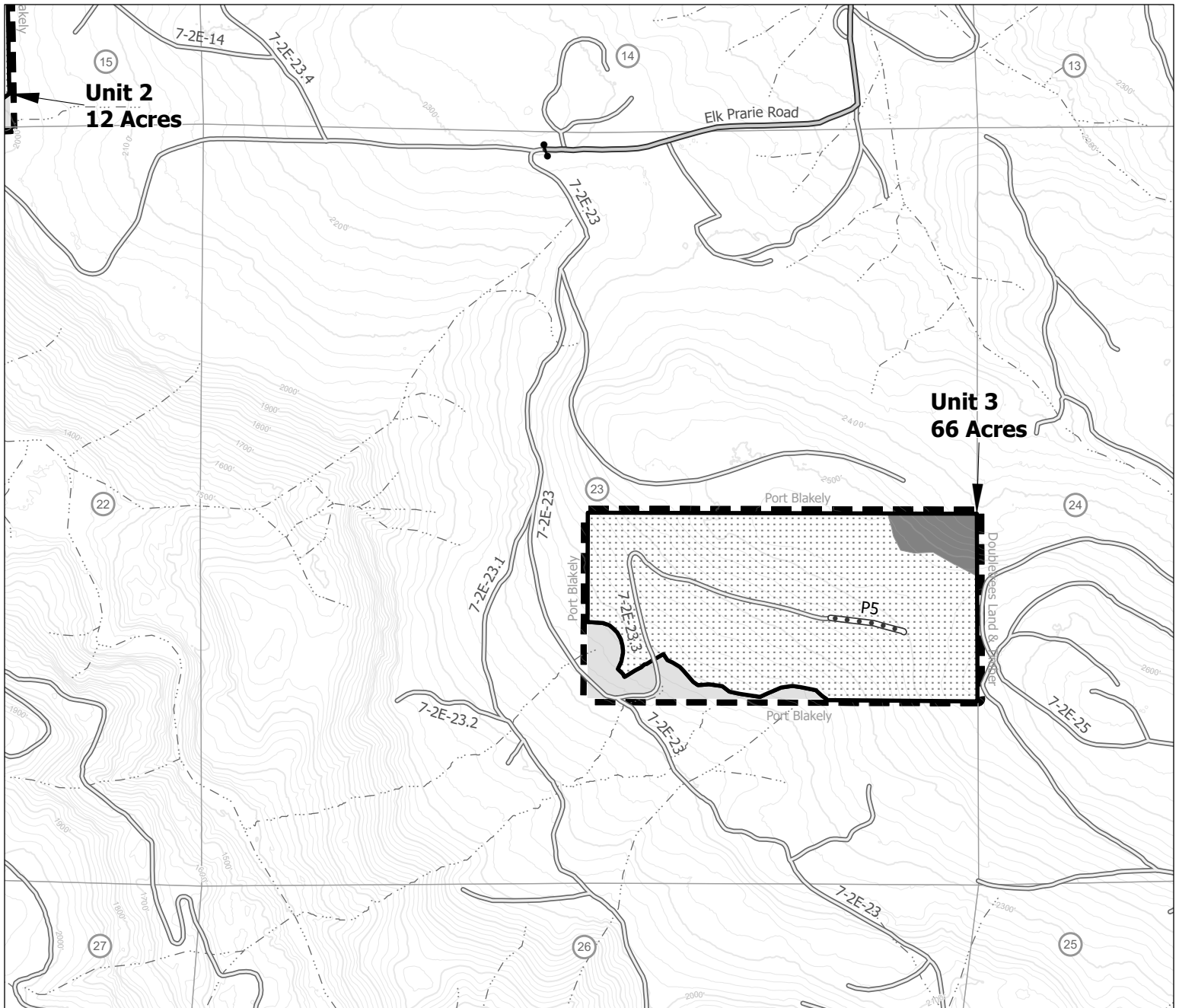

Contour Interval: 20'

- Gate
- Road to be Constructed
- County Road
- Existing Road
- Stream
- Leave Island
- Unit Boundary
- Regeneration Harvest Area
- Contract Area
- Reserve Area

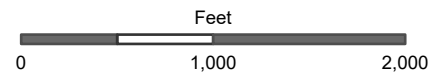

Regeneration Harvest Area	178.00 Acres
Leave Island	10.00 Acres
Road Right-of-Way	4.00 Acres
Reserve Area	164.26 Acres
Total Contract Area	356.26 Acres

Unit boundaries are painted orange and posted. Acres do not include existing or new roads. Acreage was calculated based on global positioning system traverse procedures including differential correction.

UNITED STATES
DEPARTMENT OF THE INTERIOR
BUREAU OF LAND MANAGEMENT

Contract No.
ORN01-TS-2021.0105
Carolyn's Cranes

EXHIBIT B / PRE-SALE

5450-3

The following estimates and calculations of value of timber sold are made solely as an administrative aid for determining: (1) adjustments made or credits given in accordance with Secs. 6, 9, or 11; (2) when payments are due; and (3) value of timber subject to any special bonding provisions. The value of timber will be determined by multiplying the value per acre as shown below, times the amount of acreage as determined by the Authorized Officer, which has been cut or removed or designated for taking. Except as provided in Sec. 2, Purchaser shall be liable for total purchase price even though quantity of timber actually cut or removed or designated for taking is less than the estimated volume or quantity shown. Cutting areas are shown on **Exhibit A**.

SPECIES	ESTIMATED VOLUME OR QUANTITY <i>(Units Specified)</i>		PRICE PER UNIT	ESTIMATED VOLUME OR QUANTITY X UNIT PRICE
Douglas Fir	12,368.0	MBF	\$351.60	\$4,348,588.80
Bigleaf Maple	131.0	MBF	\$37.70	\$4,938.70
Red Alder	18.0	MBF	\$118.00	\$2,124.00
TOTALS	12,517.0	MBF		\$4,355,651.50

The apportionment of the total purchase price is as follows:

Unit 1

Douglas Fir	7,112.0 MBF	X	\$351.60	=	\$2,500,579.20
Bigleaf Maple	112.0 MBF	X	\$37.70	=	\$4,222.40
Red Alder	8.0 MBF	X	\$118.00	=	\$944.00
Total	7232.0 Mbf				\$2,505,745.60 ÷ 100.0 acres = \$25,057.46/Acre

Unit 2

Douglas Fir	853.0 MBF	X	\$351.60	=	\$299,914.80
Bigleaf Maple	14.0 MBF	X	\$37.70	=	\$527.80
Red Alder	1.0 MBF	X	\$118.00	=	\$118.00
Total	868.0 Mbf				\$300,560.60 ÷ 12.0 acres = \$25,046.72/Acre

Unit 3

Douglas Fir	4,119.0 MBF	X	\$351.60	=	\$1,448,240.40
Red Alder	8.0 MBF	X	\$118.00	=	\$944.00
Total	4127.0 Mbf				\$1,449,184.40 ÷ 66.0 acres = \$21,957.34/Acre

Unit R/W

Douglas Fir	284.0 MBF	X	\$351.60	=	\$99,854.40
Bigleaf Maple	5.0 MBF	X	\$37.70	=	\$188.50
Red Alder	1.0 MBF	X	\$118.00	=	\$118.00
Total	290.0 Mbf				\$100,160.90 ÷ 4.0 acres = \$25,040.23/Acre

U.S. DEPT. OF THE INTERIOR
Bureau of Land Management
NORTHWEST OREGON DISTRICT
TIMBER SALE CONTRACT
Road Specifications

TABLE OF CONTENTS

Section	Description
	Road Plan Maps
	Road Plan and Detail Sheet
100	General
200	Clearing and Grubbing
300	Excavation and Embankment
400	Pipe Culverts
500	Renovation and Improvement of Existing Roads
600	Watering
1000	Aggregate Base Course - Crushed Rock
1200	Aggregate Surface Course - Crushed Rock
1700	Erosion Control
1800	Soil Stabilization
2100	Roadside Brushing



UNITED STATES DEPARTMENT OF THE INTERIOR
 Bureau of Land Management
 Cascades Field Office - Northwest Oregon District
Carolyn's Cranes - Exhibit C
Timber Sale Road Plan Map - Page 1 of 1
 T. 7 S. - R. 2 E., Section 15, 23, W.M.

- Gates
- Existing Culvert
- Culvert to Install
- Landing
- Road to be Constructed
- County Road
- Existing Road
- Route Approved for Haul
- Stream
- Carolyn's Cranes Harvest Area
- Bureau of Land Management
- Private or Other Owner

No warranty is made by the Bureau of Land Management as to the accuracy, reliability or completeness of these data for individual use or aggregate use with other data. Original data was compiled from multiple source data and may not meet U.S. National Mapping Accuracy Standard of the Office of Management and Budget.

N
 0 1,000 2,000
 Feet

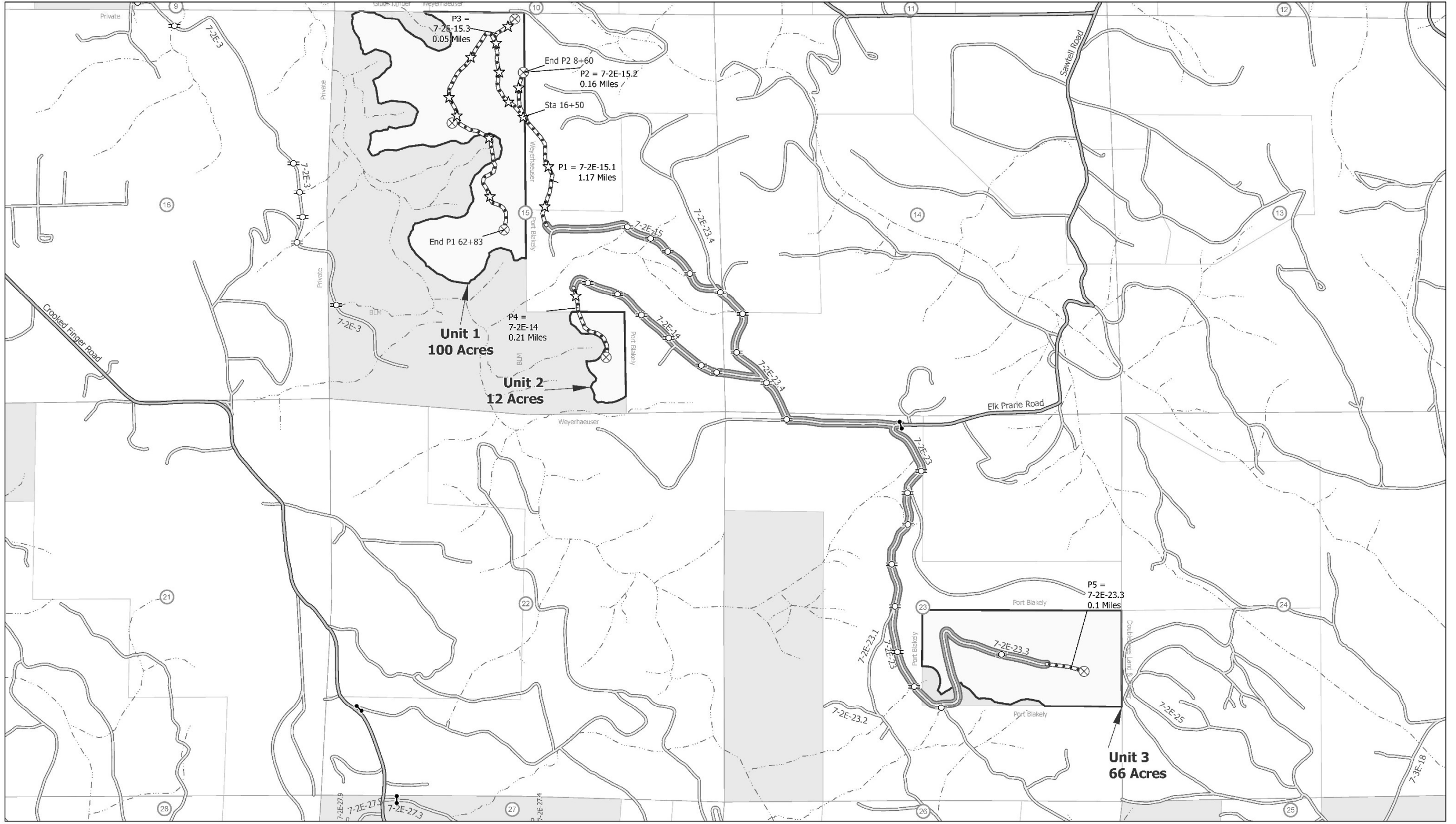

ROAD PLAN AND DETAIL SHEET

Road Number	Pre-Haul Maint. Length (miles)	Road Renovate Length (miles)	New Construct Length (miles)	Typical Section Type	Subgrade Width (*1 & 4)	Culverts to Install (See Sec. 400)	Surfacing (*5)					Remarks					
							Base Course: 1000			Surface Course: 1200							
							Min. Width	Comp. Depth	Surface Type (*3)	Grading Size (*3)	Estimated Cubic Yards		Min. Width	Comp. Depth	Surface Type (*3)	Grading Size (*3)	Estimated Cubic Yards
7-2E-23.4	0.76			6	16	0									Brush, Blade, Roll, and clean culverts		
7-2E-15	0.52			6	16	0					12'	4"	ASC	C (1.5"-0)	273	Brush, Blade, Roll, and clean culverts. Surface rock last 0.25mi	
P1/7-2E-15.1			1.17	5,6	16	11	13'	8"	ABC	A (3"-0)	757	12'	4"	ASC	C (1.5"-0)	326	See Sheets 4-7
P2/7-2E-15.2			0.16	6	16	1	13'	8"	ABC	A (3"-0)	410	12'	4"	ASC	C (1.5"-0)	177	See Sheets 4 and 5
P3/7-2E-15.3			0.05	5	16	1										See Sheet 4	
7-2E-14	0.58			6	16	0										Brush, Blade, Roll, and clean culverts	
P4/7-2E-14			0.21	5	16	1										Brush, Blade, Roll, and clean culverts	
7-2E-23	0.81			6	16	0										Brush, Blade, Roll, and clean culverts	
7-2E-23.3		0.52		5	16	1										Brush, Blade, Roll, and clean culverts. Fill/compact slump 0+80	
P5/7-2E-23.3			0.10	5	16	0										Extension of existing road.	
TOTAL	2.67	0.52	1.69			15					1167				776	Quantities sh	

Note: All new road construction roads will have a minimum curve radius of 60 feet and a maximum grade of 18%. All landing subgrades will utilize the posted Right-of-Way area while maintaining the cut and fill slopes in the Typical Section Types below.

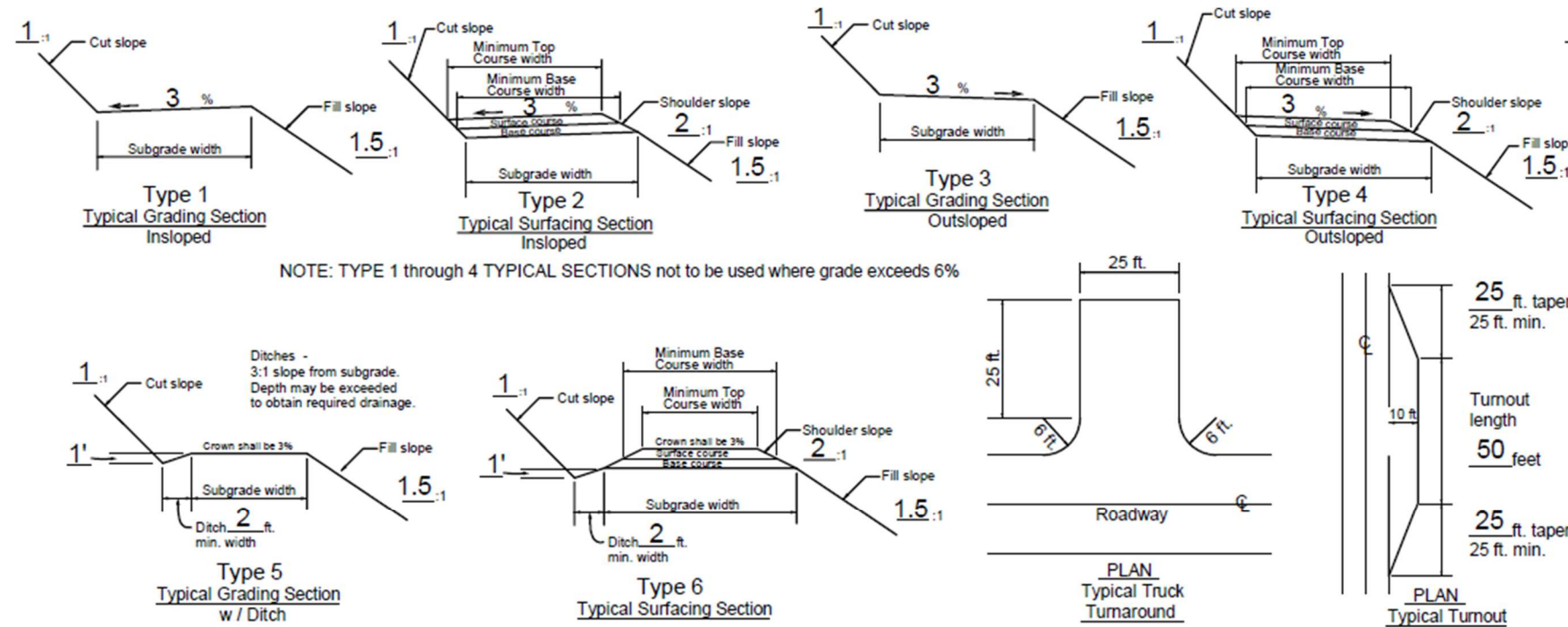

NOTE: TYPE 1 through 4 TYPICAL SECTIONS not to be used where grade exceeds 6%

*NOTES

- Extra subgrade widths**
 Add to each shoulder: 1 foot for fills of 1 to 6 feet. Widen inside or outside shoulder of tight curves as needed for log trucks to maneuver, with tires remaining on roadbed.
- Backslopes**

Materials	Cut slopes	Fill slopes
Solid rock	1/2:1	Angle of repose
Soft rock and shale	3/4:1	1:1
Common	Slopes under 55% 1:1	1-1/2:1
	Slopes over 55% 1-1/2:1	1-1/2:1

Note:
 Full bench construction is required on side slopes exceeding 60%.
 Slope Ratio = Horizontal Distance:Vertical Distance (HD:VD)
- Surface type**

	Grading
PRR - Pit run rock	C - 1 1/2" minus
GRR - Grid rolled rock	D - 1" minus (surface course)
SRN - Screened rock	E - 3/4" minus (surface course)
JRR - Jaw run rock	
ABC - Aggr. base course	A - 3" minus (base course)
ASC - Aggr. surface course	B - 2" minus (base course)
WC - Wood chips	C - 3" (base course)
- Turnouts**
 Width shall be 10 feet in addition to the subgrade width, with lengths as shown on this plan, or as directed by the Authorized Officer.
- Surfacing**
 Turnouts, curve widening, and the first 50 feet of all road aprons shall be surfaced, for all road stations requiring surfacing, as listed above, and as directed by the Authorized Officer.
- Clearing width** 200
 See Section _____
- As posted and painted for Right-of-Way, and as required in Section 2100 of this contract.
- Grading (Renovation)** 500
 See Section _____
- Drainage** 400
 See Section _____
 Culvert site aggregate, as designated in Section 400 of this contract, does not fulfill any requirements as listed above for full lifts of surface or base applications.
- Compaction** 300 and 500
 See Sections _____ and _____

SPUR P1

0+00	BEGIN NEW CONSTRUCTION ON PORT BLAKLEY PROPERTY
2+16	PROPERTY LINE - ENTER WEYERHAEUSER
4+00	INSTALL 24"X 30' CULVERT, USE NATIVE MATERIAL FOR BEDDING ALL CULVERTS IN NEW CONSTRUCTION
8+20	INSTALL 24"X 30' CULVERT
12+20	BUILD A COMBINATION TRUCK TURN OUT AND TURN AROUND
13+60	-12% GRADE AHEAD
14+50	-15% GRADE AHEAD. BEGIN FULLBENCH/ENDHAUL CONSTRUCTION. MATERIAL MUST BE END HAULED OR DRIFTED TO THE SWITCHBACK CORNER AT STATION 28+00. CLEAN MATERIAL WILL BE USED TO BUILD A THROUGH FILL. ANY EXCESS MATERIAL, AS WELL AS STUMPS AND LARGE BRUSH, SHALL BE PILED IN A DESIGNATED WASTE ARE ON THE INSIDE OF THE SWITCHBACK CURVE.
15+10	BEGIN JUNCTION WITH SPUR P2 TO THE RIGHT, SEE DETAILS ON PAGE 5 OF 24.
15+60	APPROXIMATE LOCATION OF 18"X 40' CULVERT WITH A 10' DOWNSPOUT
16+50	END OF P2 JUNCTION. SEE PAGES 6-7 OF 24 FOR CROSS SECTIONS OF THE FULL BENCH PORTION OF THE ROAD FROM STATION 16+50 TO 31+00
19+00	INSTALL 18"X 30' CULVERT WITH A 10' DOWNSPOUT
22+00	INSTALL 18"X 30' CULVERT WITH A 10' DOWNSPOUT
25+00	INSTALL 18"X 30' CULVERT WITH A 10' DOWNSPOUT
27+50	BEGIN CONSTRUCTION OF 100' RADIUS CURVE. LAY CUT SLOPE BACK TO 1:1 AND ADD CURVE WIDENING. THE GRADE AROUND THE CURVE SHALL BE 12% OR LESS.
28+00	END OF FULL BENCH - BEGIN BUILDING A THROUGH FILL. FILL WILL BE CONSTRUCTED IN 1 FOOT LIFTS USING A SHEEPS-FOOT ROLLER (OR OTHER SPECIALTY COMPACTION ROLLER APPROVED BY THE BLM) WITH CLEAN EXCAVATED MATERIAL FROM THE FULL BENCH SECTION. MATERIAL MUST HAVE AN APPROPRIATE MOISTURE CONTENT, OR WATER MAY NEED TO BE ADDED.
28+20	SPUR P3 TO THE RIGHT - CONSTRUCT A TRUCK TURN AROUND IN THE INTERSECTION. THE DITCH LINE BELOW STATION 25+00 WILL BE ROUTED TO FLOW DOWN INTO THE DITCH OF SPUR P3.
30+00	END OF CURVE - CONSTRUCT A WASTE AREA ON THE INSIDE OF THE SWITCHBACK FOR EXCESS SOIL AND STUMPS. ORGANIC MATERIAL MUST BE PILED SEPARATELY SO THAT IT MAY BE BURNED UPON COMPLETION OF THE LOGGING
31+50	END OF THROUGH FILL, RESUME STANDARD ROAD CONSTRUCTION FOR THE REMAINDER OF THE SPUR
34+00	INSTALL 18"X 30' CULVERT
35+00	CONSTRCT A 70'X70' LANDING ON THE RIGHT SIDE ON THE ROAD
38+80	CONSTRCT A 70'X70' LANDING ON THE RIGHT SIDE ON THE ROAD
39+00	INSTALL 18"X 30' CULVERT
43+00	CONSTRUCT A 100' STUB SPUR TO THE RIGHT TO A 70' X 70' LANDING. INSTALL 24"X 40' CULVERT ACROSS THE JUNCTION
46+25	INSTALL 24"X 30' CULVERT
47+00 TO 51+00	ROAD CROSSES RIPARIAN RESERVE AREA, DO NOT DISTURB GROUND OUTSIDE OF THE TAGGED CLEARING LIMITS
55+00	INSTALL 18"X 30' CULVERT
55+50	CONSTRCT A 70'X70' LANDING ON THE RIGHT SIDE ON THE ROAD
61+00	CONSTRCT A 70'X70' LANDING - END OF SPUR P1

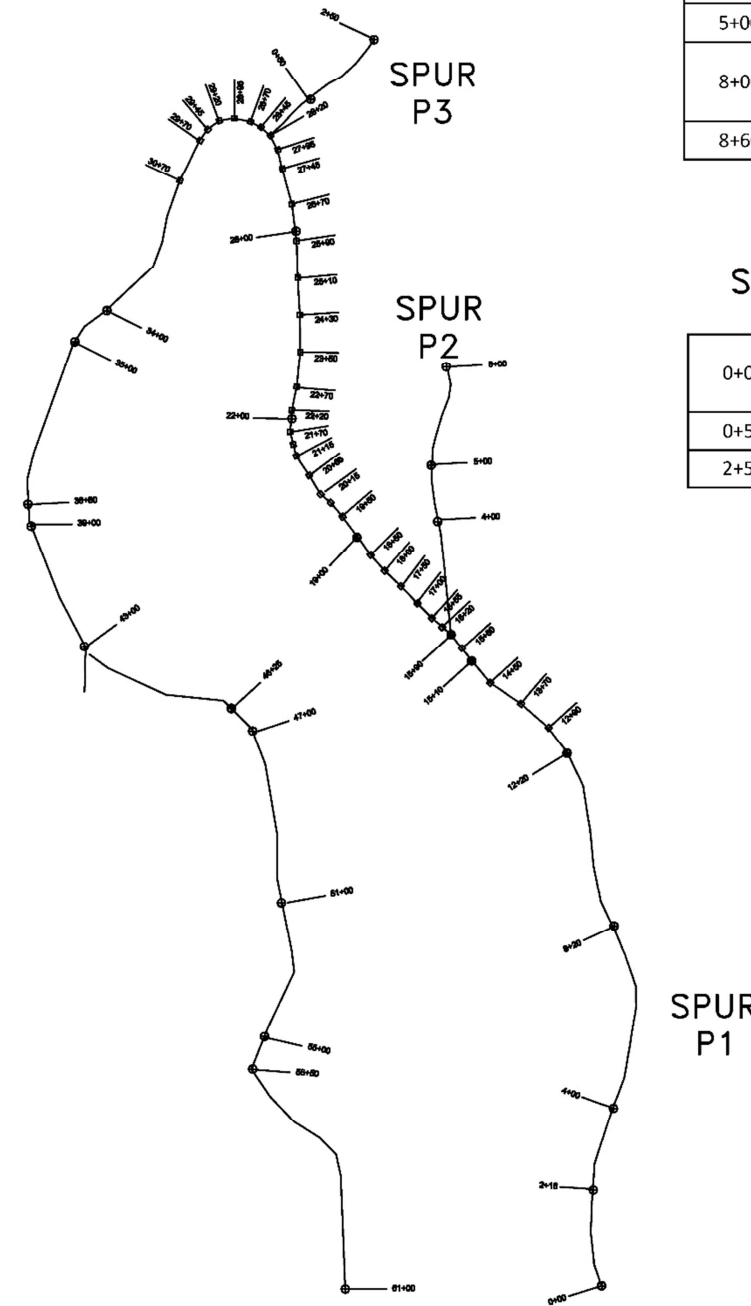

SPUR P2

0+00	BUILD A JUNCTION WITH SPUR P1 AT STATION 15+10
4+00	CONSTRUCT A LANDING 40' x 100' +5% GRADE AHEAD
5+00	INSTALL 18"X 30' CULVERT WITH A 10' DOWNSPOUT
8+00	CONSTRUCT A LANDING 70' X 70'. WEYERHAEUSER/BLM PROPERTY LINE WILL RUN THROUGH THE LANDING AND THE BACK PORTION OF THE LANDING WILL BE ON WEYERHAEUSER
8+60	END OF SPUR P2

SPUR P3

0+00	BUILD A JUNCTION WITH SPUR P1 AT STATION 28+20. DITCHLINE FROM SPUR P1 SHALL FLOW INTO THE CULVERT AT STATION 0+50 ON SPUR P3
0+50	INSTALL 18"X 30' CULVERT WITH A 10' DOWNSPOUT.
2+50	CONSTRUCT A 70'X70' LANDING - END OF SPUR P3

REV. NO.	DESCRIPTION	DATE	APPROVED
UNITED STATES DEPARTMENT OF THE INTERIOR BUREAU OF LAND MANAGEMENT NW OREGON DISTRICT CASCADDES FIELD OFFICE			
CAROLYN'S CRANES SPURS P1, P2, P3 CONSTRUCTION NOTES			
DRAWN: C LESNIAK		NOT TO SCALE	
DATE: 6/26/2020		SHEET OF	

15+10 - JUNCTION OF SPUR P-1 AND P-2.

THE JUNCTION OF P2 WILL BE TEMPORARY. WHEN ACCESS TO SPUR P2 IS NEEDED, DRIFT MATERIAL FROM SPUR 2 DOWN OVER THE TOP OF SPUR P1 TO CREATE A SMOOTH VERTICAL CURVE. INSTALL A SKEWED CULVERT 18" X 40' WITH A 10' DOWNSPOUT. WHEN FINISHED WITH SPUR P2, PULL THE MATERIAL BACK UP ONTO THE BED OF P2. THE CLEAN FILL MATERIAL MUST BE POSITIONED NEAR THE EDGE SO THAT IT MAY BE USED AGAIN WITH MINIMAL WORK.

UPON COMPLETION OF THE UNIT, SPUR P1 MUST HAVE A SMOOTH CONTINUOUS GRADE OF -15% THROUGH THE JUNCTION. P2 WILL HAVE A NARROW, STEEP TAKEOFF THAT IS ACCESSIBLE TO A PICK-UP. THE CULVERT SHALL REMAIN IN PLACE, AND THE ROAD SHALL BE INSLOPED BETWEEN STATION 14+50 AND 15+90. PAST STATION 15+90, THE ROAD SHALL BE A TYPICAL 16' SUBGRADE, WITH A 12' ROCKED RUNNING SURFACE, AND A 3 FOOT DITCH.

CONFIGURATION WITH SPUR P-1 IN USE

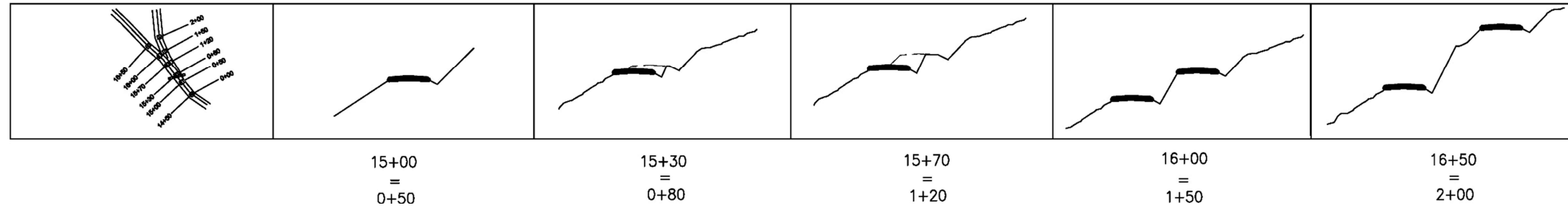

CONFIGURATION WITH SPUR P-2 IN USE

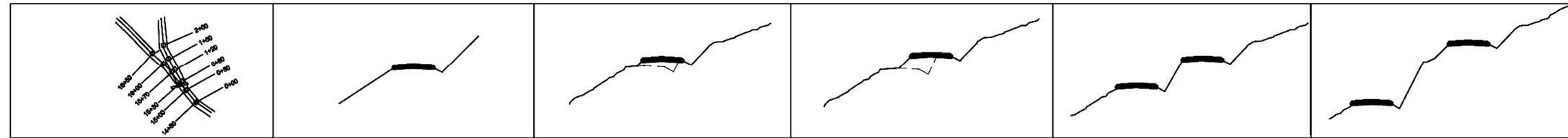

CONFIGURATION UPON COMPLETION OF THE UNIT

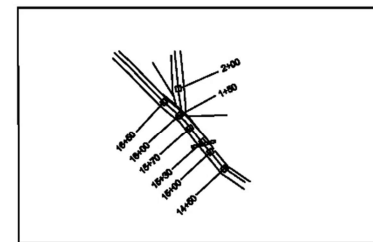

REV. NO.	DESCRIPTION	DATE	APPROVED
UNITED STATES DEPARTMENT OF THE INTERIOR BUREAU OF LAND MANAGEMENT NW OREGON DISTRICT CASCADES FIELD OFFICE			
CAROLYN'S CRANES JUNCTION OF P1 AND P2 CONSTRUCTION NOTES			
DRAWN: C LESNIAK		NOT TO SCALE	
DATE: 6/26/2020		SHEET OF	

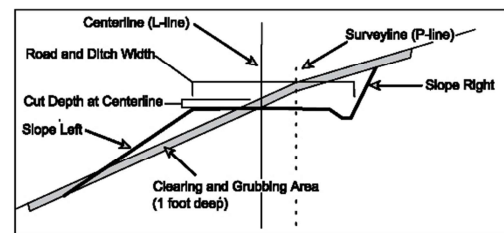
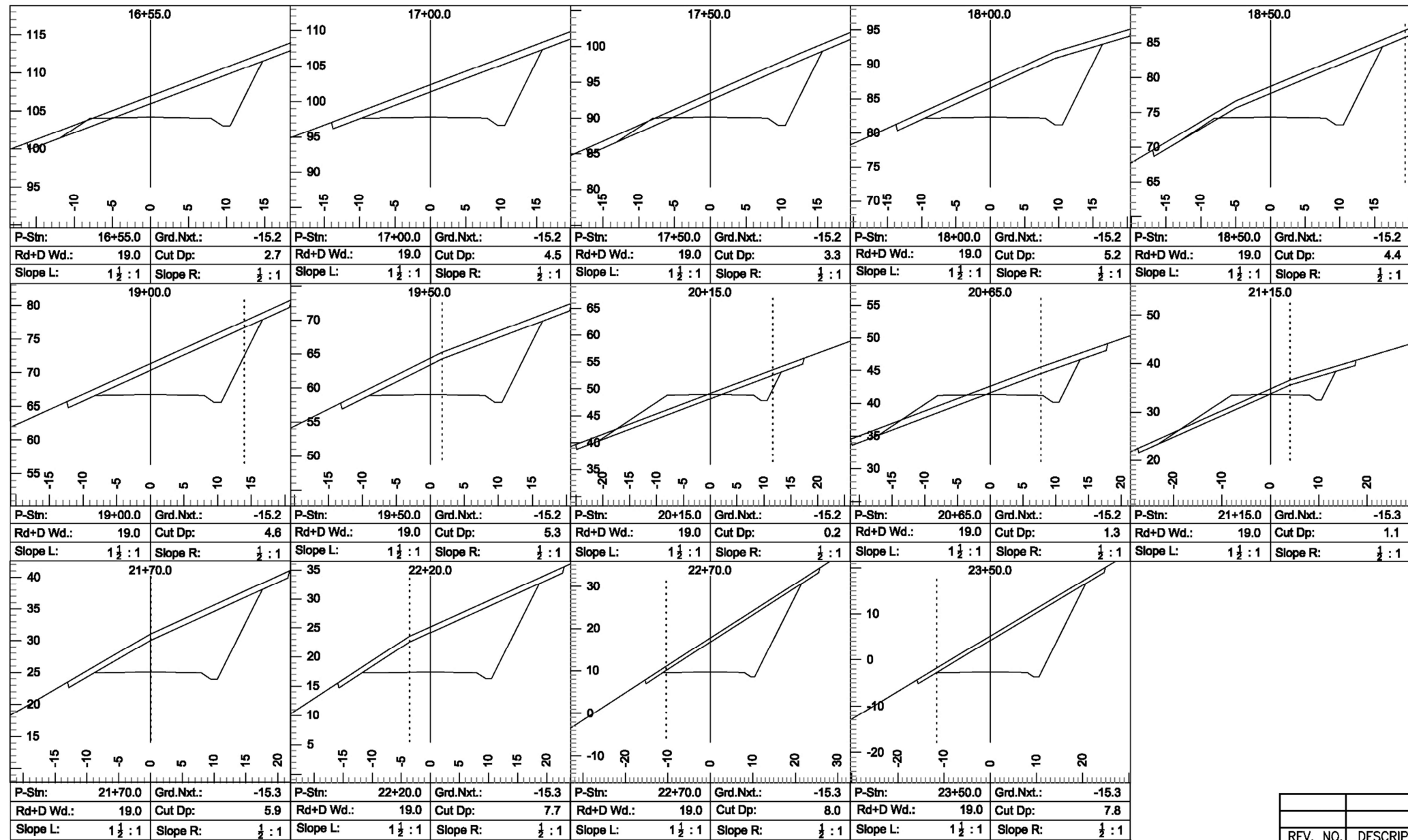

REV. NO.	DESCRIPTION	DATE	APPROVED
	UNITED STATES DEPARTMENT OF THE INTERIOR BUREAU OF LAND MANAGEMENT NW OREGON DISTRICT CASCADES FIELD OFFICE		
CAROLYN'S CRANES SPUR P1 CROSS SECTIONS CONSTRUCTION NOTES			
DRAWN: C LESNIAK		NOT TO SCALE	
DATE: 6/26/2020		SHEET 6 OF 24	

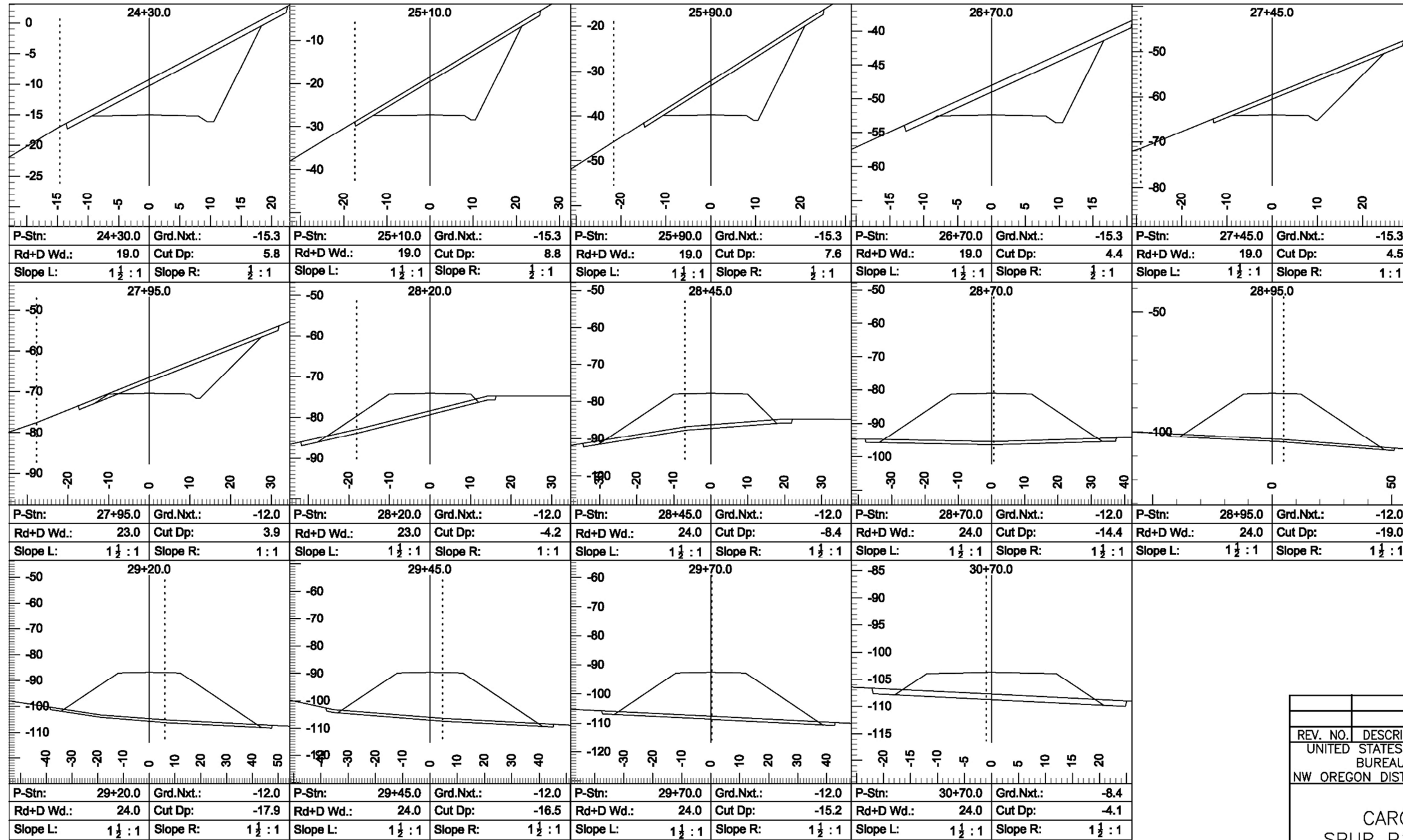

REV. NO.	DESCRIPTION	DATE	APPROVED
	UNITED STATES DEPARTMENT OF THE INTERIOR BUREAU OF LAND MANAGEMENT NW OREGON DISTRICT CASCADDES FIELD OFFICE		
CAROLYN'S CRANES SPUR P1 CROSS SECTIONS CONSTRUCTION NOTES			
DRAWN: C LESNIAK		NOT TO SCALE	
DATE: 6/26/2020		SHEET 7 OF 24	

GENERAL – 100

101 - Prewrite Conferences:

A prework conference will be held prior to the start of new construction and renovation operations. The Purchaser shall request the conference at least 48 hours prior to the time it is to be held. The conference will be attended by the Purchaser and/or his representatives, subcontractors and/or his or their representatives and the Authorized Officer and/or his representatives.

The purpose of the prework conference will be to review the required work, exhibits and specifications, and to establish a work schedule and a list of the Purchaser's representatives and subcontractors. A prework conferences shall be scheduled at a location agreed upon by all parties.

103 - Compaction equipment shall meet the following requirements:

103i - Other. Compaction equipment approved by the Authorized Officer.

CLEARING AND GRUBBING - 200

201 - This work shall consist of clearing, grubbing, removing and disposing of vegetation, debris, surface objects, and protruding obstructions within the clearing limits in accordance with these specifications and conforming to the lines, grades, dimensions and typical cross sections shown on the plans.

202 - Where clearing limits have not been staked, established by these specifications or shown on the plans, the limits shall extend (10) feet back of the top of the cut slope and (5) feet out from the toe of the fill slope.

203 - Clearing shall consist of the removal and disposal of trees, logs, rotten material, brush, and other vegetative materials and surface objects in accordance with these specifications and within the limits established for clearing as specified under Subsection 202.

204 - Grubbing shall consist of the removal and disposal of stumps, roots, and other wood material embedded in the ground and protruding obstacles remaining as a result of the clearing operation between the top of the cut slope and the toe of the fill slope.

210 - Disposal of clearing and grubbing debris shall be by scattering over government owned lands outside of established clearing limits in a manner acceptable to the Authorized Officer. The areas for such scattering shall have the prior approval of the Authorized Officer.

- 213 - No clearing or grubbing debris shall be left lodged against standing trees.

EXCAVATION AND EMBANKMENT - 300

- 301 - This work shall consist of excavating, overhaul, placement of embankments, backfilling, borrowing, leveling, ditching, grading, insloping, outsloping, crowning and scarification of the subgrade, compaction, disposal of excess and unsuitable materials, and other earth-moving work in accordance with these specifications and conforming to the lines, grades, dimensions, and typical cross sections shown on the plans.
- 302 - Excavation shall consist of the excavation of road and landing cut sections, borrow sites, backfilling, leveling, ditching, grading, compaction, and other earth moving work necessary for the construction of the roadway in accordance with these specifications and conforming to the lines, grades, dimensions, and typical cross sections shown on the plans.
- 305 - Embankment construction shall consist of the placement of excavated and borrowed materials, backfilling, leveling, grading, compaction, and other earth-moving work necessary for the construction of the roadway and landings in accordance with these specifications and conforming to the lines, grades, dimensions, and typical cross sections shown on the plans.
- 305a - Material used in the construction of embankment sections shall be free of stumps, cull logs, brush, muck, sod, roots, frozen material, and other deleterious materials and shall be placed and compacted as specified.
- 305b - Embankment materials shall be placed in successive parallel layers on areas cleared of stumps, cull logs, brush, sod, and other vegetative and deleterious materials, except as provided under Subsection 204. Roadway embankments of earth material shall be placed in horizontal layers not exceeding 8 inches in depth.
- 306 - Layers of embankment and final subgrade material as specified under Subsections 305a and 305b shall be moistened or dried to a uniform optimum moisture content suitable for maximum density and compacted to full width with compacting equipment conforming to requirements of Subsection 103i.
- 306a - Minimum compaction for each layer of embankment material placed at optimum moisture shall be 1 hour of continuous compacting for each 6 stations of road or fraction thereof.
- 306e - The final subgrade including landings and turnouts shall be compacted to full width with compacting equipment conforming to the requirements of 103i. Minimum

compaction shall be 1 hour of continuous compacting for each 6 stations of road or a fraction of as measured along the center line of the constructed road.

- 306f - Compaction of embankment layers placed as specified under Subsection 305b above shall be accomplished by routing construction equipment over full width of embankment structures.
- 315 - Borrow material required for construction of embankment or for other portions of the work shall be obtained from sources as shown on the plans.
- 316 - Borrow material from sources selected at the Purchaser's option shall be inspected and approved in writing by the Authorized Officer prior to placement.
- 320 - Ditches shall conform to the slope, grade, dimensions, and shape of the required cross section shown on the plans. Roots, stumps, rocks, and other projections shall be removed to form smooth, even slopes.
- 321 - Excess excavated, unsuitable, or slide materials shall not be disposed of on areas where the material will encroach on a stream course or other body of water. Such materials shall be disposed of in accordance with Subsection 321c. Materials not disposed of in this manner shall be retrieved and disposed of at the Purchaser's expense and at the direction of the Authorized Officer.
- 321c - End-dumping will be permitted for the placement of excess materials under Subsection 321 in designated disposal areas or within areas approved by the Authorized Officer. Watering, rolling, and placement in layers are not required. Materials placed shall be sloped, shaped, and otherwise brought to a visible condition acceptable to the Authorized Officer.
- 324 - Excavated material shall not be allowed to cover boles of standing trees to a depth in excess of 1 foot on the uphill side.
- 327 - The finished grading shall be approved by the Authorized Officer in segments or for the total project. The Purchaser shall give the Authorized Officer 3 days notice prior to final inspection of the grading operations.

PIPE CULVERTS - 400

- 401 - This work shall consist of furnishing and installing pipe culverts and other erosion control devices in accordance with these specifications and conforming to the lines, grades, dimensions, and typical cross sections shown on the plans. Individual lengths and locations are approximate; final lengths and locations will be determined by the Authorized Officer upon installation of the appurtenance structures. Additional pipe and erosion control devices may be required at the option of the

Authorized Officer, in which case a reduction in the total purchase price shall be made to offset the cost of furnishing and installing such items. Costs will be based upon the unit prices set forth in the current BLM Timber Appraisal Production Cost Schedule.

- 403 - Grade culverts shall have a gradient of from 2 percent to 4 percent greater than adjacent road grade. Grade culverts shall be skewed down grade 30 degrees as measured from the perpendicular to the centerline unless otherwise specified on the plans.
- 406 - Coupling bands shall conform to the requirements of AASHTO M 36 and AASHTO M 218 or AASHTO M 274 with the exception of band widths and the "Hugger"-type band which shall conform to the details, dimensions, and typical diagram shown on the plans.
- 408 - Pipe culverts and pipe-arch culverts shall be placed on the bed starting at the downstream end with the inside circumferential laps pointing downstream and with the longitudinal laps at the side or quarter points. Coupling bands of the type required under these specifications shall be installed so as to provide the circumferential and longitudinal strength necessary to preserve the pipe alignment, prevent separation of the pipe sections, and minimize infiltration of fill material.
- 410 - Pipe shall be unloaded and handled with reasonable care. If the Authorized Officer determines any structure is damaged to the extent that it is unsuitable for use in the road construction, it shall be replaced at the Purchaser's expense.
- 411 - Trenches necessary for the installation of pipe culverts shall conform to the lines, grades, dimensions, and typical diagram and the Culvert Installation Detail Sheet.
- 413 - Pipe culverts and pipe-arch culverts shall be bedded on a fine readily compactable soil material having a depth of not less than 6 inches as shown on plans. Foundation material shall be of uniform density throughout the length of the structure and shall be shaped to fit the pipe.
- 415 - Inspection of pipe culverts having a diameter of 48 inches and pipe-arch culverts having a height of 40 inches or a cross sectional area of 13 or larger shall be made before backfill is placed. Culverts found to be out of alignment or damaged shall be replaced, reinstalled or repaired as directed by the Authorized Officer at the Purchaser's expense.
- 416 - Side-fill material for pipe culverts shall be placed within 1 pipe diameter, or a minimum of 2 feet, of the sides of the pipe barrel, and to 1 foot over the pipe fine readily compactable soil or granular fill material free of excess moisture, muck, frozen material, roots, sod, or other deleterious or caustic material and devoid of

rocks or stones of sizes which may impinge upon and damage the pipe or otherwise interfere with proper compaction.

- 419 - The pipe culvert after being bedded and backfilled as required by these specifications shall be protected by a 2-foot cover of fill before heavy equipment is permitted to cross the drainage structure. Removal of the protection fill shall be as directed by the Authorized Officer.
- 426 - Culvert markers consisting of 5 foot steel fence posts painted green with white top, shall be furnished, fabricated, and installed by the Purchaser at grade culverts as shown on the plans and as directed by the Authorized Officer.
- 427 - Record culvert sizes, lengths and location (actually installed) on a copy of the culvert list. This culvert list shall be furnished to the Authorized Officer.
- 428 - Remove and dispose of old culverts in a legal manner, and for any fees required. The Purchaser shall remove the old culverts from the work site within three 3 working days of completion of the culvert replacement work for each road prior to road acceptance.
- 429 - Keep the excavation site dewatered so that the installation of culverts is completed under dry conditions. Dispose of excess water by using pumping or natural drainage ways near the site in a manner that will avoid damage to adjacent property. Diversion streams shall not be returned to the natural channel until all in-stream work has been completed.

CULVERT SUMMARY																	
Culvert Locations											Culvert Markers	Downspout (4)				Remarks (6)	
Designed						As Built						Type	Diameter (in)	Length	Type of Elbow (5)		
Road No.	Station (1)	Diameter (in)	Material (2)	Length (ft) (1)	Skew Angle	Installation Type (3)	Road No.	Station	Diameter (in)	Gage							Length (ft)
P 1/7-2E-15.1	4+00	24	CPP	30	0	3	P 1/7-2E-15.1					Inlet				BLM to flag location after Sec. 200 & 300 accepted	
P 1/7-2E-15.1	8+20	24	CPP	30	0	3	P 1/7-2E-15.1					Inlet				BLM to flag location after Sec. 200 & 300 accepted	
P 1/7-2E-15.1	16+00	18	CPP	40	30	2	P 1/7-2E-15.1					Inlet	1	18	10	1	BLM to flag location after Sec. 200 & 300 accepted
P 1/7-2E-15.1	19+00	18	CPP	30	30	2	P 1/7-2E-15.1					Inlet	1	18	10	1	BLM to flag location after Sec. 200 & 300 accepted
P 1/7-2E-15.1	22+00	18	CPP	30	30	2	P 1/7-2E-15.1					Inlet	1	18	10	1	BLM to flag location after Sec. 200 & 300 accepted
P 1/7-2E-15.1	25+00	18	CPP	30	30	2	P 1/7-2E-15.1					Inlet	1	18	10	1	BLM to flag location after Sec. 200 & 300 accepted
P 1/7-2E-15.1	34+00	18	CPP	30	0	3	P 1/7-2E-15.1					Inlet					BLM to flag location after Sec. 200 & 300 accepted
P 1/7-2E-15.1	39+00	18	CPP	30	0	3	P 1/7-2E-15.1					Inlet					BLM to flag location after Sec. 200 & 300 accepted
P 1/7-2E-15.1	43+00	24	CPP	40	0	3	P 1/7-2E-15.1					Inlet					BLM to flag location after Sec. 200 & 300 accepted
P 1/7-2E-15.1	46+25	24	CPP	30	0	3	P 1/7-2E-15.1					Inlet					BLM to flag location after Sec. 200 & 300 accepted
P 1/7-2E-15.1	55+00	18	CPP	30	0	3	P 1/7-2E-15.1					Inlet					BLM to flag location after Sec. 200 & 300 accepted
P 2/7-2E-15.2	4+00	18	CPP	30	0	3	P 2/7-2E-15.2					Inlet					BLM to flag location after Sec. 200 & 300 accepted
P 2/7-2E-15.3	0+50	18	CPP	40	0	3	P 2/7-2E-15.3					Inlet					BLM to flag location after Sec. 200 & 300 accepted
P 4/7-2E-14	1+80	18	CPP	30	0	3	P 4/7-2E-14					Inlet					BLM to flag location after Sec. 200 & 300 accepted
P 5/7-2E-23.3	2+25	18	CPP	30	0	3	P 5/7-2E-23.3					Inlet					BLM to flag location after Sec. 200 & 300 accepted

- (1) Designed culvert lengths and locations are approximate.
- (2) Material: ASP=Aluminized Squash Pipe CPP=Corrugated Poly Pipe CMP=Corrugated Metal Pipe
- (3) See Culvert Installation sheet.
- (4) Downspout Types: 1 = Full Round 2 = Half Round 3 = Rectangular Flume
- (5) Elbow Types: 1 = Conventional or Fabricated 2 = Turner Type 3 = Slip Joint
- (6) Include special sections, structures, headwalls, footings, and other data.

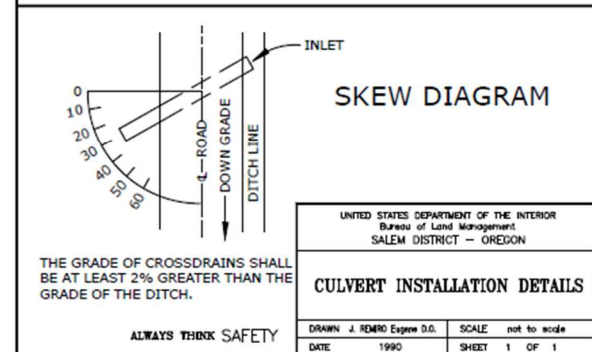
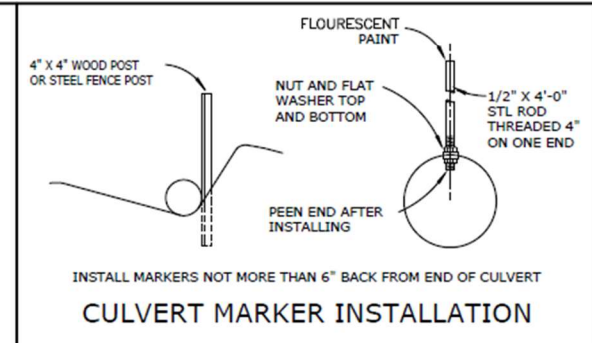
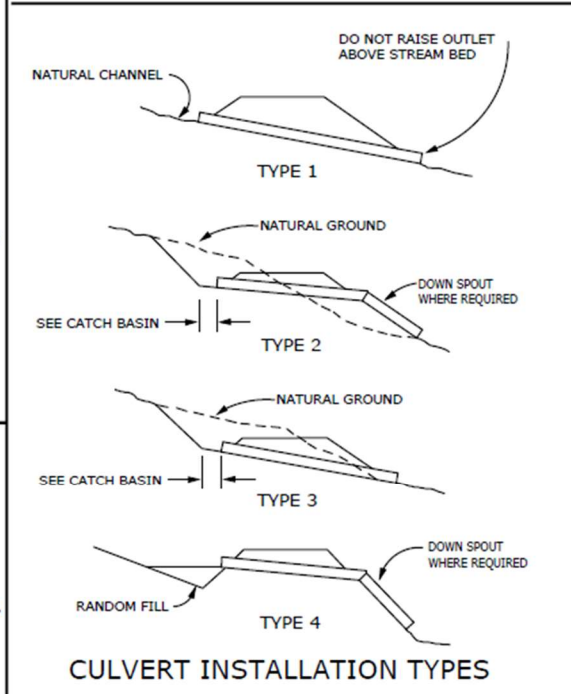
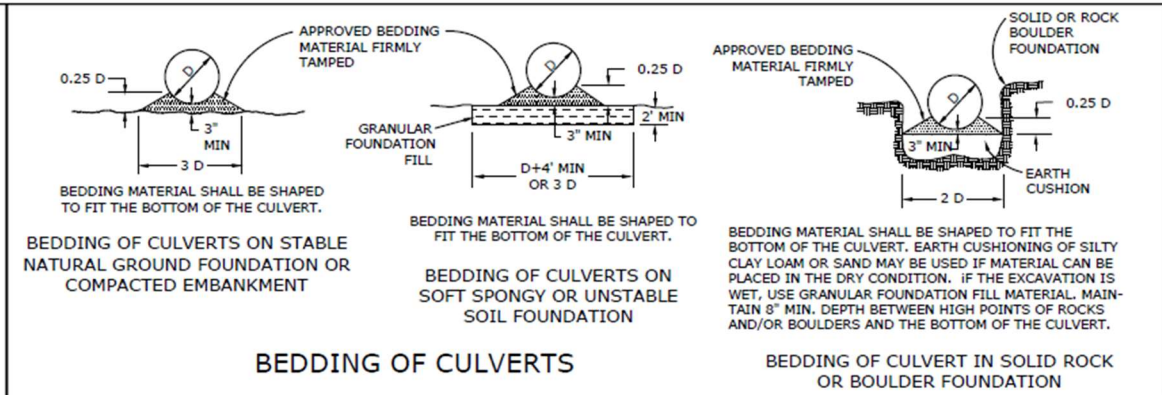
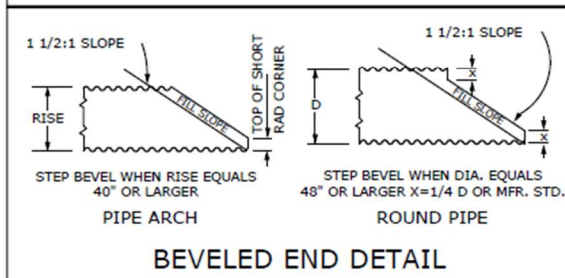
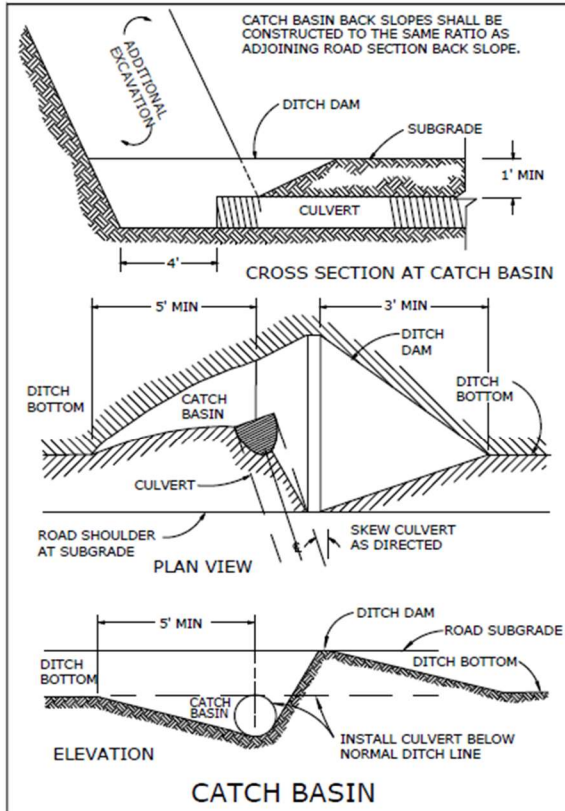

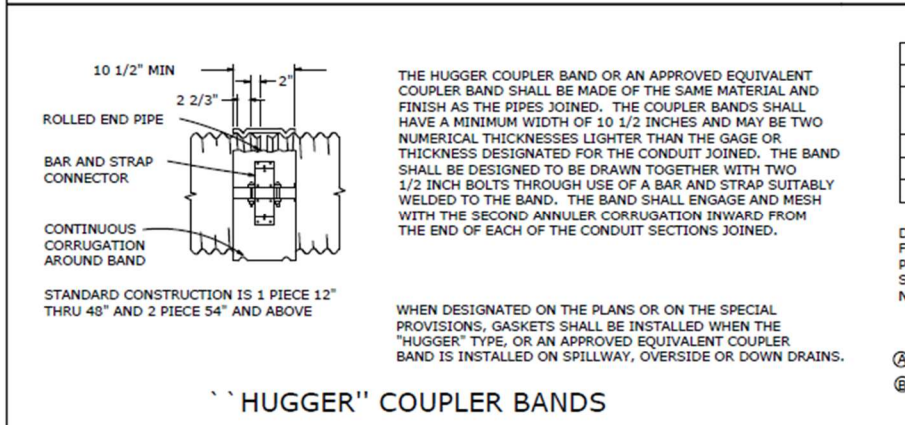
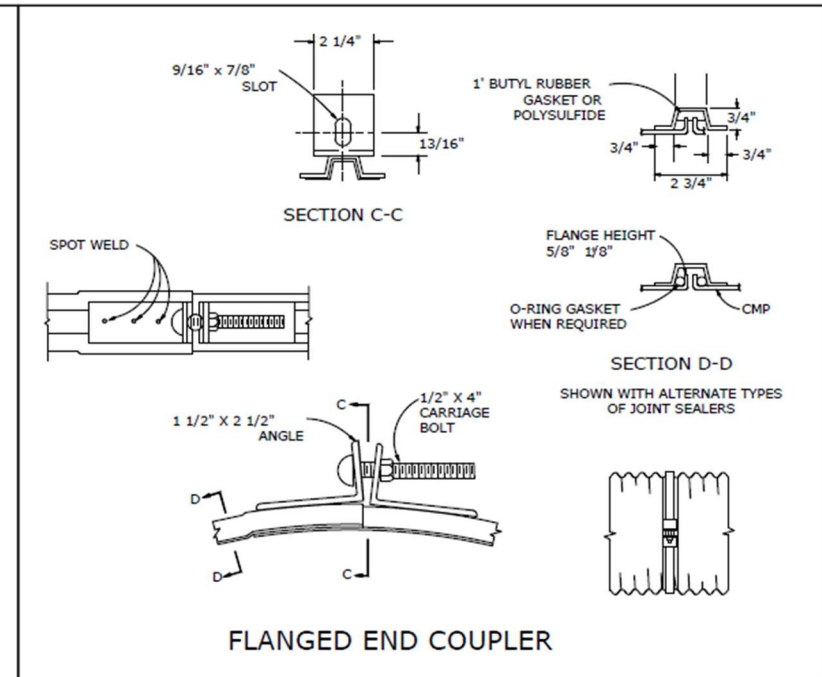
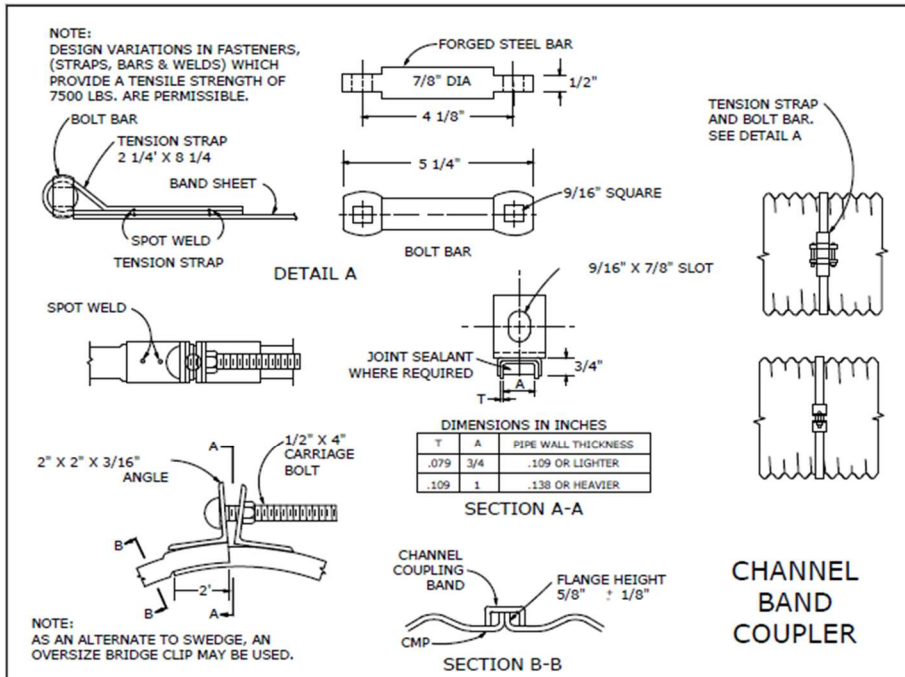

CULVERT SIZE INCHES	STANDARD COUPLER BANDS								FLAT-DIMPLED			
	CORRUGATED				CORRUGATED				WIDTH	NO. OF ROWS OF DIMPLES	NO. OF BOLTS	
	STD. ANNULAR	HELCAL	3" x 1"	6" x 1"	3" x 1"	6" x 1"						
UNDER 18	7	2	7	2	7	2	7	2	10 1/2	2	2	2
18 TO 54	12	3	12	3	14	3	18	3	10 1/2	2	3	2
OVER 54	24	5	24	5	24	5	24	4	16 1/2	4	5	4

DATA IN THIS BLOCK DOES NOT APPLY TO PERFORATED PIPE UNDERDRAIN. FOR BANDS WITH "PUNCH-OUT" TYPE CONNECTIONS, 2 BOLTS ARE PERMISSIBLE FOR EACH LAP. BANDS SHALL LAP 1/2 WIDTH ONTO EACH SECTION OF PIPE AND MUST FULLY ENCIRCLE THE JOINT FORMING A NEARLY WATERTIGHT CONNECTION.

- (A) BANDS WITH ANGLES
- (B) BANDS WITH TENSION TYPE CONNECTIONS

ALWAYS THINK SAFETY

UNITED STATES DEPARTMENT OF THE INTERIOR Bureau of Land Management SALEM DISTRICT - OREGON	
CULVERT BAND DETAILS	
DRAWN J. REMRO Dgns D.O.	SCALE not to scale
DATE 1990	SHEET 1 OF 1

RENOVATION AND IMPROVEMENT OF EXISTING ROADS - 500

- 501 - This work shall consist of reconditioning and preparing the roadbed and shoulders, minor excavation and/or embankment, cleaning and shaping drainage ditches, trimming vegetation from cut and embankment slopes, and cleaning and repairing drainage structures of existing roads in accordance with these specifications as shown on the plans.
- 502 - The existing road surface shall be bladed and shaped to the lines, grades, dimensions, and typical cross sections shown on the plans.
- 504 - Existing road surface shall be uniformly moistened or dried to the optimum moisture content suitable for maximum density and compacted to full width with equipment conforming to requirements of Subsections 103i.
- 504a - Minimum compaction required shall be 1 hour of continuous rolling for each 6 stations of road, or fraction thereof, as measured along the centerline per layer of material.
- 506 - The inlet end of existing drainage structures shall be cleared of vegetative debris and boulders that are of sufficient size to obstruct normal stream flow. Pipe inverts shall be cleared of sediment and other debris lodged in the barrel of the pipe. The outflow area of pipe structures shall be cleared of rock and vegetative obstructions which will impede the structure's designed outflow configuration. Catch basins shall conform to the lines, grade, dimensions, and typical diagram shown on the plans.
- 507 - Existing and new drainage structures listed in the Culvert Summary in Section 400 shall be replaced and placed with structures of the type, gauge, diameter, and length shown on the plans and in accordance with the placement requirements set forth under Section 400 of these specifications.
- 509 - The finished grading shall be approved by the Authorized Officer 3 days prior to surfacing operations. The Purchaser shall give the Authorized Officer 3 days notice prior to final inspection of the grading operations.

WATERING - 600

- 601 - This work shall consist of furnishing and applying water required for the compaction of embankments, roadbeds, backfills, base courses, surface courses, finishing and reconditioning of existing roadbeds, laying dust, or for other uses in accordance with these specifications.

AGGREGATE BASE COURSE - 1000
CRUSHED ROCK MATERIAL

- 1001 - This work shall consist of furnishing, hauling, and placing one or more lifts of crushed rock material on roadbeds approved for placing crushed rock material, in accordance with these specifications and conforming to the dimensions and typical cross sections shown on the plans. Material not conforming to these specifications will be rejected and shall be removed from the road at the purchaser's expense.

- 1002a - Crushed rock materials may be obtained from commercial sources selected by the Purchaser at his option and expense providing that the rock materials selected comply with the specifications in this section.

- 1003 - Crushed rock material produced from gravel shall have 3 manufactured fractured faces on 65 percent, by weight, of the material retained on the No. 4 sieve.

- 1004 - Crushed rock materials shall consist of hard durable rock fragments conforming to the following gradation requirements:

AGGREGATE BASE COURSE
CRUSHED ROCK MATERIAL

Percentage by Weight Passing Square Mesh Sieves
 (AASHTO T 11 & T 27)
 GRADATION

Sieve Designation	F
(6) -inch	-
3-inch	100
2-inch	65-95
1 1/2-inch	-
1-inch	-
3/4-inch	28-70
1/2-inch	-
3/8-inch	-
No. 4	10-35
No. 8	-
No. 10	-
No. 30	5-22
No. 40	-
No. 200	3-10

- 1006 - Crushed rock material shall show durability value of not less than 35, as determined by AASHTO T 210.
- 1008 - If additional binder or filler is necessary in order to meet the grading or plasticity requirements, or for satisfactory bonding of the material, it shall be uniformly blended with the crushed rock material at the crushing and screening plant prior to placing on the road, unless otherwise agreed. The material for such purposes shall be obtained from sources approved by the Authorized Officer and shall be free from stones, vegetative matter, and other deleterious materials.
- 1008a - Each layer of crushed rock material shall be thoroughly mixed on the roadbed by alternately blading, to full depth, until a uniform mixture has been obtained. The mixture shall then be spread to full width. When completed, the spreading shall produce a surface which is smooth, presents uniform shoulder lines, and conforms to the specified cross section.
- 1009 - The roadbed, as shaped and compacted under Sections 300 and 500 of these specifications, shall be approved by the Authorized Officer prior to placement of crushed rock materials.
- 1010 - Crushed rock materials shall be placed and processed on the approved roadbed in accordance with these specifications and conforming to the lines, grades, dimensions, and typical cross sections shown on the plans and compacted in layers not to exceed 4 inches in depth. When more than one layer is required, each shall be shaped, processed, compacted, before the succeeding layer is placed. Irregularities or depressions that develop during compaction of the top layer shall be corrected by loosening the material at these places and adding or removing crushed rock material until the surface is smooth and uniform.
- 1010a - Crushed rock material used to repair or reinforce a soft, muddy, frozen, yielding, or rutted roadbed shall not be construed as surfacing under this specification.
- 1011 - Crushed rock material shall be compacted by routing construction and hauling equipment over the full width of each layer placed.
- 1012 - Each layer of crushed rock material shall be placed, processed, shaped, moistened or dried to a uniform moisture content suitable for maximum compaction, and compacted to full width by compaction equipment conforming to the requirements of Subsection 103i. Minimum compaction shall be deemed adequate when the surface can withstand five passes of a truck with H-20 loading without appreciable deformation.
- 1013 - Each layer of crushed rock material for base placed, processed, and shaped as specified shall be uniformly moistened or dried to the optimum moisture content

suitable for maximum density and compacted to full width until a uniform density of not less than 95 percent of the maximum density is attained as determined by AASHTO T 99, Method D.

AGGREGATE SURFACE COURSE - 1200
CRUSHED ROCK MATERIAL

- 1201 - This work shall consist of furnishing, hauling, and placing one or more layers of crushed rock material on base courses approved for placing crushed rock material in accordance with these specifications and conforming to the dimensions and typical cross sections shown on the plans. Material not conforming to these specifications will be rejected, and shall be removed from the road at the purchaser's expense.
- 1202a - Crushed rock materials used in this work may be obtained from commercial sources selected by the Purchaser at his option and expense, providing the rock materials furnished comply with the specifications.
- 1203 - When crushed rock material is produced from gravel, not less than 65 percent by weight of the particles retained on the No. 4 sieve will have 3 manufactured fractured faces.
- 1204 - Crushed rock material shall consist of hard durable rock fragments conforming to the following gradation requirements:

AGGREGATE SURFACE COURSE
CRUSHED ROCK MATERIAL

Percentage by weight passing square mesh sieves
 AASHTO T 11 & T 27
 GRADATION

Sieve Designation	C
1-1/2-inch	100
1-inch	-
3/4-inch	50-90
1/2-inch	-
No. 4	25-50
No. 8	-
No. 30	-
No. 40	5-25
No. 200	2-15

- 1206 - Crushed rock material shall show a durability value of not less than 35 as determined by AASHTO T210.
- 1212 - Each layer of crushed rock material placed, processed, and shaped as specified shall be moistened or dried to a uniform moisture content suitable for maximum compaction and compacted to full width by compacting equipment conforming to the requirements of Subsection 103i. Minimum compaction shall be 1 hour of continuous compacting for each 6 stations, or fraction thereof.
- 1213 - Each layer of crushed rock material placed, uniformly processed, and shaped as specified shall be uniformly moistened or dried to the optimum moisture content suitable for maximum density and compacted to full width until a uniform density of not less than 95 percent of maximum density is attained as determined by AASHTO T 99, Method C or D.

EROSION CONTROL - 1700

- 1701 - This work shall consist of measures to control soil erosion or water pollution during the construction operation through the use of berms, dikes, dams, sediment basins, fiber mats, netting, gravel, mulches, grasses, slope drains, and other erosion control devices or methods in accordance with these specifications and conforming to the lines, grades, dimensions and typical cross sections shown on the plans.
- 1704 - The erosion control provisions specified under this Subsection shall be coordinated with the Soil Stabilization requirements of Section 1800.
- 1708a - Road segments not completed during dry weather periods shall be winterized, by providing a well-drained roadway using water bars, maintaining drainage, and performing additional measures necessary to minimize erosion and other damage to the roadway, as directed by the Authorized Officer. Portions of roads not having surface rock in place will be blocked or barricaded to prevent vehicular traffic.

SOIL STABILIZATION – 1800

- 1801 - This work shall consist of seeding and mulching on designated cut, fill, borrow, disposal, and special areas in accordance with these specifications. This work is required for road acceptance under Section 18 of this contract.
- 1802a - Soil stabilization work consisting of seeding and mulching shall be performed on disturbed areas and specials areas in accordance with these specifications and as shown on the plans.

- 1803 - Soil stabilization work as specified under Subsection 1802a shall be performed during the following seasonal periods:

From: September 15	To: October 30
From: March 1	To: April 31

If soil stabilization of disturbed areas is not completed by the specified fall date, the Purchaser shall treat disturbed areas and then complete the requirements of Section 1800 the next construction season. The Authorized Officer may modify the above seasonal dates to conform to existing weather conditions and changes in the construction schedule.

- 1803a - The Purchaser shall begin soil stabilization work within 10 days of the starting work date when notified by the Authorized Officer.
- 1804 - The Purchaser shall provide native grass/forb seed or other plant materials for this project.

All seed provided must meet corresponding germination, purity, and weed-content requirements:

Species	Germination Min. %	Purity Min. %	Weed Content Max. %
Blue Wildrye (Elymus Glaucus)	75	99	1

The Purchaser shall furnish the Authorized Officer a Seed Test Result for the mix from a certified seed testing lab Oregon State University, Crop Certification Service, which shall include: date of test; lot number of each kind of seed; and results of tests as to name, percentages of purity and of germination, weed species and percentage of weed content, for each kind of seed furnished and, in case of mixture, the proportions of each kind of seed. The seed must have been tested within the last 6 months to be accepted for use on this contract. The Purchaser shall provide in writing that the seed mixture is free of noxious weed species.

- 1806a - Additional soil stabilization work consisting of seeding and mulching, may be required at the option of the Authorized Officer. Providing the additional stabilization is not due to Purchaser negligence as specified in Sec. 12 of the contract, a reduction in the total purchased price shall be made to offset the cost of furnishing and applying such additional stabilization material. Cost shall be based upon the unit price set forth in the current BLM Timber Appraisal Production Cost Schedule.

- 1808 - Mulch materials conforming to the requirements of Subsection 1808a shall be furnished by the Purchaser and applied in accordance with Subsection 1812.
- 1808a - Straw mulch shall be certified weed free from commercial grain fields and native grass fields. Straw mulch shall be from oats, wheat, rye, or other approved grain crops and shall be free from, mold, or other objectionable material. Straw mulch shall be in an air-dry condition and suitable for placement.
- 1809 - Mulch material shall be delivered to the work area in a dry state. Material found to be wet will not be accepted. Material to be used in the mulching operation may be stockpiled along the road designated for treatment provided that it is maintained in a dry state and has the approval of the Authorized Officer.
- 1812 - The Purchaser shall furnish and apply to the area designated for treatment as shown on the plans, a mixture of grass seed and mulch, material at the application rate to be determined by the Authorized Officer based on visual observation of trial applications.
- 1814 - The Purchaser may reduce the application rate on partially covered slopes and refrain from application on areas already well stocked with grass or on rock surfaces as determined by the Authorized Officer.
- 1815 - The seed and mulch materials shall be placed by the dry method in accordance with the requirements set forth in Subsection 1815b.
- 1815b - Dry Method - Blowers, mechanical seeders, seed drills, landscape seeders, cultipacker seeders, fertilizer spreaders, or other approved mechanical seeding equipment may be used when seed and fertilizer are to be applied in dry form.
- 1821 - Mulch that collects at the end of culverts or accumulates to excessive depths on the slopes shall be evenly spread by hand methods, as directed by the Authorized Officer.

ROADSIDE BRUSHING - 2100

- 2101 - This work shall consist of the removal of vegetation from the road prism - variable distance, and inside curves in accordance with these specifications and conforming to the lines, grades, dimensions, and typical cross sections shown on the Roadside Brushing Detail Sheet of this exhibit, at designated locations as shown in the plans.
- 2102 - Roadside brushing may be performed mechanically with self powered, self-propelled equipment and or manually with hand tools, including chain saws.
- 2103 - Vegetation cut manually or mechanically less than 6 inches in diameter at D.B.H.O.B. shall be cut to a maximum height of 2 inches above the ground surface or above obstructions such as rocks or stumps on cut and fill slopes and all limbs below the 2 inch area will be severed from the trunk.
- 2109 - Debris resulting from this operation shall be scattered downslope from the roadway. Debris shall not be allowed to accumulate in concentrations. Debris in excess of foot in length and 2 inches in diameter shall not be allowed to remain on cut slopes, ditches, roadways or water courses, or as directed by the Authorized Officer.
- 2115 - Mechanical brush cutters shall not be operated when there are people and occupied vehicles within 400 feet of the immediate operating area.
- 2116 - Traffic warning signs shall be required at each end of the work area. Signs shall meet the requirements of the Manual on Uniform Traffic Devices.

ROADSIDE BRUSHING DETAIL SHEET

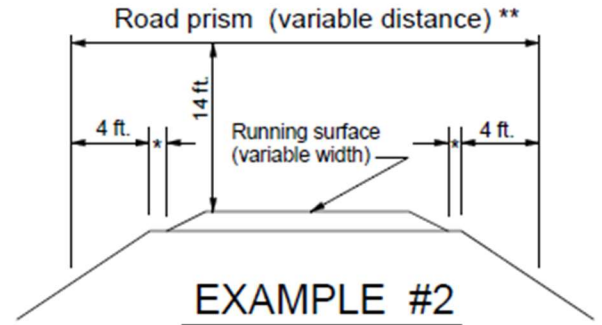
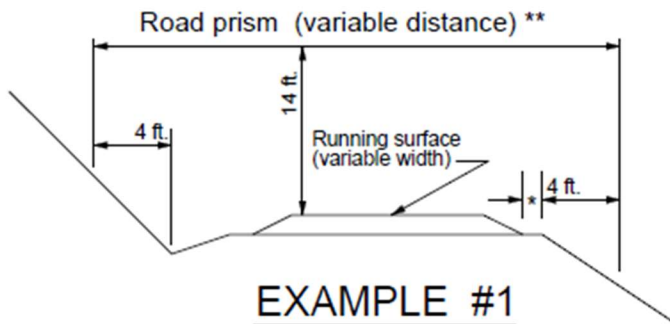

(NO SCALE)

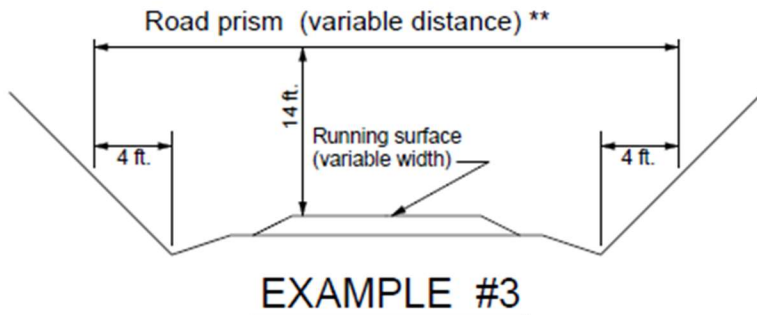

- * Variable distance between running surface and start of fill slope
- ** All areas within the variable distance shall be free of all vegetation capable of growing one (1) foot in height or higher and all overhanging limbs and branches 14 feet in elevation above the running surface

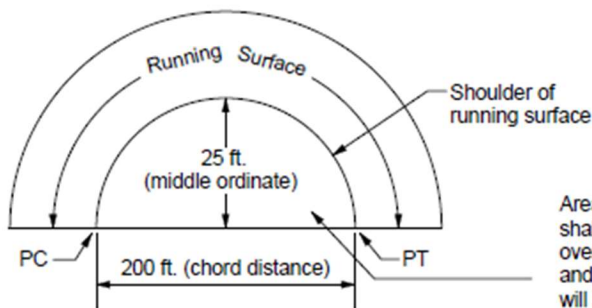

SIGHT DISTANCE DIAGRAM

Area to be cut:
 shall be free of
 overhanging limbs
 and all vegetation
 will be cut to a
 maximum height
 of one (1) foot.

NOTE:

Prior to beginning roadside brushing the purchaser shall establish a control section in a location determined by the Authorized Officer. This section will be used to physically and visually establish acceptable cutting and cleanup standards to be used for the remaining roadside brushing.

ROAD MAINTENANCE SPECIFICATIONS

General road maintenance specifications are designated by numeric symbols according to the type of work performed as follows:

SECTION	DESCRIPTION
	Road Use and Maintenance Maps
3000	General
3100	Operational Maintenance
3200	Seasonal Maintenance
3300	Final Maintenance
3400	Other Maintenance
3500	Stabilization



UNITED STATES DEPARTMENT OF THE INTERIOR
 Bureau of Land Management
 Cascades Field Office - Northwest Oregon District
Carolyn's Cranes - Exhibit D
Road Use and Maintenance Map- Page 1 of 1
 T. 7 S. - R. 2 E., Section 15, 23, W.M.

- ▶ Road Segment Break
- ⚡ Gate
- ⊘ Existing Culvert
- ☆ Culvert to Install
- ▬ Approved Haul Route - Purchaser Maintenance
- ▬ County Road
- ▬ Existing Road
- ▬ Haul Routes
- ▬ Stream
- ▭ Carolyn's Cranes Harvest Area
- ▭ Bureau of Land Management
- ▭ Private or Other Owner

No warranty is made by the Bureau of Land Management as to the accuracy, reliability or completeness of these data for individual use or aggregate use with other data. Original data was compiled from multiple source data and may not meet U.S. National Mapping Accuracy Standard of the Office of Management and Budget.

Feet
 0 1,000 2,000

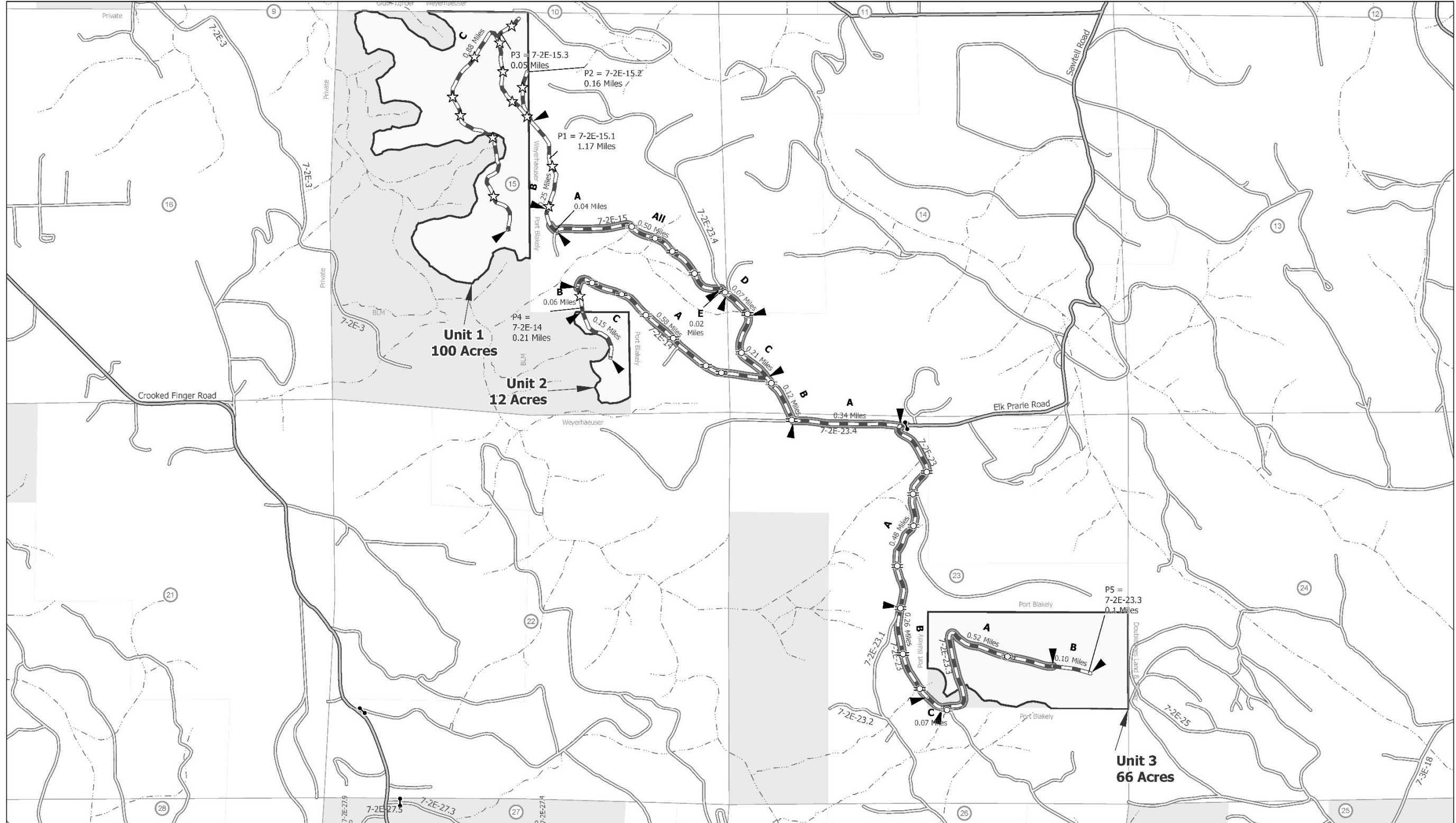

GENERAL - 3000

- 3001 The Purchaser shall be required to maintain all roads as shown on the Exhibit D Road Use and Maintenance map of this contract in accordance with Sections 3000, 3100, 3200, 3300, and 3400 of this exhibit.
- 3002 The Purchaser shall maintain the cross section of existing dirt or graveled roads to the existing geometric standards. Any roads required to be constructed, improved, or renovated under terms of this contract shall be maintained to the geometric standards required in Exhibit C of this contract.
- 3003 The minimum required maintenance on any roads shall include the provisions specified in Subsections 3101, 3104, and 3105.
- 3004 The Purchaser shall be responsible for providing timely maintenance and cleanup on any road(s) with logging units substantially completed prior to moving operations to other roads. The maximum length of non-maintained or non-cleanup of the road prism shall not exceed the sum of one (1) mile at any time. Release of maintenance requirements may be granted, upon written request, when the conditions specified in Sections 3300 and 3400 are met satisfactorily.

OPERATIONAL MAINTENANCE - 3100

- 3101 The Purchaser shall blade and shape the road surface and shoulders with a motor grader. Banks shall not be undercut. Back blading with tractors or similar equipment will be allowed only around landings and other areas when approved by the Authorized Officer.
- 3102 The Purchaser shall furnish and place aggregate conforming to the requirements in Section 1000 and 1200 of Exhibit C of this contract on the roadway as necessary to maintain the dimensions and typical cross sections shown on the Exhibit C plans and at locations and in the amounts designated by the Authorized Officer.
- This aggregate shall be used to repair surface failures and areas of depleted surface depth excluding damages covered by Section 12 of this contract. The aggregate shall be furnished, hauled, placed, spread, and compacted by use of dump trucks, water trucks, and motor grader or similar equipment.
- 3103 The purchaser shall maintain established berms and place additional berms using adjacent material where needed to protect fills as directed by the Authorized Officer.
- 3104 The purchaser shall perform other road cleanup including removal of debris, fallen timber, bank slough, and slides which can practicably be accomplished by a motor grader, rubber tired front end bucket loader, rubber tired backhoe or comparable equipment, and by the use of hand tools.
- 3105 The Purchaser shall be responsible for maintaining normal flow in drainage structures. This includes cleaning out drainage ditches, catch basins, clearing pipe inverts of sediment and other debris lodged in the barrel of the pipe, and maintaining water dips and water-bars using equipment specified in Subsection 3104 and other culvert cleaning and flushing equipment.

3106 The Purchaser shall be responsible for repair and replacement of all materials eroded from road shoulders and fill slopes, up to fifteen station yards in quantity, at any one site. This work includes unlimited multiple sites on all roads required to be maintained by the Purchaser. Prior to repair and replacement of eroded material exceeding fifteen station yards at any one site, the Purchaser and the Authorized Officer or their Authorized Representatives shall agree in writing, in the field, to the quantity of material, borrow source and method of repair. Work may commence immediately after agreement.

Upon completion of agreed upon work, a reduction in timber sale purchase price will be made to offset the cost of the work based upon current BLM Road Cost Guide. Adjustments in purchase price for completed work shall be made as necessary and no less than once per year when actual work is ongoing.

3107 The Purchaser shall cut or trim trees and brush which obstructs vision or prevents the safe passage of traffic along the traveled way when directed by the Authorized Officer.

The Purchaser shall also cut trees or brush encroaching on the road prism that are a result of his activities or winter damage during the contract period. Disposal of such vegetative material shall be in accordance with Section 2100 of Exhibit C.

3108 The Purchaser shall avoid fouling gravel or bituminous surfaces through covering with earth and debris from side ditches, slides or other sources. The Purchaser shall also avoid blading surfacing material off the running surface of the roadway. Skidding of logs on the roadway in or outside designated logging units is not authorized without prior written approval by the Authorized Officer. Repair required caused by such skidding activity is not considered maintenance and shall be repaired at the Purchaser's expense.

SEASONAL MAINTENANCE - 3200

3201 The Purchaser shall perform preventative maintenance at the end of Purchaser's hauling each season and during non-hauling periods which occur between other operations on the contract area. This includes requirements specified in Section 3100.

3202 The purchaser shall perform and complete maintenance specified in Sections 3000, 3100, and 3200 on all roads maintained by him, prior to October 1 each year, except as specified in Subsection 3203, after initial commencement of construction or logging operations. Thereafter, all roads shall have continuous preventive maintenance and road cleanup until suspension of seasonal operations. This includes all roads used and not used during the proceeding operating seasons.

3203 The Purchaser shall complete road cleanup and maintenance, as specified in Section 3100, at the completion of logging operations on any roads located in an area separate from the area where logging activities will resume.

3204 The Purchaser shall be responsible for performing post storm inspections and maintenance during the winter season to minimize erosion and potential road or watershed damage.

FINAL MAINTENANCE - 3300

3301 The Purchaser shall complete final maintenance and/or damage repairs on all roads used under terms of their contract within thirty 30 calendar days following the completion of hauling and in accordance with Sec. 16(b) of this contract. This work shall include any maintenance and/or damage repairs specified in Sections 3000, 3100, and 3200 necessary to meet the conditions specified in Subsection 3002 and shall be executed in accordance with Subsection 3302 of this section.

The Authorized Officer may grant acceptance of Purchaser's maintenance responsibility in part where certain individual roads or road segments are no longer of any use to the Purchaser's remaining removal operations, providing that all contract requirements as specified under Sec. 16(b), Special Provisions Sections 3000, 3100, 3200 and 3300 of the maintenance specifications have been completed and a relinquishment of cutting and removal rights on cutting units tributary to these roads is signed by the Purchaser. Request for partial acceptance must be submitted in writing by the Purchaser.

3302 The Purchaser shall perform final road maintenance only when weather or soil moisture conditions are suitable for normal maintenance equipment operations as determined by the Authorized Officer.

If final maintenance is delayed after the date required in Subsection 3301 of this contract by adverse soil moisture or unsuitable equipment operating conditions, the Purchaser will be notified by the Authorized Officer when soil moisture and equipment operating conditions are suitable. The Purchaser shall then be required to complete final maintenance within 30 days.

OTHER MAINTENANCE - 3400

3401 The Purchaser shall repair any damage to road surfaces that was specified under Subsection 3108. This repair includes restoring the roadway to the designed standard and replacement of surfacing with approved surface material. This repair is not limited to use of equipment specified in Subsection 3104.

STABILIZATION – 3500

3501 Stabilization shall consist of installing water bars, drain dips, placement of slash and blocking road from access by vehicles. This work is required for road acceptance under Section 18 of this contract.

3503 Stabilization shall be performed on existing roads in accordance with these specifications, and as shown on the plans at the following locations:

Road No. or Site	From Sta./M.P.	To Sta./M.P.	Comment
P1/7-2E-15.1*	0.29 M.P.	1.19 M.P.	Barricade, drivable waterbar
P2/7-2E-15.2*	0.00 M.P.	0.16 M.P.	Barricade, drivable waterbar
P3/7-2E-15.3*	0.00 M.P.	0.05 M.P.	Barricade, drivable waterbar
P4/7-2E-14*	0.58 M.P.	0.79 M.P.	Barricade, drivable waterbar
7-2E-23.3*	0.00 M.P.	0.62 M.P.	Barricade, drivable waterbar

* No barricade needed if road rocked at Purchaser's expense.

3504 Stabilization work shall be completed at the end of timber hauling. All soil stabilization work shall be performed during the following seasonal periods to address soil moisture or as determined by the Authorized Officer:

From: May 1	To: November 30
-------------	-----------------

3506 Stockpiled slash shall be used to protect exposed areas created by the Purchaser's operations described in these sections. Slash shall be uniformly spread and placed without bunching. The operation shall produce a dense, uniform mat. Where slash is not available, exposed soil areas shall be stabilized in accordance with Section 1800.

3508 Protect areas mulched and treated with slash placement from damage by Purchaser traffic or construction equipment. Damaged areas shall be repaired by the Purchaser.

3509 Access shall be blocked with barricades as shown on the attached typical detail sheet and at locations flagged by the Authorized Officer.

3513 Water bars and drain dips shall be installed across full width of roadway as shown on the attached typical detail sheet and at locations flagged by the Authorized Officer.

3514 Protection of exposed surfaces shall be accomplished by placement of soil stabilization material in accordance with Section 1800 and placement of slash described in Subsection 3506 on designated roadways, disturbed areas, cut banks, fill slopes and other areas disturbed by the Purchaser's operations in accordance with these specifications and as shown in the plans.

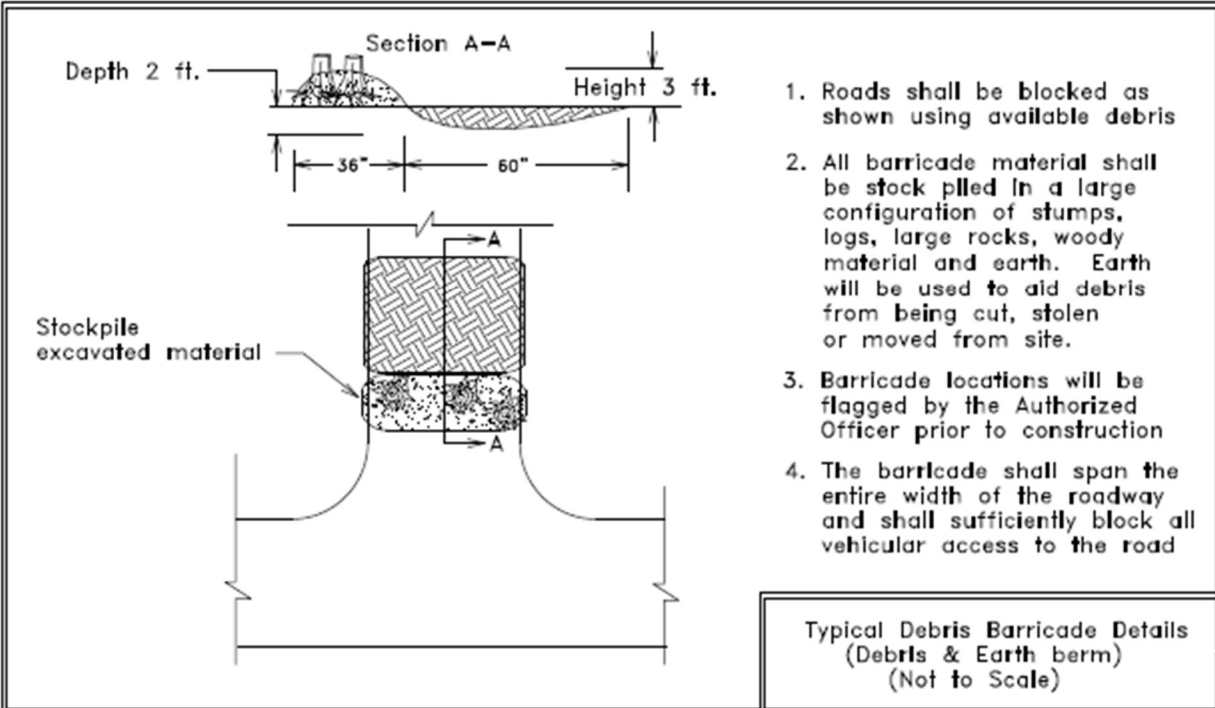

1. Roads shall be blocked as shown using available debris
2. All barricade material shall be stock piled in a large configuration of stumps, logs, large rocks, woody material and earth. Earth will be used to aid debris from being cut, stolen or moved from site.
3. Barricade locations will be flagged by the Authorized Officer prior to construction
4. The barricade shall span the entire width of the roadway and shall sufficiently block all vehicular access to the road

Typical Debris Barricade Details
 (Debris & Earth berm)
 (Not to Scale)

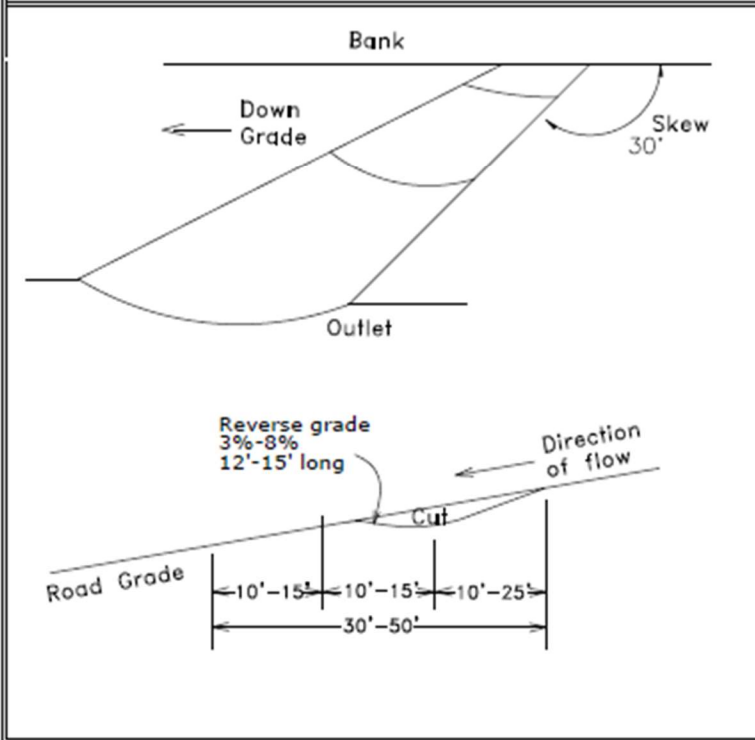

Typical Drainage Dip Details
 (Not to Scale)

1. Drain Dips shall be constructed to collect road surface run off and ditch water before reaching live stream.
2. Drain Dips shall extend from the cut bank to the fill slope and drain into vegetation with out any blockage.
3. Drain dips shall be skewed 30 degrees unless directed by the Authorized Officer.
4. Exact locations and quantities to be determined by the Authorized Officer.

1. Waterbars shall be constructed as shown.
2. Exact locations will be flagged by the Authorized Officer prior to construction.
3. All waterbars shall be skewed 30 degrees.
4. Waterbars shall extend from the cut bank to the fill slope and be readily crossed by passenger type vehicles.

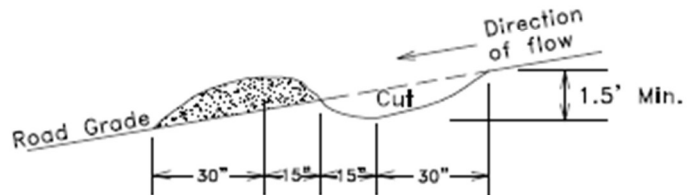

Typical NON-Drivable
 Waterbar Details
 (Not to scale)

Typical Drivable
 Waterbar Details
 (Not to scale)

1. Waterbars shall be constructed as shown.
2. Exact locations will be flagged by the Authorized Officer prior to construction.
3. All waterbars shall be skewed 30 degrees.
4. Waterbars shall extend from the cut bank to the fill slope and be readily crossed by passenger type vehicles.
5. The mound of material shall be compacted from the cut bank to the fill slope and shall be passable by passenger type vehicles.

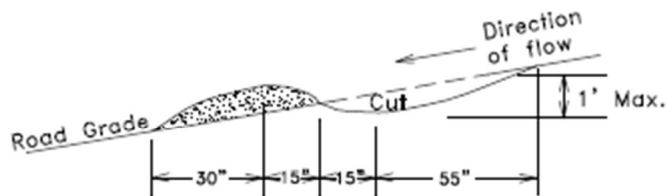

EXHIBIT I SPECIFICATIONS FOR SNAG CREATION

GENERAL:

1. Designated conifer trees (182) shall have tops removed (topping) by saw cutting, high girdling, or be base girdled as directed by the Authorized Officer.
2. One third (61) of the trees to be treated shall be high girdled. One third (60) of the trees to be treated shall be base girdled. One third (61) of the trees to be treated shall be Topped.
3. Topped, top girdled or girdled trees shall be well distributed within unit boundaries as directed by the Authorized Officer. Do not create snags within falling distance of power lines, structures or roads that will remain open after harvesting activities are complete.
4. The Purchaser shall furnish all labor, equipment, supervision, and supplies to perform all work.

HIGH GIRDLE:

1. Girdling height of live trees will vary by stand age and should range from 50-120 feet, or the top-third of the tree. Average girdling height is likely to be 80-110 feet in the 60-70 year old stands, and 60-80 feet in the 40-50 year old stands.
2. Trees High Girdled shall retain 15-25 live limbs that are at least 5 feet in length below the girdled site.
3. All cuts will completely sever the cambium, but not exceed ½ inch depth into the wood of the tree.
4. All cuts will be free of sawdust and debris.
5. High Girdled trees shall be marked with high visibility florescent orange flagging around the bole at a point ten to twenty feet above the ground so that it is readily visible from at least one hundred (100) feet away from the tree in all directions and two pieces of flagging tied to a branch, or bole, directly below the girdling site.

TOPPING:

1. Topping shall be done at a point within approximately 50 to 100 feet in height where the diameter of the main stem is between ten and fourteen (10-14) inches, or as directed by the Authorized Officer.
2. Remove live limbs 10 feet below the point where the tree is topped.
3. Treetops which are severed shall be completely severed from the tree and in such a manner that they are lying completely on the ground. No tops shall remain hung up in tops of other trees or leaning against the bole of any tree.
4. Severed tree tops which land on or immediately adjacent to a constructed fire trail, within a fuel reduction area, or in the right-of-way of a road or designated trail shall be moved as directed by the Authorized Officer the same day in which it was severed.
5. The top of the main stem of the tree shall be cut flat (no face cut notch or angled back cut).

6. The top of the main stem shall then have a vertical "V" notch cut at least six (6) inches down into the stem with the open end of the "V" approximately three (3) inches or 1/3 the diameter of the cut face in width, or be otherwise modified as directed by the Authorized Officer.
7. Florescent orange flagging shall be hung around the bole at a point ten to twenty feet above the ground so that it is readily visible from at least one hundred (100) feet away from the tree in all directions.

BASAL GIRDLE:

1. The bark and cambium layer shall be completely removed with a chainsaw or hand tools in a band at least twelve (12) inches wide completely around the main stem of the tree at a height between two (2) and eight (8) feet above the ground.
2. No more than one-half (1/2) inch of wood inside the cambium layer shall be cut.
3. Florescent orange flagging shall be hung around the bole at above where the tree was girdled so that it is readily visible from at least one hundred (100) feet away from the tree in all directions.

Legal Description of Contract Area

Land Status	County	Township	Range	Section	Subdivision	Meridian
O&C	Clackamas	7S	2E	15	NW¼, N½SW¼, SW¼SE¼	Willamette
O&C	Clackamas	7S	2E	23	N½SE¼	Willamette

Species Totals

Species	Net	Gross Merch	Gross	# of Merch Logs	# of Cull Logs	# of Trees
Douglas Fir	12,368.0	13,014.0	13,057.0	103,868	692	16,796
Bigleaf Maple	131.0	154.0	158.0	2,876	711	992
Red Alder	18.0	21.0	23.0	400	138	157
Totals	12,517.0	13,189.0	13,238.0	107,144	1,541	17,945

Cutting Area Acres

Regeneration Harvest Acres	Partial Cut Acres	Right of Way Acres	Total Acres	Net Volume per Acre
178.0	0.0	4.0	182.0	68.8

Logging Costs

Stump to Truck	\$1,274,685.47
Transportation	\$515,313.25
Road Construction	\$201,138.19
Maintenance/Rockwear	\$45,361.48
Road Use	\$37,551.00
Other Allowances	\$36,242.10
Total:	\$2,110,291.49
Total Logging Cost per MBF:	\$168.59

Utilization Centers

<u>Location</u>	<u>Distance</u>	<u>% of Net Volume</u>
Molalla	25.0 miles	99 %
Eugene	37.0 miles	1 %

Profit & Risk

Profit	10 %
Risk	2 %
Total Profit & Risk	12 %

Tract Features

Quadratic Mean DBH	21.7 in
Average GM Log	123 bf
Average Volume per Acre	68.8 mbf
Recovery	95 %
<u>Net MBF volume:</u>	
Green	12,517.0 mbf
Salvage	0 mbf
Export	0 mbf
<u>Ground Base Logging:</u>	
Percent of Sale Volume	46 %
Average Yarding Slope	20 %
Average Yarding Distance	400 ft
<u>Cable Logging:</u>	
Percent of Sale Volume	54 %
Average Yarding Slope	80 %
Average Yarding Distance	1200 ft
<u>Aerial Logging:</u>	
Percent of Sale Volume	0 %
Average Yarding Slope	0 %
Average Yarding Distance	0 ft

Cruise

Cruise Completed August 2019
Cruised By Rainey, M. Rainey, J. Poteet, J.
Cruise Method

The timber volumes for the Regeneration areas and Right-Of-Way volume were based on a variable plot cruise for estimating the board foot volume of trees. Plots were measured using a 40 basal factor.

Stumpage Computation

Species	# of Trees	Net Volume	Pond Value	(-) Profit & Risk	(-) Logging Costs	(+) Marginal Log Value	Appraised Price/MBF	Appraised Value
Douglas Fir	16,796	12,368.0	\$591.07	\$70.93	\$168.59	\$0.00	\$351.60	\$4,348,588.80
Bigleaf Maple	992	131.0	\$234.42	\$28.13	\$168.59	\$0.00	\$37.70	\$4,938.70
Red Alder	157	18.0	\$325.71	\$39.09	\$168.59	\$0.00	\$118.00	\$2,124.00
Totals	17,945	12,517.0						\$4,355,651.50

Percent of Volume By Log Grade

Species	No. 1 & 2 Peeler	No. 3 Peeler	Special Mill	No. 2 Sawmill	No. 3 Sawmill	No. 4 Sawmill	Camp Run
Douglas Fir			1.0 %	86.0 %	12.0 %	1.0 %	

Species	No. 1 Sawmill	No. 2 Sawmill	No. 3 Sawmill	No. 4 Sawmill	No. 5 Sawmill	Camp Run
Bigleaf Maple						100.0 %

Species	No. 1 Sawmill	No. 2 Sawmill	No. 3 Sawmill	No. 4 Sawmill	No. 5 Sawmill	Camp Run
Red Alder						100.0 %

Unit: 1

Species	Net	Gross Merch	Gross	# of Trees
Douglas Fir	7,112.0	7,496.0	7,532.0	9,045
Bigleaf Maple	112.0	133.0	137.0	855
Red Alder	8.0	10.0	10.0	58
Totals:	7,232.0	7,639.0	7,679.0	9,958

Net Volume/Acre: 72.3 MBF

Regeneration Harvest	100.0
Partial Cut	0.0
Right of Way	0.0
Total Acres:	100.0

Unit: 1 R/W

Species	Net	Gross Merch	Gross	# of Trees
Douglas Fir	284.0	300.0	302.0	362
Bigleaf Maple	5.0	5.0	5.0	34
Red Alder	1.0	1.0	1.0	2
Totals:	290.0	306.0	308.0	398

Net Volume/Acre: 72.5 MBF

Regeneration Harvest	0.0
Partial Cut	0.0
Right of Way	4.0
Total Acres:	4.0

Unit: 2

Species	Net	Gross Merch	Gross	# of Trees
Douglas Fir	853.0	900.0	905.0	1,085
Bigleaf Maple	14.0	16.0	16.0	103
Red Alder	1.0	1.0	1.0	7
Totals:	868.0	917.0	922.0	1,195

Net Volume/Acre: 72.3 MBF

Regeneration Harvest	12.0
Partial Cut	0.0
Right of Way	0.0
Total Acres:	12.0

Unit: 3

Species	Net	Gross Merch	Gross	# of Trees
Douglas Fir	4,119.0	4,318.0	4,318.0	6,304
Red Alder	8.0	9.0	11.0	90
Totals:	4,127.0	4,327.0	4,329.0	6,394

Net Volume/Acre: 62.5 MBF

Regeneration Harvest	66.0
Partial Cut	0.0
Right of Way	0.0
Total Acres:	66.0

Total Stump To Truck	Net Volume	\$/MBF
\$1,274,685.47	12,517.0	\$101.84

Stump to Truck: Falling, Bucking, Yarding, & Loading

Yarding System	Unit of Measure	# of Units of Measure	\$/Unit of Measure	Total Cost	Remarks
Cable: Large Yarder	GM MBF	6,571.0	\$113.28	\$744,362.88	7 Loads/Day
Track Skidder	GM MBF	305.0	\$94.17	\$28,721.85	R/W 6 Loads/Day
Feller Buncher	GM MBF	6,313.0	\$78.98	\$498,600.74	8 Loads/Day
Subtotal				\$1,271,685.47	

Additional Costs

Item	Unit of Measure	# of Units of Measure	\$/Unit of Measure	Total Cost	Remarks
Subtotal				\$0.00	

Additional Moves

Equipment	Unit of Measure	# of Units of Measure	\$/Unit of Measure	Total Cost	Remarks
Cable: Large Yarder	Each	1.0	\$750.00	\$750.00	Distance between units
Feller Buncher	Each	1.0	\$750.00	\$750.00	Distance between units
Shovel	Each	1.0	\$750.00	\$750.00	Distance between units
Stroke Delimber	Each	1.0	\$750.00	\$750.00	Distance between units
Subtotal				\$3,000.00	

Comments:

5mbf load/\$3.00 gallon

Total	Net Volume	\$/MBF
\$515,313.25	12,517.0	\$41.17

Utilization Center	One Way Mileage	Description	Unit of Measure	# of Units	\$/Unit of Measure	Total Cost	% of Sale Volume
Eugene	37.0	Haul	GM MBF	175.0	\$118.75	\$20,781.25	1 %
Molalla	25.0	Haul	GM MBF	13,014.0	\$38.00	\$494,532.00	99 %

Comments:

Hardwood to Eugene@ \$118.75 per thousand (\$95.00/HR. @ 4 MBF/Load); Fir to Molalla @ \$38 per thousand. Numbers generated per District C/A Miscellaneous Cost Sheet. (\$95.00/HR. @ 5 MBF/Load)

Engineering Allowances

Total	Net Volume	\$/MBF
\$284,050.67	12,517.0	\$22.69

Cost Item	Total Cost
Road Construction:	\$201,138.19
Road Maintenance/Rockwear:	\$45,361.48
Road Use Fees:	\$37,551.00

Comments:

Amortization fees to 3rd party \$37,551.00; Rockwear allowance \$19,751.95/Road maintenance allowance \$25,609.53 (Exhibit D); Road construction allowance (Exhibit C) \$201,138.19

Total	Net Volume	\$/MBF
\$36,242.10	12,517.0	\$2.90

Environmental Protection

Cost item	Total Cost
Basal Girdling	\$1,792.00
High Girdling	\$1,944.00
Saw Topping 34" and Below	\$3,825.00
Saw Topping 35" - 45"	\$3,750.00
Saw Topping 46" and Above	\$1,500.00
Equipment Washing	\$400.00
10% Administration Cost For Snag Creation	\$1,281.10
Subtotal	\$14,492.10

Slash Disposal & Site Prep

Cost item	Total Cost
Landing Pile Cover	\$525.00
Landing Pile Burn	\$525.00
Machine Pile Burn	\$3,450.00
Machine Pile Construction, Cover	\$17,250.00
Subtotal	\$21,750.00



UNITED STATES DEPARTMENT OF THE INTERIOR
 Bureau of Land Management
 Northwest Oregon District

Carolyn's Cranes
 Timber Sale
Appraisal Map
 Page 1 of 2

TIMBER SALE CONTRACT MAP - ORN01-TS-2021.0105
 T. 7 S. - R. 2 E., Section 15, W.M.

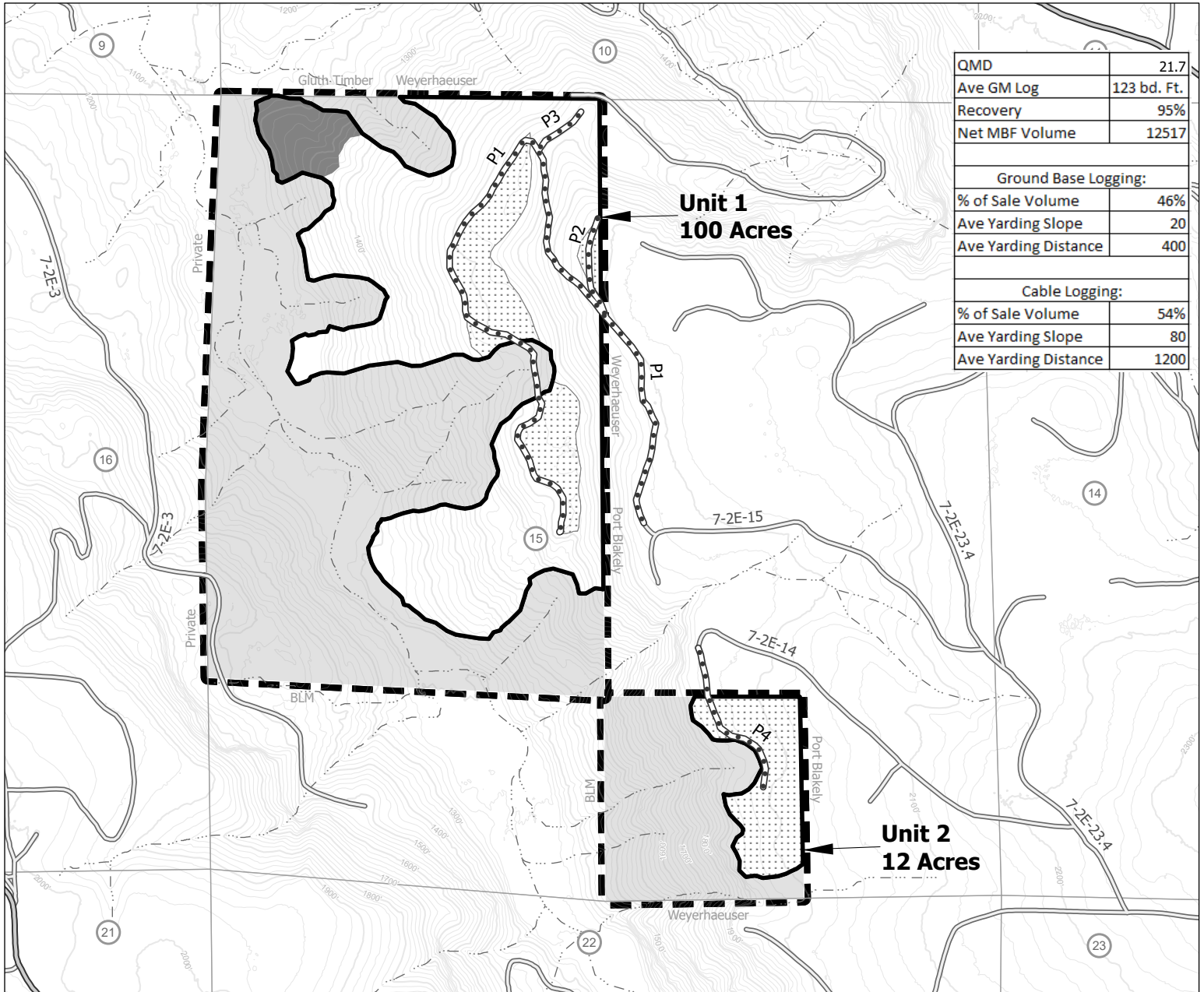

QMD	21.7
Ave GM Log	123 bd. Ft.
Recovery	95%
Net MBF Volume	12517
Ground Base Logging:	
% of Sale Volume	46%
Ave Yarding Slope	20
Ave Yarding Distance	400
Cable Logging:	
% of Sale Volume	54%
Ave Yarding Slope	80
Ave Yarding Distance	1200

Contour Interval: 20'

- Road to be Constructed
- Ground-Based Yarding
- County Road
- Skyline Yarding
- Existing Road
- Contract Area
- Reserve Area
- Stream
- Exhibit A Units

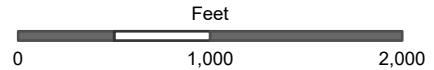

Regeneration Harvest Area	178.00 Acres
Leave Island	10.00 Acres
Road Right-of-Way	4.00 Acres
Reserve Area	164.26 Acres
Total Contract Area	356.26 Acres

Unit boundaries are painted orange and posted. Acres do not include existing or new roads. Acreage was calculated based on global positioning system traverse procedures including differential correction.



UNITED STATES DEPARTMENT OF THE INTERIOR
Bureau of Land Management
Northwest Oregon District

Carolyn's Cranes
Timber Sale
Appraisal Map
Page 2 of 2

TIMBER SALE CONTRACT MAP - ORN01-TS-2021.0105
T. 7 S. - R. 2 E., Section 23, W.M.

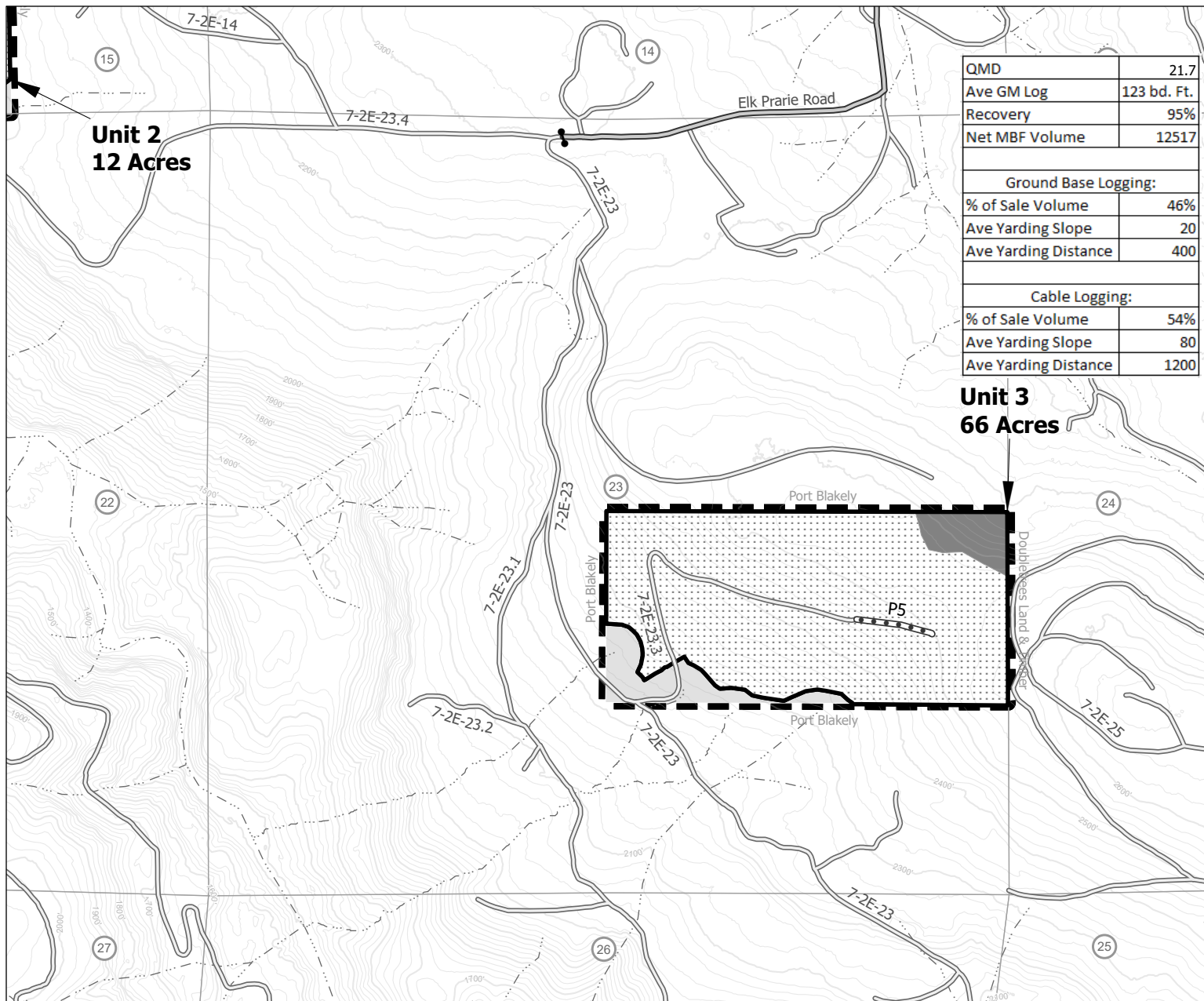

QMD	21.7
Ave GM Log	123 bd. Ft.
Recovery	95%
Net MBF Volume	12517
Ground Base Logging:	
% of Sale Volume	46%
Ave Yarding Slope	20
Ave Yarding Distance	400
Cable Logging:	
% of Sale Volume	54%
Ave Yarding Slope	80
Ave Yarding Distance	1200

Unit 3
66 Acres

Contour Interval: 20'

- Gate
- Road to be Constructed
- County Road
- Existing Road
- Stream
- Exhibit A Units
- Ground-Based Yarding
- Contract Area
- Reserve Area

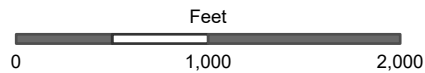

Regeneration Harvest Area	178.00 Acres
Leave Island	10.00 Acres
Road Right-of-Way	4.00 Acres
<u>Reserve Area</u>	<u>164.26 Acres</u>
Total Contract Area	356.26 Acres

Unit boundaries are painted orange and posted. Acres do not include existing or new roads. Acreage was calculated based on global positioning system traverse procedures including differential correction.



TIMBER SALE CONTRACT MAP - ORN01-TS-2021.0105

T. 7 S. - R. 2 E., Section 15, 23 W.M

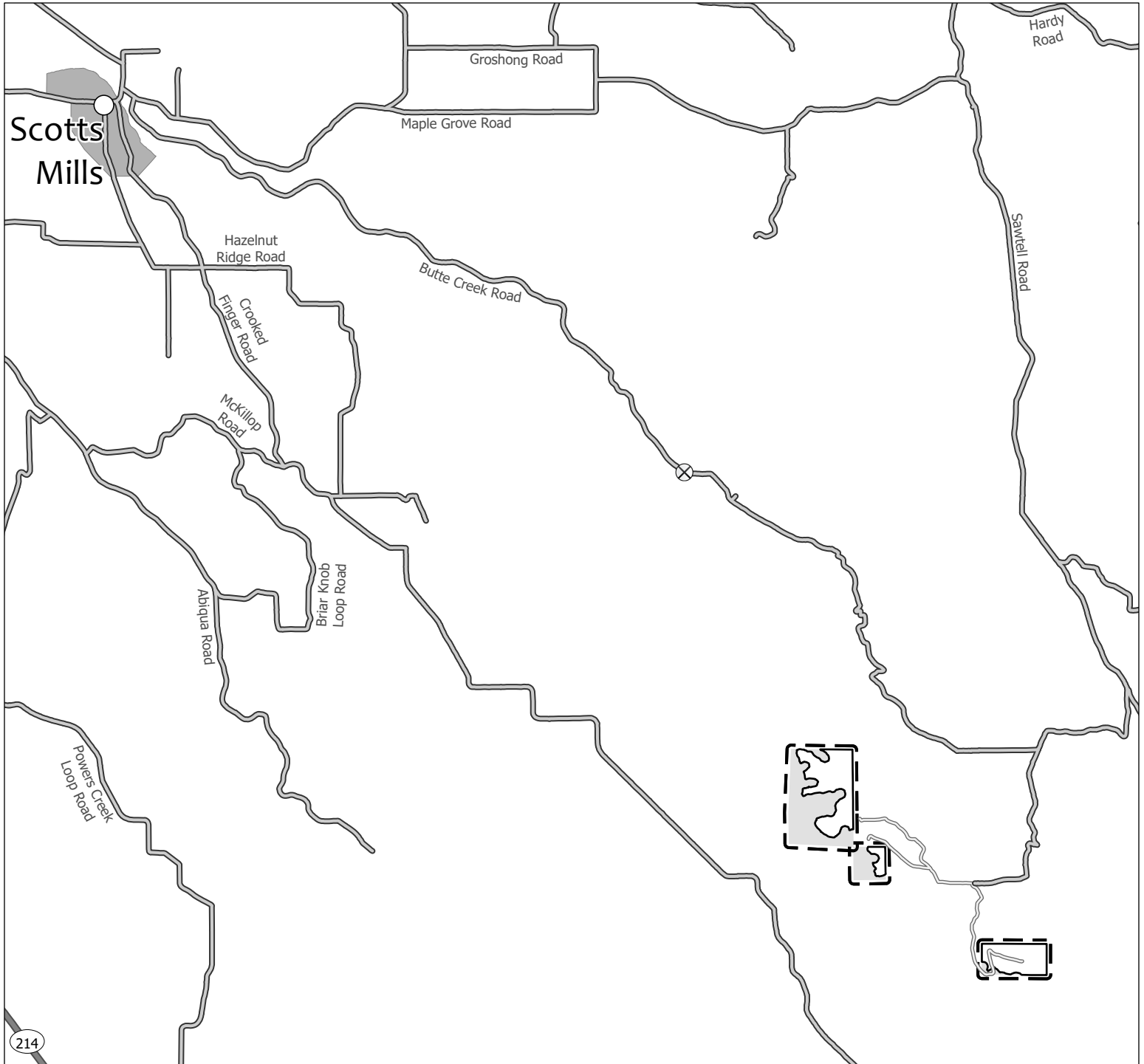

- ⊗ Road Blocked
- City, Town, or Community
- State Highway
- County Road
- Project Access Route
- City or Town
- Timbersale Units
- ▨ Reserve Area
- ⌞ Contract Area

