

UNITED STATES  
DEPARTMENT OF THE INTERIOR  
BUREAU OF LAND MANAGEMENT  
Northwest Oregon District Office  
1717 Fabry Road, S.E.  
Salem, Oregon 97306

ORN04-TS-2020.0402  
Fairchild Timber Sale

Date: August 14, 2020

PROSPECTUS

THIS IS A PROSPECTUS ONLY. ATTACHMENTS MAY NOT INCLUDE ALL EXHIBITS REFERRED TO IN THE CONTRACT. THE COMPLETE CONTRACT, INCLUDING ALL EXHIBITS, IS AVAILABLE FOR INSPECTION AT THE NORTHWEST OREGON DISTRICT OFFICE.

NOTICE IS HEREBY GIVEN that the Bureau of Land Management will offer for sale timber as described herein for sealed bid, pursuant to Instructions to Bidders, as stated on Form No. 5440-9. **Sealed bids will be received by the District Manager, or his representative, by appointment only at the Northwest Oregon District Office, 1717 Fabry Road, S.E., Salem, Oregon until 4:00 p.m., Tuesday, September 15, 2020. Please call 503-375-5653 to make an appointment. Appointments are available from 8am - 4pm, M-F.** Sealed bids will be opened at 9:00 a.m. on Wednesday, September 16, 2020. Due to pandemic restrictions the opening will be limited to BLM employees. All bidders will be notified via phone call after all bids have been opened and a high bidder declared.

A WRITTEN BID on Form 5440-9 at not less than the appraised price on a unit basis per species and the required minimum bid deposit shall be required to participate in sealed bidding.

TO QUALIFY FOR PARTICIPATION in a sealed bid sale, the bidder must submit a bid in a sealed envelope for each tract offered that includes:

- 1. Two copies of the bid written on Form 5440-9, Deposit and Bid For Timber/Vegetative Resources. No bid for less than the advertised appraised price on a unit basis per species and total price can be considered.**
- 2. The required minimum bid deposit specified in the timber sale notice for the tract.**
- 3. A properly executed Independent Price Determination Certificate, Form 5430-11. A certification that the bid was arrived at by the bidder or offeror independently, and was tendered without collusion with any other bidder or offeror.**
- 4. A completed Form 5450-17, Export Determination.**
- 5. The sealed envelope must be clearly marked that it is a "Bid for Timber" together with the sale name and number, the legal description time and date of sale and a contact name and phone number of the bidder.**

THIS TIMBER SALE NOTICE does not constitute the decision document for purposes of protest and appeal of a forest management decision. Consistent with 43 CFR Subpart 5003-Administrative Remedies, the notice of a timber sale, when published as a legal ad in a newspaper of general circulation shall constitute the decision document for purposes of protest and appeal. Protests may be filed with the Contracting Officer within 15 days of the publication of the aforementioned decision document in the newspaper. It is anticipated that the decision document will be published in the Yamhill Valley News Register on or about August 18, 2020. BLM does not warrant publication on this exact date. All parties considering protest of the timber sale decision document are encouraged to review the aforementioned newspaper(s) to ensure accurate knowledge of the exact publication date.

AN ENVIRONMENTAL ASSESSMENT was prepared for each timber sale tract, and a Finding of No Significant Impact has been documented. These documents are available for inspection as background for each timber sale tract at the Northwest Oregon District Office. The Tillamook tracts are available at the Tillamook Field Office.

THE VOLUMES LISTED herein are estimates only. The sale volumes listed are based on 16-foot taper breaks which must be taken into consideration if comparisons are made with volume predictions based on other standards. The volumes based on 32-foot taper breaks are shown for comparison purposes. No sale shall be made for less than the advertised appraised price. The Purchaser shall be liable for the total purchase price, without regard to the amount bid per unit, even though the quantity of timber actually cut or removed or designated for taking is more or less than the estimated volume or quantity so listed.

THIS TIMBER SALE has been cruised based upon Eastside Scribner board foot measure. The minimum bid figures shown by species are dollars per thousand board feet (MBF). The minimum bid increment will be \$0.10 per MBF.

A PERFORMANCE BOND in an amount not less than 20 percent of the total purchase price will be required for all contracts of \$2,500 or more. A minimum performance bond of not less than \$500 will be required for all installment contracts less than \$2,500.

QUALIFIED SMALL BUSINESS concerns may apply to SBA for a loan to provide financing for access road construction required under the terms of qualifying timber sale contracts, and necessary contract changes will be made. Approval of loan applications rests with SBA and may be contingent on availability of funds. Applicants for such loans shall notify BLM of their intention to apply for a loan.

PRE-AWARD QUALIFICATIONS. The high bidder may be required to furnish information to determine the ability to perform the obligations of the contract. If the high bidder is determined not qualified, responsible or refuses to respond within fifteen (15) days of a request for information pertaining to qualifications, the contract may be offered and awarded for the amount of the high bid to the highest of the bidders who is qualified, responsible, and willing to accept the contract.

LOG EXPORT AND SUBSTITUTION: All timber sales, including timber from Federal rights-of-ways, shall be subject to the restrictions relating to the export and substitution of unprocessed timber from the United States in accordance with P.L. 94-165 and 43 CFR 5400 and 5420, as amended.

LOG EXPORT AND SUBSTITUTION RESTRICTIONS: Excepting Port-Orford-cedar, all timber offered for sale hereunder is restricted from export from the United States in the form of unprocessed timber and is prohibited from being used as a substitute for exported private timber. The BLM has revised the log export restrictions special provision to reduce the log branding and painting requirements. The new requirements include branding of one end of all logs with a scaling diameter of over 10 inches. All loads of 11 logs or more, regardless of the diameter of the logs, will have a minimum of 10 logs branded on one end. All logs will be branded on loads of 10 logs or less. One end of all branded logs will be marked with yellow paint. At the discretion of the Contracting Officer, the Purchaser may be required to brand and paint all logs. The Purchaser shall bear any increased costs for log branding and painting.

CONTRACT TERMINATION: A revised Special Provision has been added to the contract which enables the Contracting Officer to suspend the contract to facilitate protection of certain plant or animal species, and/or to modify or terminate the contract when necessary to: (1) Comply with the Endangered Species Act or to prevent incidental take of northern spotted owls in accordance with management direction in the Record of Decision (ROD) and Resource Management Plan (RMP), or; (2) Comply with a court order, or; (3) Protect species which were identified for protection through survey and manage and/or protection buffer standards and guidelines or management direction established in the ROD and RMP.

ADDITIONAL INFORMATION concerning this timber sale tract is available at the above District Office. A copy of the timber sale contract is also available for inspection at the District Office. The prospectus for this/these sale(s) is also available online at: <https://www.blm.gov/programs/natural-resources/forests-and-woodlands/timber-sales>. The prospectus includes maps and tables that cannot be made Section 508 compliant. For help with its data or information, please contact the Northwest Oregon District Office at 503-375-5646.

Attachments:  
Form 5450-17  
Form 5430-11  
Form 5440-9

TIMBER SALE NOTICE

NORTHWEST OREGON DISTRICT  
TILLAMOOK FIELD OFFICE  
COLUMBIA MASTER UNIT

Sale Date: September 16, 2020

CONTRACT NO.: ORN04-TS-2020.0402, Fairchild Timber Sale, Lump Sum  
YAMHILL COUNTY, OREGON: O&C: SEALED BID:  
BID DEPOSIT REQUIRED: **\$167,600.00**

All timber designated for cutting on: S½NE¼, N½SE¼, **Sec. 10**; S½SW¼, S½SE¼, **Sec. 11**; W½NW¼, NW¼SW¼ **Sec. 13**; N½SW¼, N½SE¼, **Sec. 14**; T. 2 S., R. 6 W., WM., Oregon.

**THIS TIMBER SALE HAS BEEN CRUISED BASED UPON EASTSIDE SCRIBNER MEASURE.**

Minimum bid figures shown by species are dollars per thousand board feet (MBF). The minimum bid increment will be \$0.10 per MBF.

Approx. No. Merchantable Trees	Est. Vol. MBF 32' Log	Species	Est. Vol. MBF 16' Log	Appraised Price Per MBF	Estimated Volume Times Appraised Price
26,530	8,635.0	Douglas-fir	10,536.0	\$158.50	\$1,669,956.00
786	63.0	western hemlock	79.0	\$34.90	\$2,757.10
2,391	44.0	bigleaf maple	55.0	\$26.00	\$1,430.00
468	16.0	red alder	23.0	\$29.60	\$680.80
13	1.5	western redcedar	2.0	\$258.80	\$517.60
<b>30,188</b>	<b>8,759.5</b>	<b>Totals</b>	<b>10,695.0</b>		<b>\$1,675,341.50</b>

LOG EXPORT AND SUBSTITUTION RESTRICTIONS: All timber offered for sale hereunder is restricted from export from the United States in the form of unprocessed timber and also prohibited from substitution of exported private timber.

CRUISE INFORMATION: The timber volumes for the harvest units were based on a variable plot cruise for estimating the board foot volume of trees. Plots were measured using a 40 basal area factor (BAF) for all harvest units. None of the total sale volume is salvage material. For merchantable Douglas-fir trees the average DBHOB is 17.2 inches; the average gross merchantable log contains 76 bf (board feet); the total gross volume is approximately 11,190 MBF; and 95% recovery is expected.

CUTTING AREA: Four (4) units totaling approximately two hundred eighty (280) acres, of which sixty-five (65) acres shall be regeneration harvest and two hundred fifteen (215) acres shall be partial cut harvest. In addition, approximately three (3) acres of right-of-way shall be cut. Acres shown on Exhibit A have been computed using S1 mobile mapper and Trimble R1 GNSS receiver. Acreage was calculated based on Global Positioning System traverse procedures including differential correction.

DURATION OF CONTRACT: Contract length will be 36 months for cutting and removal of timber.

OPTIONAL CONTRIBUTION (Sec. 42.dd.): The Purchaser will have the option of performing Coarse Woody Debris or contributing forty-five thousand nine hundred thirty-five and 86/100 dollars (\$45,935.86) in lieu thereof. The option must be declared *prior* to contract execution.

LOCATION: The contract area is located approximately thirteen (13) air miles northwest of Yamhill, Oregon. Starting on Oregon Route 47, in Yamhill, head northwest on Pike Road for 5.1 miles. Pike Road becomes Turner Creek Rd. Continue following Turner Creek Rd for 6.5 miles. Veer left onto 2-6-11.0 for 0.3 miles where you will encounter Unit 1 of the Fairchild Timber Sale. Consult a project location map.

ACCESS AND ROAD MAINTENANCE:

Access is provided by County, Weyerhaeuser Company, and the Bureau of Land Management (BLM) controlled roads. All BLM controlled roads used in conjunction with this sale will be maintained by the Purchaser. Purchaser will be required to pay a rockwear obligation of nine thousand eight hundred eighty-eight and 20/100 dollars (\$9,888.20) to the Government and spread **640 CY** crushed rock on BLM roads for maintenance.

In the use of Weyerhaeuser Company controlled roads, under Right-of-Way Agreement No. S-805 (OR044601) and as shown on Exhibit E, the Purchaser will be required to enter into a license agreement which requires: (a) Purchaser maintenance of all Weyerhaeuser controlled roads, except the 2-5-10.0 (Seg. O16- M1, K4-K1, I3-I2, G4-E, C-A), 2-6-3.0 (A1-A3), 2-6-9.1 (A1-A7), and 2-6-12.1 (A, C-D4), (b) Purchaser pay a road use obligation fee of twenty one thousand three hundred ninety and 0/100 dollars (\$21,390.00), (c) Purchaser pay a rockwear fee of fifty three thousand thirty two and 38/100 dollars (\$53,032.38), (d) Purchaser shall pay a maintenance fee of sixty five thousand five hundred fourteen and 81/100 dollars (\$65,514.81), (e) Purchaser provide proof of insurance with limits of \$1,000,000/\$1,000,000/\$1,000,000 and a performance bond of \$10,000. Prior to the use of said roads, the Purchaser shall furnish the Authorized Officer a copy of the executed license agreement.

Road usage obligations and rockwear fees have been calculated using timber volumes based on the actual BLM timber sale cruise volume. Additional fees for road use obligation, maintenance, and rockwear will be calculated at the agreed upon rates (in the license agreement) for additional timber volume for non-BLM controlled roads. Additional fees for rockwear will be calculated at the current rate for additional timber volume for BLM controlled roads and be charged to the Purchaser. Purchaser maintenance shall include frequent blading and shaping or road surface; ditch, culvert, and catch basin cleaning; removal of minor slides and other debris. Roads shall be left in a condition to withstand adverse weather at the end of the seasonal operations. Purchaser shall also spread **255 CY** crushed rock on non-BLM roads as needed and instructed by the Authorized Officer.

ROAD CONSTRUCTION AND RENOVATION: The Purchaser will be required to do all work set forth below. The Purchaser shall supply all material unless otherwise indicated.

1. New Road Construction:

- Road 2-6-10.1: 1,763 feet, 14-foot ditched/crowned subgrade, Rock surfacing, Clearing and Grubbing, Construct turnout, turnarounds, ditchouts, and landing as marked, Spread/Place Spot & Bedding Rock as marked, Spread an 8" lift of 4"-0" Rock (Sta. 0+00 - 17+63), Spread a 4" lift of 1 ½"-0" Rock (Sta. 0+00 - 17+63), Install 5 Poly Pipes, Install 5 Metal "T" Posts as marked.
- Road 2-6-10.2: 162 feet, 14-foot outsloped subgrade, Rock surfacing, Clearing and Grubbing, Construct landing as marked, Spread/Place Spot Rock as marked, Spread an 8" lift of 4"-0" Rock (Sta. 0+00 - 1+62), Spread a 4" lift of 1 ½"-0" Rock (Sta. 0+00 - 1+62).
- Road 2-6-10.3: 438 feet, 14-foot ditched/crowned subgrade, Rock surfacing, Clearing and Grubbing, Construct ditchout and landing as marked, Spread/Place Spot & Bedding Rock as marked, Spread an 8" lift of 4"-0" Rock (Sta. 0+00 - 4+38), Spread a 4" lift of 1 ½"-0" Rock (Sta. 0+00 -

4+38), Place Rip-Rap for stabilization wall as marked, Install 1 Poly Pipe, Install 1 Metal “T” Post as marked.

Road 2-6-11.1: 433 feet, 14-foot ditched/crowned subgrade, Rock surfacing, Clearing and Grubbing, Construct turnaround and waste area as marked, Spread/Place Spot & Bedding Rock as marked, Spread an 8” lift of 4”-0” Rock (Sta. 0+00 – 4+33), Spread a 4” lift of 1 ½”-0” Rock (Sta. 0+00 – 4+33), Install 1 Poly Pipe with 1 lead-off ditch, Install 1 Metal “T” Post as marked.

Road 2-6-11.2: 273 feet, 14-foot ditched/crowned subgrade, Rock surfacing, Clearing and Grubbing, Construct turnaround and waste area as marked, Spread/Place Spot & Bedding Rock as marked, Spread an 8” lift of 4”-0” Rock (Sta. 0+00 – 2+73), Spread a 4” lift of 1 ½”-0” Rock (Sta. 0+00 – 2+73), Install 1 Poly Pipe.

Road 2-6-11.2: 176 feet, 14-foot outsloped subgrade, Rock surfacing, Clearing and Grubbing, Construct landing as marked, Spread/Place Spot Rock as marked, Spread an 8” lift of 4”-0” Rock (Sta. 2+73 – 4+49), Spread a 4” lift of 1 ½”-0” Rock (Sta. 2+73 – 4+49).

Road 2-6-11.3: 283 feet, 14-foot outsloped subgrade, Rock surfacing, Clearing and Grubbing, Construct turnaround and landing as marked, Spread/Place Spot Rock as marked, Spread an 8” lift of 4”-0” Rock (Sta. 0+00 – 2+83), Spread a 4” lift of 1 ½”-0” Rock (Sta. 0+00 – 2+83).

Road 2-6-14.2: 387 feet, 14-foot ditched/crowned subgrade, Rock surfacing, Clearing and Grubbing, Construct turnaround, ditchout, and landing as marked, Spread/Place Spot & Bedding Rock as marked, Spread an 8” lift of 4”-0” Rock (Sta. 17+80 – 21+67), Spread a 4” lift 1 ½”-0” Rock (Sta. 17+80 – 21+67), Install 1 Poly Pipe, Install 1 Metal “T” Post as marked.

Road 2-6-14.5: 150 feet, 14-foot outsloped subgrade, Rock surfacing, Clearing and Grubbing, Construct landing as marked, Spread/Place Spot Rock as marked, Spread an 8” lift of 4”-0” Rock (Sta. 0+00 – 1+50), Spread a 4” lift of 1 ½”-0” Rock (Sta. 0+00 – 1+50).

Road 2-6-14.6: 362 feet, 14-foot ditched/crowned subgrade, Rock surfacing, Clearing and Grubbing, Construct turnaround and landing as marked, Spread/Place Spot & Bedding Rock as marked, Spread an 8” lift of 4”-0” Rock (Sta. 0+00 – 3+62), Spread a 4” lift of 1 ½”-0” Rock (Sta. 0+00 – 3+62), Install 1 Poly Pipe.

Road 2-6-15.4: 788 feet, 14-foot ditched/crowned subgrade, Rocked surfacing, Clearing and Grubbing, Construct ditchout as marked, Remove existing slash pile (Sta. 0+43), Spread/Place Spot & Bedding Rock as marked, Spread an 8” lift of 4”-0” Rock (Sta. 0+00 – 7+88), Spread a 4” lift of 1 ½”-0” Rock (Sta. 0+00 – 7+88), Place Rip-Rap for stabilization wall/fill armor as marked, Install 1 Poly Pipe, Install 1 Metal “T” Post as marked.

## 2. Renovation:

Road 2-5-10.0 (Turner Creek Road): 7.647 miles, 16-foot ditched/crowned subgrade, Rocked surfacing, Blading and Compacting Surface, Clean Culverts, Clearing and Grubbing, Ditchline Re-establishment by bunching and hauling, Construct turnouts and ditchouts as marked, Excavate stream channel (MP 3.999) as marked, Spread/Place Spot, Bedding, & Pitrun Rock as marked, Place Rip-Rap for fill armor and energy dissipater as marked, Install 6 Poly Pipes, Replace 1 Poly Pipe and Replace 1 Metal Pipe, Install 55 Metal “T” Posts and Replace 1 Metal “T” Post as marked, Install 23 Sediment Catch Basins with Straw Bale as marked, and Place 70 SY of woven geosynthetic fabric as marked.

Road 2-5-29.1 (Fairchild Road): 2.375 miles, 14-foot ditched/crowned subgrade, Rocked surfacing, Blading and Compacting Surface, Clean Culverts, Brushing with some Clearing and Grubbing, Ditchline Re-establishment by bunching and hauling, Construct turnouts, turnarounds, waste areas, and ditchouts as marked, Spread/Place Spot, Bedding, & Pitrun Rock as marked, Spread a 6” lift of 1 ½”-0” Rock (MP 0.000 – 2.375), Place Rip-Rap for energy dissipater/fill armor and curve widening as marked, Install 4 Poly Pipes and Install 3 Poly Downspout Pipes,

- Replace 1 Poly Pipe, Install 33 Metal “T” Posts and Replace 1 Metal “T” Post as marked, and Install 14 Sediment Catch Basins with Straw Bale as marked.
- Road 2-6-3.0: 0.729 miles, 14-foot ditched/crowned subgrade, Rocked surfacing, Blading and Compacting Surface, Clean Culverts, Brushing with some Clearing and Grubbing, Ditchline Re-establishment by bunching and hauling, Construct turnout and ditchouts as marked, Spread/Place Spot Rock as marked, and Install 9 Metal “T” Posts as marked.
- Road 2-6-9.1: 0.855 miles, 14-foot ditched/crowned subgrade, Rocked surfacing, Blading and Compacting Surface, Clean Culverts, Brushing with some Clearing and Grubbing, Ditchline Re-establishment by bunching hauling, Construct turnout, ditchouts, and waste area as marked, Spread/Place Spot, Bedding, & Pitrun Rock as marked, Spread a 6” lift of 1 ½”-0” Rock (MP 0.646 – 0.847), Place Rip-Rap for fill armor and energy dissipater as marked, Install 3 Poly Pipes and Replace 1 Poly Pipe, Install 1 Poly Downspout Pipe and Repair 1 Metal Downspout Pipe, Install 12 Metal “T” Posts and Replace 1 Metal “T” Post as marked, and Install 4 Sediment Catch Basins with Straw Bales as marked.
- Road 2-6-9.1: 0.017 miles, 14-foot outsloped subgrade, Rocked surfacing, Blading and Compacting Surface, Brushing with some Clearing and Grubbing, Spread/Place Spot & Bedding Rock as marked, Install 1 Poly Pipe and Replace 1 Poly Pipe with salvaged pipe as marked, and Install 2 Metal “T” Posts as marked.
- Road 2-6-11.0: 4,413 feet, 14-foot ditched/crowned subgrade, Rocked surfacing, Blading and Compacting Surface, Brushing with some Clearing and Grubbing, Ditchline Re-establishment by bunching and hauling, Construct turnouts, turnarounds, ditchouts, and waste area as marked, Spread/Place Spot & Bedding Rock as marked, Spread a 6” lift of 4”-0” Rock (Sta. 0+00 – 15+43), Spread an 8” lift of 4”-0” Rock (Sta. 15+43 – 44+13), Spread a 4” lift of 1 ½”-0” Rock (Sta. 0+00 – 44+13), Install 3 Poly Pipes, and Install 3 Metal “T” Posts as marked.
- Road 2-6-11.1: 3,847 feet, 14-foot ditched/crowned subgrade, Rocked surfacing, Blading and Compacting Surface, Clearing and Grubbing, Ditchline Re-establishment by bunching and hauling, Construct turnouts, turnarounds, ditchouts, waste areas, and landing as marked, Spread/Place Spot & Bedding Rock as marked, Spread an 8” lift of 4”-0” Rock (Sta. 4+33 – 42+80), Spread a 4” lift of 1 ½”-0” Rock (Sta. 4+33 – 42+80), Place Rip-Rap for fill armor/stabilization wall and energy dissipater as marked, Install 1 Free Draining Fill with 1 ½”-3/4” Drain Rock with 200 SY of non-woven geosynthetic fabric as marked, Install 11 Poly Pipes and Replace 1 Poly Pipe, Install 2 Poly Downspout Pipes, Install 12 Metal “T” Posts as marked, and Install 4 Sediment Catch Basins with Straw Bales as marked.
- Road 2-6-12.1: 0.710 miles, 14-foot ditched/crowned subgrade, Rocked surfacing, Blading and Compacting Surface, Brushing with some Clearing and Grubbing, Ditchline Re-establishment by bunching and hauling, Construct turnouts, ditchouts, and lead-off ditch as marked, Spread/Place Spot & Bedding Rock as marked, Install 2 Poly Pipes and Replace 1 Poly Pipe, and Install 5 Metal “T” Posts as marked.
- Road 2-6-14.0: 2,275 feet, 14-foot ditched/crowned subgrade, Rocked surfacing, Blading and Compacting Surface, Brushing with some Clearing and Grubbing, Ditchline Re-establishment by bunching and hauling, Construct turnout as marked, Spread/Place Spot & Bedding Rock as marked, Install 2 Poly Pipes and Install 1 Poly Downspout Pipe, and Install 4 Metal “T” Posts as marked.
- Road 2-6-14.2: 1,780 feet, 14-foot ditched/crowned subgrade, Rocked surfacing, Blading and Compacting Surface, Brushing with some Clearing and Grubbing, Ditchline Re-establishment by bunching and hauling, Construct turnout, turnaround, waste area, and ditchouts as marked, Spread/Place Spot & Pitrun Rock as marked, Spread a 6” lift of 4”-0” Rock (Sta. 0+00 – 17+80), Spread a 4” lift of 1 ½”-0” Rock (Sta. 0+00 – 17+80), and Install 1 Metal “T” Post as marked.

Road 2-6-14.3: 1,216 feet, 14-foot ditched/crowned subgrade, Rocked surfacing, Blading and Compacting Surface, Brushing with some Clearing and Grubbing, Ditchline Re-establishment by bunching and hauling, Construct turnout, turnaround, lead-off ditch, and landing as marked, Spread/Place Spot & Bedding, Rock as marked, Spread an 8" lift of 4"-0" Rock (Sta. 0+00 – 12+16), Spread a 4" lift of 1 ½"-0" Rock (Sta. 0+00 – 12+16), Install 5 Poly Pipes and 1 Poly Downspout Pipe, and Install 4 Metal "T" Posts as marked.

Road 2-6-14.4: 1,064 feet, 14-foot ditched/crowned subgrade, Rocked surfacing, Blading and Compacting Surface, Brushing with some Clearing and Grubbing, Ditchline Re-establishment by bunching and hauling, Construct turnouts, ditchout, and landings as marked, Spread/Place Spot Rock as marked, Spread an 8" lift of 4"-0" Rock (Sta. 0+00 – 10+64), Spread a 4" lift of 1 ½"-0" Rock (Sta. 0+00 – 10+64), and Install 2 Metal "T" Posts as marked.

Road 2-6-15.4: 1,370 feet, 14-foot ditched/crowned subgrade, Rocked surfacing, Blading and Compacting Surface, Clearing and Grubbing, Ditchline Re-establishment by bunching and hauling, Construct turnarounds, ditchouts, and landing as marked, Spread/Place Spot & Bedding Rock, Spread an 8" lift of 4"-0" Rock (Sta. 9+81 – 23+51), Spread a 4" lift of 1 ½"-0" Rock (Sta. 9+81 – 23+51), and Install 1 Poly Pipe and 1 Poly Downspout Pipe.

3. Improvement:

Road 2-6-11.0: 166 feet, 14-foot ditched/crowned subgrade, Rocked surfacing, Blading and Compacting Surface, Clearing and Grubbing, Ditchline Re-establishment by bunching and hauling, Construct landing as marked, Spread/Place Spot & Bedding Rock as marked, Spread an 8" lift of 4"-0" Rock (Sta. 44+13 – 45+79), Spread a 4" lift of 1 ½"-0" Rock (Sta. 44+13 – 45+79), and Install 1 Poly Pipe.

Road 2-6-14.1: 206 feet, 14-foot ditched/crowned subgrade, Rocked surfacing, Blading and Compacting Surface, Brushing with some Clearing and Grubbing, Ditchline Re-establishment by bunching and hauling, Spread/Place Spot Rock as marked, Spread an 8" lift of 4"-0" Rock (Sta. 0+00 – 2+06), and Spread a 4" lift of 1 ½"-0" Rock (Sta. 0+00 – 2+06).

Road 2-6-15.4: 193 feet, 14-foot ditched/crowned subgrade, Rocked surfacing, Blading and Compacting Surface, Brushing with some clearing and Grubbing, Ditchline Re-establishment by bunching and hauling, Spread an 8" lift of 4"-0" Rock (Sta. 7+88 -9+81), and Spread a 4" lift of 1 ½"-0" Rock (Sta. 7+88 – 9+81).

4. Estimated Quantities:

a. Clearing, Grubbing, and Brushing:

10.30 acres of Clearing and Grubbing

6.60 miles of Brushing

b. Culverts:

1,995 feet of 18 inch Corrugated Plastic Pipe (CPP) – Type S (48 Pipes)

90 feet of 18 inch Corrugated Plastic Pipe (CPP) – Type C (9 Pipes)

185 feet of 24 inch Corrugated Plastic Pipe (CPP) – Type S (4 Pipes)

140 feet of 36 inch Corrugated Plastic Pipe (CPP) – Type S (2 Pipes)

30 feet of 42 inch 14 gauge Aluminized Steel Pipe (CMP) – (1 Pipe)

152 Metal "T" Posts for Inlet Marker

18 Metal "T" Posts for Attaching Downspouts

c. Aggregate & Asphalt Material:

Quantity

Description

11,995 cubic yards	1 ½” minus crushed rock – Construction Rock
11,447 cubic yards	4” minus crushed rock – Construction Rock
1,070 cubic yards	1 ½” minus crushed rock – Culvert Bedding Material
150 cubic yards	1 ½” – ¾” crushed rock – Drain Rock
925 cubic yards	1 ½” minus crushed rock- BLM Maintenance Rock
465 cubic yards	1 ½” minus crushed rock – Non-BLM Maintenance Rock
1,470 cubic yards	Rip-Rap – (Class 3)

Rock Source: All 1 ½”-0”, 4”-0”, and Drain Rock – Commercial Source  
All Rip-Rap (Class 3) – Commercial Source

Other:

Compaction of all final grades will be required.

Right of way debris will be disposed of by scattering adjacent to all roads, outside of clearing limits.

All roads shall be left open.

Grass seeding will be required on all newly disturbed areas. Grass seed will be furnished by the Government.

Straw mulch will be required on all disturbed/seeded soils that are wet and/or within 50 feet each side of “Live stream” locations and all disposal sites. Grass straw will be furnished by the Government.

All waste from re-establishing ditchlines on rock surfaced roads shall be bunched and end-hauled to designated waste area.

All culverts removed shall be salvaged and delivered to the BLM Maintenance Facility at the SW ¼ of Section 5, T. 3 S., R. 6 W., W.M.

SEASONAL RESTRICTION MATRIX:

**Restricted Times are Shaded**

Activity	JAN		FEB		MAR		APR		MAY		JUN		JUL		AUG		SEP		OCT		NOV		DEC		
	1	16	1	16	1	16	1	16	1	16	1	16	1	16	1	16	1	16	1	16	1	16	1	16	
<b>Mechanized falling and Ground-Based yarding</b>																									
<b>Cable yarding, log haul, and rock haul</b> from Roads 2-5-10.0, 2-5-29.1, 2-6-3.0, 2-6-9.1, 2-6-10.1, 2-6-10.2, 2-6-10.3, 2-6-11.0, 2-6-11.1, 2-6-11.2, 2-6-11.3, 2-6-12.1, 2-6-14.0, 2-6-14.1, 2-6-14.2, 2-6-14.3, 2-6-14.4, 2-6-14.5, 2-6-14.6, and 2-6-15.4																									
<b>Maintenance activities, roadside brushing and rock crushing</b>																									
<b>Road renovation, construction, improvement</b>																									
<b>In-Stream Activities</b> in the North Yamhill River watershed																									
<b>In-Stream Activities</b> in the Trask River watershed																									



## TIMBER SALE CONTRACT SPECIAL PROVISIONS

### Sec. 41. Timber and Area Reservation Provisions

#### RESERVED

- a. All timber in the reserve and clump areas shown on Exhibit A, and all trees that are painted orange and posted, which mark the boundaries of the timber sale units.
- b. All trees marked with orange paint above and below stump height within the boundaries of the timber sale units shown on Exhibit A.
- c. All conifer trees less than seven (7) inches diameter at breast height (dbh), all Pacific madrone, all Pacific dogwood, all Oregon ash, and all Oregon white oak in the Sale Areas shown on Exhibit A which do not present a safety hazard as determined by the Authorized Officer. If any are felled, they shall be retained on site.
- d. Existing down logs and snags in the Sale Area, as shown on Exhibit A, which do not present a safety hazard as determined by the Authorized Officer. All snags felled shall be retained on site.
- e. Trees felled within road rights-of-way, which are marked with yellow paint above and below stump height shall remain on site and be placed outside of the road prism.

### Sec. 42. Special Provisions

#### LOGGING

- a. Before beginning operations on the Contract Area for the first time or after a shutdown of seven (7) or more days, the Purchaser shall notify the Authorized Officer in writing of the date they plan to begin operations. This written notification must be received by the Authorized Officer no less than seven (7) days prior to the date the Purchaser plans to begin or resume operations. The Purchaser shall also notify the Authorized Officer in writing if they intend to cease operations for any period of seven (7) or more days.
- b. Prior to the commencement of operations, the Purchaser shall obtain from the Authorized Officer approval of a written operations and logging plan commensurate with the terms and conditions of the contract which shall include measures needed to assure protection of the environment and watershed. A pre-work conference between the Purchaser's authorized representative and the Authorized Officer must be held before the logging plan will be approved. All logging shall be done in accordance with the approved logging plan. The Purchaser shall provide a minimum of seven (7) days notice when requesting the scheduling of a pre-work conference.
- c. Excessive damage to reserve timber, as determined by the Authorized Officer, will result in suspension of yarding operations until corrective measures to prevent further damages have been approved by the Authorized Officer.

d. No falling, yarding, or loading is permitted in or through the reserve areas, shown on Exhibit A, unless otherwise approved by the Authorized Officer.

e. Prior to attaching any logging equipment to a reserve tree, the Purchaser shall obtain approval from the Authorized Officer, and shall take precautions to protect the tree from damage as directed by the Authorized Officer.

f. At all landings, all non-merchantable logs more than eight (8) inches in diameter at the large end and exceeding eight (8) feet in length shall be scattered, or decked at a location designated by the Authorized Officer.

g. In skyline harvest areas all yarding shall be done with a skyline or similar cable system equipped with a slack pulling carriage capable of yarding two thousand four hundred (2,400) feet slope distance from the landing and at least seventy-five (75) feet laterally from the skyline to the designated sky road. The carriage shall be capable of being held in position on the skyline during all lateral yarding and shall be able to pass intermediate support jacks as required. The leading end of all logs shall be transported free of the ground during yarding. Full suspension is required within fifty (50) feet of streams. The rigging of tail or lift trees, intermediate supports and use of tail holds outside the Sale Areas shall be required where necessary to meet this requirement. Space designated skyline corridors at a minimum of one hundred fifty (150) feet apart unless otherwise agreed to in writing by the Authorized Officer.

h. Ground-based operations are limited to slopes of thirty-five (35) percent or less. The Authorized Officer may approve the use of specialized, ground-based, mechanized equipment (machines specifically designed to operate on slopes greater than 35%) on slopes of 50% or less, except within two hundred ten (210) feet of streams. All skidding shall be done by equipment operated entirely on skid trails that have been approved by the Authorized Officer and use existing skid trails where available. The area composed of skid trails shall not exceed fifteen (15) percent of the total yarding area within a unit. Excavation on designated skid trails shall be limited to a maximum cut of one (1) foot unless otherwise approved by the Authorized Officer. The Purchaser shall directionally fall trees into the lead with the skidding direction and winch or carry the logs to the skid trails. Temporary logging roads, skid trails, and harvester/forwarder trails would be water barred and blocked as directed by the Authorized Officer, after each operating season before the fall wet season begins.

i. Before cutting and removing any trees necessary to facilitate logging in the Sale Areas shown on Exhibit A, the Purchaser shall identify the location of skid trails, cable yarding roads, and tail hold, tieback, guy line, lift, intermediate support, and danger trees on the ground in a manner approved by the Authorized Officer at the pre-work conference, and documented in the Logging Plan. Said Purchaser identification of trees to be cut and removed does not constitute authority to proceed with cutting and removal. In addition, before proceeding the following conditions must be met:

1. All skid trails and/or cable yarding roads upon which timber is identified by the Purchaser to be cut and removed in accordance with this special provision must be necessary for the safe and expeditious removal of timber sold under this contact and shall be limited to the minimum width necessary for yarding of logs with a minimum of damage to reserve trees.

2. The Purchaser may immediately cut and remove additional timber to clear skid trails and cable yarding roads; and provide tail hold, tieback, guy line, lift and intermediate support

trees when the trees have been marked with blue or green paint above and below stump height by the Authorized Officer and thereby approved for cutting and removal by the Authorized Officer. When trees are marked with yellow paint above and below stump height they may be cut, but must remain on site. The volume of the timber to be sold will be determined by the Authorized Officer in accordance with Bureau of Land Management prescribed procedures. No timber may be cut or removed under terms of this provision unless sufficient installment payments have been made in accordance with Sec. 3.(b). of the contract or sufficient bonding has been provided in accordance with Sec. 3.(d). of the contract.

3. The Purchaser agrees that sale of this additional timber shall be accomplished by a unilateral modification of the contract executed by the Contracting Officer and that such timber shall be sold at the unit prices shown in Exhibit B of this contract unless: the value of the timber must be reappraised subject to the terms for contract extension set forth in Sec. 9. of the contract; or, the Authorized Officer determines that the tree species are not listed in Exhibit B of this contract and otherwise reserved in Sec. 41. of the contract or any tree that exceeds forty (40) inches dbh shall be appraised and sold by bilateral modification of the contract at current fair market value in accordance with Sec. 8. of the contract.

4. This authorization for the Purchaser to cut and remove additional timber prior to the execution of a modification may be withdrawn by the Contracting Officer if the Authorized Officer determines that the Purchaser has cut and removed any tree not previously marked and approved for cutting by the Authorized Officer, which under Sec. 10. of the contract constitutes a violation of the contract and under Sec. 13. of the contract may constitute a trespass rendering the Purchaser liable for damages under applicable law.

5. If authorization is withdrawn, the Contracting Officer shall issue a written notice to the Purchaser that the sale of additional timber under this special provision is no longer approved. In this case, the Purchaser shall inform the Authorized Officer at least one (1) working day prior to the need for cutting and removing any additional timber, and execute a bilateral modification prior to cutting for such additional approved timber at the unit prices shown in Exhibit B of the contract or in accordance with Sec. 8. or Sec. 9. of the contract as determined by the Authorized Officer in accordance with this provision. The Contracting Officer may issue a written order to the Purchaser to suspend, delay, or interrupt any or all contract work for the period of time deemed necessary and appropriate for the Government to safely measure and mark additional timber.

#### SAFETY

j. Purchaser's operations shall facilitate BLM's safe and practical inspection of Purchaser's operations and BLM's conduct of other official duties on Contract Area. Purchaser has all responsibility for compliance with safety requirements for Purchaser's employees, contractors and subcontractors.

In the event that the Authorized Officer identifies a conflict between the requirements of this contract or agreed upon methods of proceeding hereunder and State or Federal safety requirements, the contract may be modified. If the cost of such contract modification is of a substantial nature (\$2,000.00 or more), the Purchaser may request, in writing, an adjustment in the Total Purchase Price specified in Sec. 2. of the timber sale contract, as amended, to compensate for the changed conditions.

Unless otherwise specified in writing, when operations are in progress adjacent to or on roads and/or trails in the harvest unit area, Purchaser shall furnish, install, and maintain all temporary traffic controls that provide the road or trail user with adequate warning of and protection from hazardous or potentially hazardous conditions associated with its operations. Purchaser shall prepare a Traffic Control Plan, which the Purchaser has determined is compliant with state and local OSHA and Transportation standards no later than the pre-work meeting and prior to commencing operations. Traffic control devices shall be appropriate to current operating and/or weather conditions and shall be covered or removed when not needed. Flagmen and devices shall be as specified in state OSHA and Transportation standards for logging roads or the “Manual on Uniform Traffic Control Devices for Streets and Highways” (MUTCD) published by the U.S. Department of Transportation - Federal Highway Administration. Included in the Traffic Control Plan, Purchaser shall note traffic control device locations on a Purchaser-produced copy of the contract Exhibit A Map.

### SEASONAL RESTRICTIONS

k. No mechanized falling or ground based equipment operation within harvest units shown on Exhibit A during wet season (generally between October 16 of one calendar year and May 31 of the following calendar year) and during periods of wet soil conditions as determined by Authorized Officer.

l. No road renovation, road construction, road improvement, or road decommissioning (except roadside brushing, which is permitted year round), shown on Exhibit C, shall be conducted during the wet season, generally between October 16 of one calendar year and May 31 of the following calendar year, or during periods of wet soil conditions during the dry season as determined by Authorized Officer.

m. No road maintenance, as shown on Exhibit E, and described in Exhibit D, shall be conducted during periods of wet soil conditions as determined by the Authorized Officer.

n. No work required in live streams shall be conducted between October 1 of one calendar year and July 14 of the following calendar year in the North Yamhill River watershed, both days inclusive, and between September 16 of one calendar year and June 30 of the following calendar year in the Trask River watershed, both days inclusive, unless BLM receives a waiver from the Oregon Department of Fish and Wildlife, and is approved by the Authorized Officer.

### ROAD CONSTRUCTION, RENOVATION, IMPROVEMENT, MAINTENANCE AND USE

o. The Purchaser shall construct surfaced roads: 2-6-10.1, 2-6-10.2, 2-6-10.3, 2-6-11.1 (Sta. 0+00 – 4+33), 2-6-11.2, 2-6-11.3, 2-6-14.2 (Sta. 17+80 – 21+67), 2-6-14.5, 2-6-14.6, and 2-6-15.4 (Sta. 0+00 – 7+88). The Purchaser shall renovate surfaced roads: 2-5-10.0, 2-5-29.1, 2-6-3.0, 2-6-9.1, 2-6-11.0 (Sta. 0+00 – 44+13), 2-6-11.1 (Sta. 4+33 – 42+80), 2-6-12.1, 2-6-14.0, 2-6-14.2 (Sta. 0+00 – 17+80), 2-6-14.3, 2-6-14.4, and 2-6-15.4 (Sta. 9+81 – 23+51). The Purchaser shall improve surfaced roads: 2-6-11.0 (Sta. 44+13 – 45+79), 2-6-14.1, and 2-6-15.4 (Sta. 7+88 – 9+81). Construction, renovation, and improvement shall be done in strict accordance with the plans and specifications shown on Exhibit C, which is attached hereto and made a part hereof.

p. Any required construction, renovation, and improvement shall be completed and accepted prior to the removal of any timber, except right-of-way timber, over the road.

q. The Purchaser is authorized to use the roads listed below and shown on Exhibit E which are under the jurisdiction of the Bureau of Land Management for the removal of Government timber sold under the terms of this contract and/or the hauling of rock as required in Exhibit C provided the Purchaser complies with the condition set forth in Sec. 42.r.

Road No. and Segment	Length Miles Used	Road Control	Road Surface Type	Maintenance Responsibility
2-5-10.0 (Seg. L, J2-J1, H2-H1, D)	0.558	BLM	Rocked	Purchaser
2-5-29.1 (Seg. P, R, T1-T2, V1-V3)	1.430	BLM	Rocked	Purchaser
2-6-9.1 (Seg. B1-B2)	0.080	BLM	Rocked	Purchaser
2-6-10.1	0.334	BLM	Rocked	Purchaser
2-6-10.2	0.031	BLM	Rocked	Purchaser
2-6-10.3	0.083	BLM	Rocked	Purchaser
2-6-11.0 (Seg. B1-B3)	0.559	BLM	Rocked	Purchaser
2-6-11.1 (Seg. A1-A2, C)	0.565	BLM	Rocked	Purchaser
2-6-11.2	0.085	BLM	Rocked	Purchaser
2-6-11.3	0.054	BLM	Rocked	Purchaser
2-6-12.1 (Seg. B1-B3)	0.219	BLM	Rocked	Purchaser
2-6-14.2 (Seg. A1-A2, B4, C)	0.177	BLM	Rocked	Purchaser
2-6-14.3	0.230	BLM	Rocked	Purchaser
2-6-14.4	0.202	BLM	Rocked	Purchaser
2-6-14.5	0.028	BLM	Rocked	Purchaser
2-6-14.6	0.069	BLM	Rocked	Purchaser
2-6-15.4 (Seg. D1-G2)	0.445	BLM	Rocked	Purchaser

r. The Purchaser shall perform any road repair and maintenance work on roads used, under the terms of Exhibit D, "Road Maintenance Specifications" of this contract which is attached hereto and made a part hereof. Purchaser shall spread **640** cubic yards of crushed rock on BLM controlled roads as directed by the Authorized Officer and as part of maintenance requirements. Purchaser shall also pay a rockwear fee of \$9,888.20 to the Government. Additional fees for rockwear will be calculated at the current rate for additional timber volume for BLM controlled roads and be charged to the Purchaser, and be paid prior to contract termination.

s. In the use of roads listed below and shown on Exhibit E, the Purchaser shall comply with the conditions of Right-of-Way and Road Use Agreement S-805 (OR044601) between the United States of America and Weyerhaeuser Company. The Purchaser will be required to enter into a license agreement with Weyerhaeuser Company prior to commencement of operations. The Purchaser shall furnish to the Authorized Officer a copy of the required executed license agreement. The license agreement conditions include:

1) Purchaser pay a road use obligation fee to Weyerhaeuser Company of twenty one thousand three hundred ninety and 0/100 (\$21,390.00) dollars. Road use fees have been calculated using the actual BLM timber sale cruise volume. Additional fees for road use obligations will be calculated at the agreed upon rates (in the license agreement) for additional timber volume for non-BLM controlled roads.

2) Purchaser pay a rockwear fee to Weyerhaeuser Company of fifty three thousand thirty two and 38/100 (\$53,032.38) dollars. Rockwear fees have been calculated using the actual BLM timber sale cruise volume. Additional fees for rockwear will be calculated at the agreed upon rates (in the license agreement) for additional timber volume for non-BLM controlled roads.

3) The Purchaser shall *not* perform maintenance on road 2-5-10.0 (Seg. O16- M1, K4-K1, I3-I2, G4-E, C-A), 2-6-3.0 (A1-A3), 2-6-9.1 (A1-A7), and 2-6-12.1 (A, C-D4). Purchaser shall pay a maintenance fee to Weyerhaeuser Company of sixty five thousand five hundred fourteen and 81/100 (\$65,514.81) dollars. Maintenance fees have been calculated using the actual BLM timber sale cruise volume. Additional fees for maintenance will be calculated at the agreed upon rates (in the license agreement) for additional timber volume on non-BLM roads.

4) The Purchaser shall perform any road repair and maintenance work on road 2-5-29.1 (Seg. O, Q, S1-S6, U1-U2, W1), 2-6-11.0 (A1-A2), 2-6-11.1 (Seg. B), 2-6-14.0 (Seg. A1-A4), 2-6-14.1 (Seg. A1), and 2-6-14.2 (Seg. B1-B3), under the terms of Exhibit D, "Road Maintenance Specifications", of this contract which is attached hereto and made a part hereof.

5) Default by the Purchaser of said Right-of-Way and Road Use Agreement or any license agreement executed pursuant thereto, shall be considered a violation of this contract. The amount of unpaid fees shall be considered as the amount of damage suffered by the Government as a result of the violation of this provision. The Purchaser will be required to carry liability insurance with the limits of \$1,000,000/\$1,000,000/\$1,000,000 and a performance bond of \$10,000.

Road No. and Segment	Length Miles Used	Road Control	Road Surface Type	Maintenance Responsibility
2-5-10.0 (Seg. O16- M1, K4-K1, I3-I1, G4-E, C-A)	7.089	Weyerhaeuser	Rocked	Weyerhaeuser
2-5-29.1 (Seg. O, Q, S1-S6, U1-U2, W1)	0.945	Weyerhaeuser	Rocked	Purchaser
2-6-3.0 (A1-A3)	0.729	Weyerhaeuser	Rocked	Weyerhaeuser
2-6-9.1 (Seg. A1-A7)	0.792	Weyerhaeuser	Rocked	Weyerhaeuser
2-6-11.0 (A1-A2)	0.309	Weyerhaeuser	Rocked	Purchaser
2-6-11.1 (Seg. B)	0.246	Weyerhaeuser	Rocked	Purchaser
2-6-12.1 (Seg. A, C-D4)	0.491	Weyerhaeuser	Rocked	Weyerhaeuser
2-6-14.0 (Seg. A1-A4)	0.431	Weyerhaeuser	Rocked	Purchaser
2-6-14.1 (Seg. A1)	0.039	Weyerhaeuser	Rocked	Purchaser
2-6-14.2 (Seg. B1-B3)	0.234	Weyerhaeuser	Rocked	Purchaser

t. The Purchaser agrees that if they Request to use any other private road, subject of a right-of-way agreement with the Government for the removal of Government timber sold under the terms of this contract, and is approved by the Authorized Officer, Purchaser shall request and agree to the modification of this contract to provide for such use and for allowances for amortization of the Government's shares of the capital investment of any such road.

u. With the prior written approval of the Authorized Officer, the Purchaser may arrange for cooperative maintenance with other users of roads included in Exhibit E; provided, that such cooperative arrangement shall not relieve the Purchaser of their liability for the maintenance and repair of such roads resulting from wear or damage, in accordance with this contract. The Purchaser shall furnish the Authorized Officer a copy of any cooperative maintenance agreements entered into with other users of these roads.

v. The Purchaser shall perform any road repair and maintenance work on roads used (and designated as Purchaser Maintenance), under the terms of Exhibit D, "Road Maintenance Specifications", of this contract which is attached hereto and made a part hereof. Purchaser shall spread **255** cubic yards of crushed rock on non-BLM controlled roads used for this timber sale, as directed by the Authorized Officer as part of maintenance requirements.

### ENVIRONMENTAL PROTECTION

w. In order to prevent the spread of noxious weeds, the Purchaser shall pressure wash all road construction and ground-based logging equipment that will be used off of existing roads, as well as loaders and mechanically propelled brush cutters, prior to entry onto the BLM Land shown on Exhibit A, as directed by the Authorized Officer. Cleaning shall be defined as removal of all dirt, grease, plant parts and material that may carry noxious weed seeds.

x. In order to prevent the spread of noxious weeds, gravel sources for road construction, renovation, improvement, and maintenance must be approved by BLM prior to use.

y. The Purchaser shall immediately discontinue specified construction or harvesting operations upon written notice from the Contracting Officer that:

1. threatened or endangered plants or animals protected under the Endangered Species Act of 1973, as amended, may be affected by the operation, and a determination is made that consultation or reinitiation of consultation is required concerning the species prior to continuing operation, or;

2. when, in order to comply with the Endangered Species Act, or to prevent incidental take of northern spotted owls in accordance with management direction in the Record of Decision (ROD) and Resource Management Plan (RMP), or to protect occupied marbled murrelet sites in accordance with management direction of the ROD and RMP, the Contracting Officer determines it may be necessary to modify or terminate the contract, or;

3. federal proposed, federal candidate, Bureau sensitive or State listed species protected under BLM Manual 6840 - Special Status Species Management - have been identified, and a determination is made that continued operations would affect the species or its habitat, or;
4. when, in order to comply with a court order, which enjoins operations on the sale or otherwise requires the Bureau of Land Management to suspend operations, or;
5. when, in order to comply with a court order, the Contracting Officer determines it may be necessary to modify or terminate the contract, or;
6. species have been discovered which were identified for protection in accordance with management direction established in the ROD and RMP, and the Contracting Officer determines that continued operations would affect the species or its habitat, or;
7. when, in order to protect species which were identified for protection in accordance with management direction established in the ROD and RMP, the Contracting Officer determines it may be necessary to modify or terminate the contract.

Those operations necessary for a safe removal of personnel and equipment from the contract area and those directed by the Contracting Officer, which are required in order to leave the contract area in an acceptable condition will be permitted. Discontinued operations may be resumed upon receipt of written instructions and authorization by the Contracting Officer.

During any period of suspension, the Purchaser may withdraw performance and payment bond coverage aside from that deemed necessary by the Authorized Officer to secure cut and/or removed timber for which the Bureau of Land Management has not received payment, and/or unfulfilled contract requirements associated with harvest operations that have already occurred and associated post-harvest requirements.

In the event of a suspension period or a combination of suspension periods that exceed a total of 30 days, the First Installment held on deposit may be temporarily reduced upon the written request of the Purchaser. For the period of suspension extending beyond 30 days, the First Installment on deposit may be reduced to five (5) percent of the First Installment amount listed in Section 3.b. of the contract. Any First Installment amount temporarily reduced may be refunded or transferred to another BLM contract at the request of the Purchaser. However, if the Purchaser has outstanding debt owing the United States, the Contracting Officer must first apply the amount of First Installment that could be refunded to the debt owed in accordance with the Debt Collection Improvement Act, as amended (31 USC 3710, et seq.). Upon Purchaser's receipt of a bill for collection and written notice from the Contracting Officer lifting the suspension, the Purchaser shall restore the First Installment to the full amount shown in Section 3.b. of the contract within 15 days after the bill for collection is issued, subject to Section 3.j. of the contract. The Purchaser shall not resume contract operations until the First Installment amount is fully restored.

In the event of a suspension period or a combination of suspension periods that exceed a total of 30 days, the unamortized Out-of-Pocket Expenses for road or other construction required pursuant to Exhibit C of the contract shall be refunded or transferred to another BLM contract at the request of the Purchaser. Upon written notice from the Contracting Officer lifting the suspension, the



Purchaser shall reimburse the Government the amounts refunded or transferred. The Purchaser may choose to pay this reimbursement at once or in installments payable at the same time as payments are due for the timber under the contract and in amounts approximately equal to the expenses associated with the timber for which payment is due.

In the event that operating time is lost as a result of the incorporation of additional contract requirements, or delays due to Endangered Species Act consultation with the U.S. Fish and Wildlife Service or U.S. National Marine Fisheries Service, or court-ordered injunctions, the Purchaser agrees that an extension of time, without reappraisal, will constitute a full and complete remedy for any claim that delays due to the suspension hindered performance of the contract or resulted in damages of any kind to the Purchaser.

The Contracting Officer may determine that it is necessary to modify the contract or terminate the cutting and removal rights under the contract in order to comply with the Endangered Species Act, prevent incidental take of northern spotted owls in accordance with the ROD and RMP, protect occupied marbled murrelet sites in accordance with the ROD and RMP, protect species that have been discovered which were identified for protection in accordance with management direction established in the ROD and RMP, or comply with a court order. Following the issuance of a written notice that cutting and removal rights will be terminated, the Purchaser will be permitted to remove timber cut under the contract, if allowed by the Endangered Species Act, if able to proceed without causing incidental take of northern spotted owls in accordance with the ROD and RMP, consistent with marbled murrelet occupied site protection in accordance with the ROD and RMP, consistent with species protection in accordance with management direction established in the ROD and RMP, or court order requirements necessitating the modification or termination.

In the event the contract is modified or cutting and removal rights are terminated under this subsection, the Purchaser agrees that the liability of the United States shall be limited to the actual costs incurred by the Purchaser which have not been amortized by timber removed from the contract area. This calculation of liability shall utilize actual Purchaser costs and Government estimates of timber volumes. At the Authorized Officer's request, the Purchaser agrees to provide documentation of the actual costs incurred in the performance of the contract. In addition, the Purchaser shall be released from the obligation to pay the contract price for any timber which is not authorized to be removed from the contract area.

The Purchaser specifically and expressly waives any right to claim damages, other than those described in the preceding paragraphs, based on an alleged breach of any duty to the Purchaser, whether express or implied, in regard to the manner in which the Government defended the litigation which resulted in the court order affecting the operation of the contract. This waiver also extends to any claims based on effects on the operation of the contract that arise from litigation against another agency. Furthermore, the Purchaser specifically acknowledges and agrees that a court ruling that the Government violated the Administrative Procedures Act cannot be interpreted, in itself, to mean that the Government had not acted reasonably in regard to its duties to the Purchaser under this contract.

#### FIRE PREVENTION

z. Primarily for purposes of fire prevention and control, the Purchaser shall, prior to the operation of power driven equipment in construction or logging operations under this contract during the fire season or periods of fire danger, prepare a fire prevention and control plan to the satisfaction of the Authorized Officer. Purchaser shall take such measures for prevention and suppression of fire on the contract area and other adjacent Government lands used or traversed by Purchaser in connection with operations as are required by applicable laws and regulations. However, when in the opinion of the Authorized Officer, weather and other conditions affecting fire incidence and control make special precautions necessary to protect the contract area and said Government lands, Purchaser shall take such additional or other fire prevention and control measures as may be required by the Authorized Officer. The Purchaser shall comply with Oregon Department of Forestry Industrial Fire Precaution Level (IFPL) I Fire Season requirements. At IFPL II and III, additional fire prevention and control provisions may be added as determined by the Authorized Officer and specified in written instructions to the Purchaser to mitigate dry fuel and weather conditions.

### LOGGING RESIDUE REDUCTION

aa. In addition to the requirements of Sec. 15 of this contract, and notwithstanding the Purchasers satisfactory compliance with State laws and regulations regarding offsetting or abating the additional fire hazard created by this operation and the State's willingness to release the Purchaser from liability for such hazard, the Purchaser shall remain responsible to the Government for performance of the following hazard reduction measure(s) required by this contract: Perform logging residue reduction and site preparation work on approximately twenty four (24) acres of harvest area located within harvest units. The required work shall consist of any treatment or combination of treatments, as determined by the Authorized Officer and specified in writing by the Contracting Officer. The number of acres of each treatment shall be determined by the Authorized Officer. Prior to commencement of any operation under this Section of the contract, a slash disposal and pre-work conference between the purchaser's representative and the Authorized Officer must be held at a location designated by the Authorized Officer. The number of acres of each treatment shall be determined by the Authorized Officer. All slash disposal shall be done in accordance with the plans developed at this pre-work conference. Slash, as defined for this section, shall mean all material (brush, limbs, tops, unmerchantable stems, and chunks) severed or knocked over as a result of purchasers operations under the terms of this contract.

1. Machine pile and burn slash within ground based portion of regeneration harvest units from skid trails and within 25 feet of 2-6-9.1, 2-6-12.1, and 2-5-29.1 roads in harvest areas. Slash shall be piled by a machine equipped with a hydraulic thumb or grapple. Finished piles shall be tight and free of dirt.

a. Unmerchantable logs greater than six (6) inches on the small end shall be left in place, or positioned so that they will not be burned.

b. Slash less than six (6) inches in diameter would be less than one (1) foot in height.

c. Machine piles shall be located as far as possible from green trees, snags, or unit boundaries to minimize damage.

d. Machine piles shall be kept free of dirt and other non-wood debris and constructed as compactly as possible. There should be an adequate supply of finer fuels located within and under the covered area of the pile to ensure ignition of the larger fuels.

e. A minimum 10-foot by 10-foot cover of four (4) mil (0.004 inch) thick polyethylene shall cap each machine pile to maintain a dry ignition point. The cover shall be firmly fixed to each pile to hold it in place. Plastic shall be held in place with woody debris or tied with rope or twine. The plastic must be secured so that it is held in place during strong wind conditions. The Purchaser is required to furnish the covering materials. Covering shall be completed as directed by the Authorized Officer.

f. Cutting Areas shall be piled during the same season that they are logged.

2. Pile and burn landing slash within thirty (30) feet of the edge of each landing, all tops, broken pieces, limbs and debris more than one (1) inch in diameter at the large end and longer than three (3) feet in length shall be piled within fifteen (15) days of completion of hauling logs from that landing. Landing piles shall be kept free of dirt and located adjacent to roads at least twenty (20) feet from any Reserve Tree and/or as directed by the Authorized Officer. Upon completion of landing piling, the Purchaser shall prepare the landing piles for burning by securely covering each landing pile with four (4) mil (0.004 inch) thick polyethylene plastic film at least 10 feet wide. Landing piles shall be covered sufficiently to allow for ignition in wet conditions as approved by the Authorized Officer. The plastic shall be oriented southwest to northeast. Pieces of burnable material shall be placed on top of the plastic to secure it from moving and to prevent it from blowing off during strong wind episodes. The Purchaser is required to furnish the covering materials. The timing of this covering work shall be in accordance with instructions from the Authorized Officer. No landing debris shall be dozed off the landing and covered with dirt. Debris which has been buried and is determined to be the source of holdover fire shall be excavated by the Purchaser, at the Purchaser's expense, with a tractor and/or hydraulic excavator as directed by the Authorized Officer. If the structure of the landing piles will not permit adequate consumption of piled debris by burning, the Purchaser shall re-pile them at the direction of the Authorized Officer.

bb. Notwithstanding the provisions of Sec. 15 of this contract, the Government shall assume all obligations for disposal or reduction of fire hazards created by Purchaser's operations on Government lands, except for burning and mop-up assistance as required herein and measures required in Sec. 42.aa.. The Purchaser shall, under supervision of the Authorized Officer or designated representative, assist in preparing units for burning, burning, mop-up, and patrol by furnishing, at the Purchaser's own expense, the services of personnel and equipment on each unit as shown below:

1. For Igniting, Burning, Mop-up of Piles on Units:

a. One work leader(s) Firefighter Type 1 (FFT1) qualified according to National Wildfire Coordinating Group (NWCG) Wildland Fire Qualifications System guide, PMS 310-1) to supervise crew and equipment operations, and to serve as Purchaser's representative.

b. Five-person crew Firefighter Type 2 (FFT2) qualified according to National Wildfire Coordination Group (NWCG) Wildland Fire Qualifications System guide, PMS 310-1, with sufficient fuel for burning, six (6) drip torches, one (1) power saw, one (1) backpack pump, and one (1) tool for each crew member.

c. The crew shall arrive on the project area with radios capable of inter-crew communications and communication with a BLM representative at a ratio of one (1) radio per every five (5) crewmembers.

d. All ignition and mop-up personnel will be directly supervised by a BLM representative.

Aircraft and pilots used for Logging Residue Reduction or the suppression of escaped fires from Logging Residue Reduction operations, shall be acquired from a list of aircraft and pilots approved (i.e., carded for these specific activities) by the Office of Aircraft Services or the U.S. Forest Service. This list is available from BLM District Offices upon request.

All listed personnel shall be physically fit, experienced and fully capable of functioning as required. In addition, all listed personnel shall be qualified according to the National Wildfire Coordinating Group (NWCG) Wildland Fire Qualification System Guide, PMS-310-1 and provide documentation of these qualifications. On the day of ignition all listed personnel shall be fluent in speaking and understanding English, clothing shall consist of long pants and long sleeved shirts, and be of approved aramid fabric (Nomex™ or equivalent), as well as being free of diesel fuel oil. All personnel shall wear lug sole boots with minimum eight (8) inch tall uppers that provide ankle support, approved hardhats, and leather gloves. Personnel who do not meet these requirements or do not have proper clothing and personal protective equipment (PPE) will not be allowed to participate. All listed tools and equipment shall be in good usable condition. All power-driven equipment shall be fully fueled and available for immediate use. During periods of use under this subsection, the Purchaser shall provide fuel and maintenance for all such power-driven equipment.

Except as provided hereafter for fire escapement, the Purchaser shall continue the required assistance in mop up on each cutting unit shown on Exhibit A for seventy-two (72) hours, as directed by the Authorized Officer within a five (5) day period commencing at 8:00 a.m. the day following the completion of ignition in that unit, or until released from such service by the Government, whichever occurs first.

In event of a fire escapement, the Purchaser's personnel and equipment shall, under supervision of the Authorized Officer, take action to control and mop up the escaped fire until released from such service by the Government. If it becomes necessary to use furnished personnel and equipment for the suppression of a fire which escapes from the prescribed fire area for a period beyond the remainder of the day in which the fire escapes, then the Government shall, at its option: (1) reimburse the Purchaser for such additional use of personnel and equipment at wage rates shown in the current Administratively Determined Pay Rates for the Western Area and at equipment rates shown in the current Oregon-Washington Interagency Fire Fighting Equipment Rental Rates schedule until the Purchaser is released from such service by the Government; or (2) release the Purchaser from additional suppression work and assume responsibility for suppressing the escaped fire.

In situations where an escaped fire is controlled and contained by an adequate fire break (i.e., trail, road, stream, rock formation, etc.), the Government may permit the Purchaser to remove personnel for that day; provided that all mop up work on the escaped fire is included with mop up work on the prescribed fire area. In such an event, the Purchaser must sign a statement of agreement to complete mop up work on all escaped fire areas concurrently with mop up work on the prescribed fire area.

In case of injury to personnel or damage to equipment furnished as required by this subsection, liability shall be borne by the Purchaser, unless such injury or damage is caused by Government negligence.

Time is of the essence in complying with this provision. In the event the Purchaser fails to provide the personnel and equipment required herein, the Purchaser shall be responsible for all additional cost incurred by the Government in disposing of slash including but not limited to the wages and other costs of providing federal employees and others as substitute labor force, the cost of providing substitute equipment and appropriate additional overhead expenses. If the Purchaser's failure results in a deferral of burning and new conditions necessitate additional personnel and equipment to accomplish the planned burn, the Purchaser also shall be responsible for such additional costs.

#### CREATION OF COARSE WOODY DEBRIS

cc. In the Coarse Woody Debris Creation Units shown on Exhibit F, the Purchaser shall, upon completion of yarding, select and fall, top, high-girdle, or basal-girdle five hundred eighty-two (582) standing live trees in accordance with Exhibit F. No adjustments of volume or value shall be made to meet these requirements.

#### CONTRIBUTIONS

dd. The Purchaser shall create coarse woody debris in accordance with Section 42.cc. The Purchaser shall have the option of completing this work, or in lieu thereof, may make a contribution to the Bureau of Land Management in the amount of forty-five thousand nine hundred thirty-five and 86/100 dollars (\$45,935.86) and upon making such contribution, the Purchaser shall be relieved of the obligations set out in this subsection. The Purchaser shall notify the Authorized Officer of their intention to make this contribution prior to the date of execution of this contract, and the Purchaser shall pay such amount in full prior to the commencement of operations.

#### LOG EXPORT RESTRICTION

ee. All timber sold to the Purchaser under the terms of the contract, except exempted species, is restricted from export under the United States in the form of unprocessed timber, and is prohibited from being used as a substitute for exported private timber. For the purpose of this contract, unprocessed timber is defined as (1) any logs except those of utility grade or below, such as saw logs, peeler logs, and pulp logs; (2) cants or squares to be subsequently remanufactured exceeding eight and three-quarters (8-3/4)

inches in thickness; (3) split or round bolts or other round wood not processed to standards and specifications suitable for end-product uses; or (4) western red cedar lumber which does not meet lumber of American Lumber Standards Grades of Number 3 dimension or better, or Pacific Lumber Inspection Bureau R-List Grades of Number 3 Common or better.

Thus, timber manufactured into the following will be considered processed: (1) lumber and construction timbers, regardless of size, manufactured to standards and specifications suitable for end product uses; (2) chips, pulp and pulp products; (3) green or dry veneer and plywood; (4) poles and piling cut or treated for use as such; (5) cants, squares, and lumber cut for remanufacturing of eight and three-quarters (8-3/4) inches in thickness or less; (6) shakes and shingles. Substitution will be determined under the definition found in 43 CFR 5400.0-5(n).

The Purchaser is required to maintain and upon request to furnish the following information:

1. Date of last export sale.
2. Volume of timber contained in last export sale.
3. Volume of timber exported in the past twelve (12) months from the date of last export sale.
4. Volume of Federal timber purchased in the past twelve (12) months from date of last export sale.
5. Volume of timber exported in succeeding twelve (12) months from date of last export sale.
6. Volume of Federal timber purchased in succeeding twelve (12) months from date of last export sale.

In the event the Purchaser elects to sell any or all of the timber sold under this contract in the form of unprocessed timber, the Purchaser shall require each party buying, exchanging, or receiving such timber to execute a "Certificate as to Nonsubstitution and Domestic Processing of Timber". The original of such certification shall be filed with the Authorized Officer.

Additionally, when the other party is an affiliate of the Purchaser, the Purchaser will be required to update information under item (2) of Form 5450-17 (Export Determination) and file the form with the Authorized Officer.

In the event an affiliate of the Purchaser has exported private timber within twelve (12) months prior to purchasing or otherwise acquiring Federal timber sold under this contract, the Purchaser shall, upon request, obtain from the affiliate information in the form specified by the Authorized Officer and furnish the information to the Authorized Officer.

Prior to the termination of this contract, the Purchaser shall submit to the Authorized Officer Form 5460-15 (Log Scale and Disposition of Timber Removed Report) which shall be executed by the Purchaser. In addition, the Purchaser is required under the terms of this contract to retain for a three-year period from the date of termination of the contract the records of all sales or transfer of logs involving timber from the sale for inspection and use of the Bureau of Land Management.

Unless otherwise authorized in writing by the Authorized Officer, the Purchaser shall, prior to the removal of timber from the contract area, brand with Purchaser's registered log brand at least one end of each log, bolt, or other roundwood and identify each of these by painting with highway yellow paint.

In the event of the Purchaser's noncompliance with this subsection of the contract, the Authorized Officer may take appropriate action as set forth in Sec. 10. of this contract. In addition, the Purchaser may be declared ineligible to receive future awards of Government timber for a period of one (1) year.

Unless otherwise authorized in writing by the Contracting Officer, the Purchaser shall brand clearly and legibly one end of all logs with a scaling diameter (small end inside bark) of over ten (10) inches, prior to the removal of timber from the contract area. All loads of eleven (11) logs or more will have a minimum of ten (10) logs clearly and legibly branded on one end regardless of the diameter of the logs. All logs will be branded on loads of ten (10) logs or less. One end of all branded logs to be processed domestically will be marked with a three (3) square inch spot of highway yellow paint. The Purchaser will stop trucks for accountability monitoring at mutually agreed upon locations when notified by the Authorized Officer.

If multiple trailers (mule trains) are used, each bunked load shall be considered an individual load, and these guidelines will apply to each bunked load. If a flatbed stake trailer is used, each bundle will be treated as a separate load.

At the discretion of the Contracting Officer, the Purchaser may be required to brand and paint all logs. Any increased costs for log branding and painting shall be the responsibility of the Purchaser.



United States Department of the Interior  
 BUREAU OF LAND MANAGEMENT  
 TIMBER SALE CONTRACT MAP

Contract No. ORN04-TS-2020.0402  
 Fairchild Timber Sale  
 Exhibit A  
 Page 1 of 2

6/10/2020

T. 2S. R. 6W, Section 10 and 11 W. M. - NORTHWEST OREGON DISTRICT - OREGON

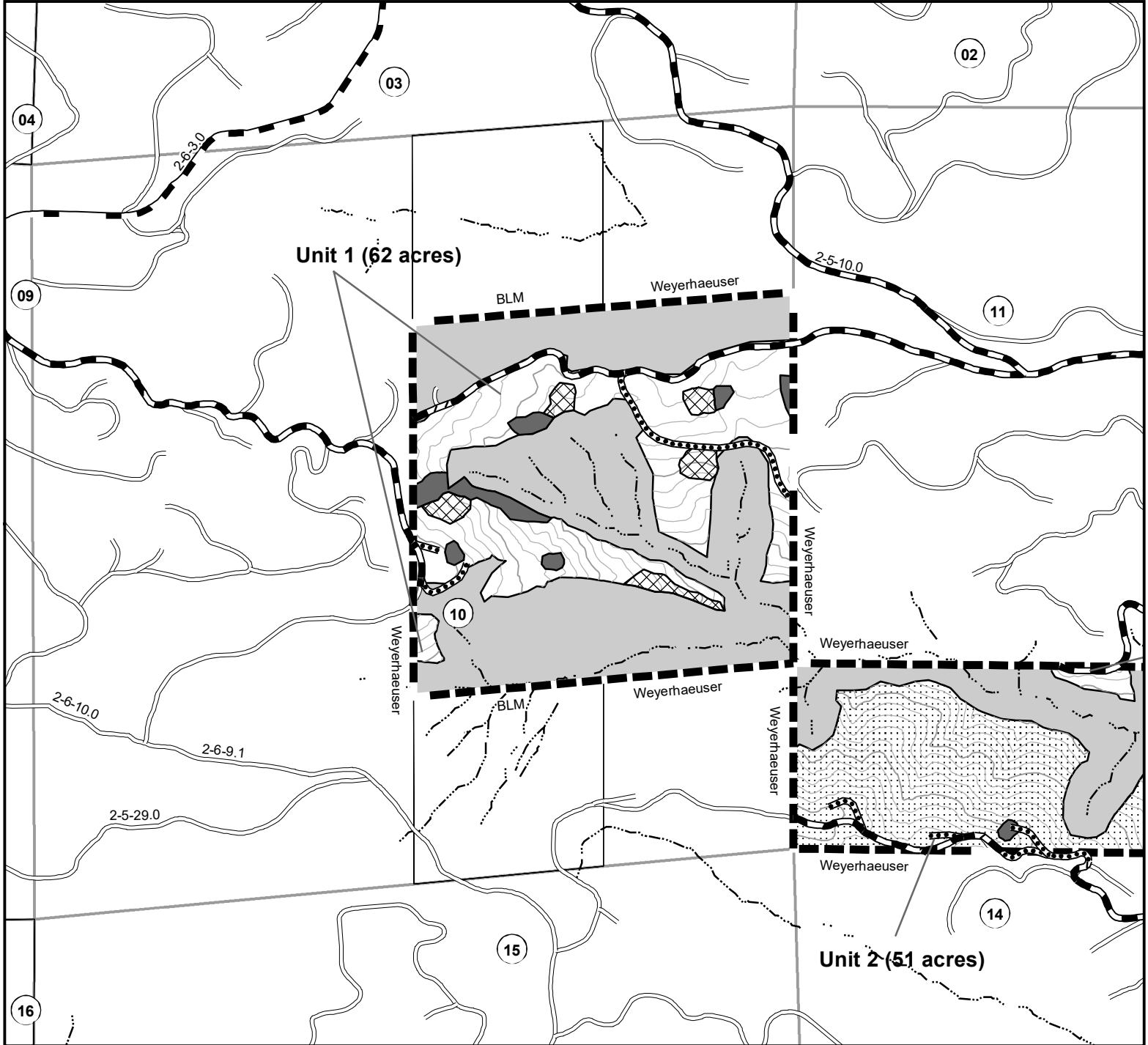

Partial Cut Area	215 acres
Regeneration Cut Area	65 acres
Right-of-Way	3 acres
Reserve Area	325 acres
Clump	21 acres
Patch Cut	19 acres
<b>Total Contract Area</b>	<b>613 acres</b>

Contour Interval: 40 feet

0 500 1,000 2,000 3,000 Feet

	Fairchild Contract Area		Road to be constructed
	Partial Cut		Road to be improved
	Regeneration Harvest		Road to be renovated
	Clump		Existing Roads
	Patch Cut		Streams
	Reserve Area		

No warranty is made by the Bureau of Land Management as to the accuracy, reliability, or completeness of these data for individual or aggregate use with other data. Original data were compiled from various sources and may be updated without notification. Note: Boundaries of harvest area and rights-of-ways (ROW) are painted orange and posted. Harvest area acres do not include existing roads. Acres shown on Exhibit A for harvest area have been computed using a S1 mobile mapper and Trimble R1 GNSS Receiver. Prepared By: dtyler





United States Department of the Interior  
 BUREAU OF LAND MANAGEMENT  
 TIMBER SALE CONTRACT MAP

Contract No. ORN04-TS-2020.0402  
 Fairchild Timber Sale  
 Exhibit A  
 Page 2 of 2

6/10/2020

T. 2S. R. 6W, Section 11, 13, and 14 W. M. - NORTHWEST OREGON DISTRICT - OREGON

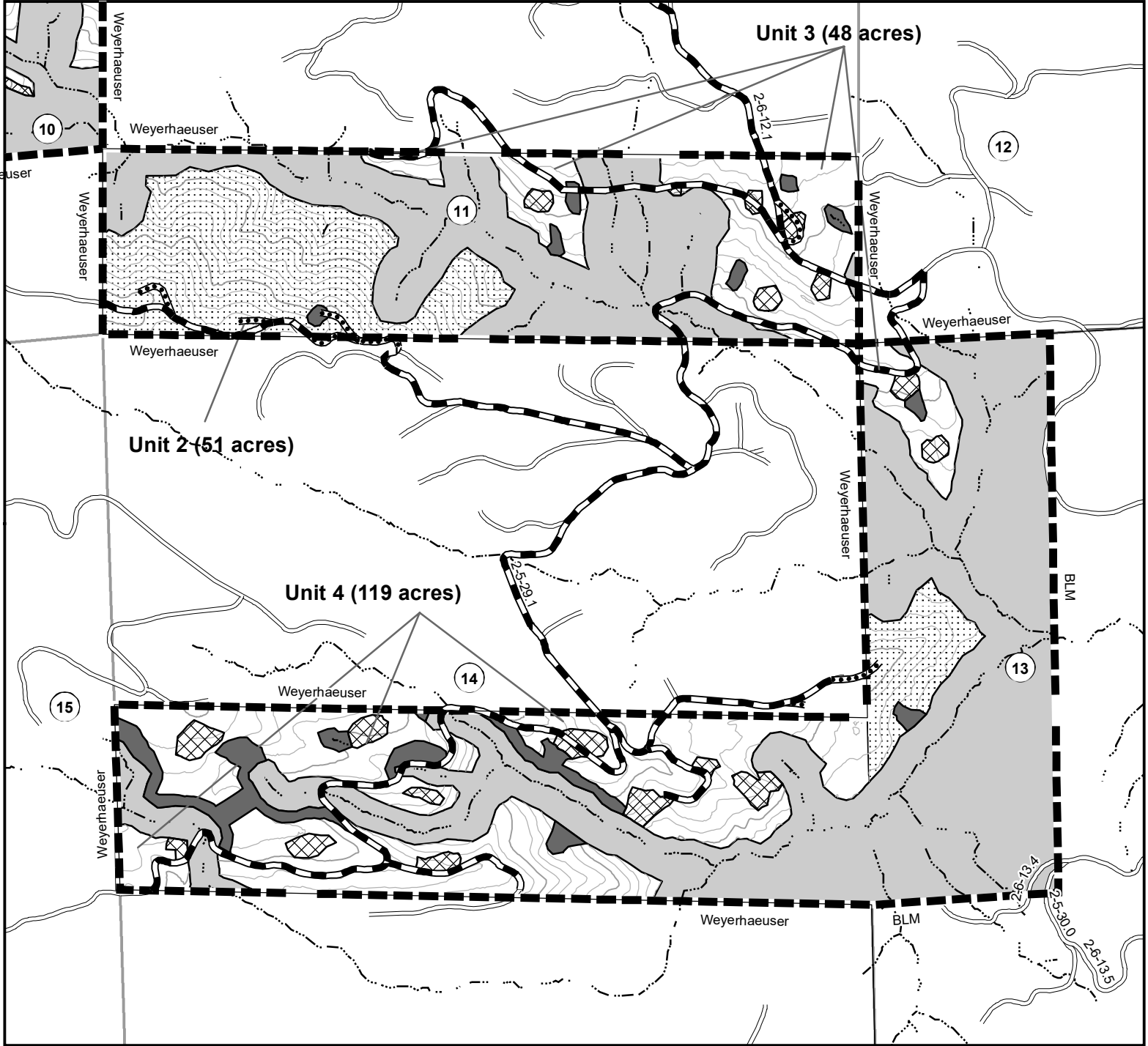

Partial Cut Area	215 acres
Regeneration Cut Area	65 acres
Right-of-Way	3 acres
Reserve Area	325 acres
Clump	21 acres
Patch Cut	19 acres
<b>Total Contract Area</b>	<b>613 acres</b>

Contour Interval: 40 feet

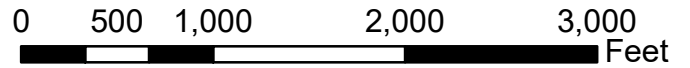

- Fairchild Contract Area
- Partial Cut
- Regeneration Harvest
- Clump
- Patch Cut
- Reserve Area
- Road to be constructed
- Road to be improved
- Road to be renovated
- Existing Roads
- Streams

No warranty is made by the Bureau of Land Management as to the accuracy, reliability, or completeness of these data for individual or aggregate use with other data. Original data were compiled from various sources and may be updated without notification. Note: Boundaries of harvest area and rights-of-ways (ROW) are painted orange and posted. Harvest area acres do not include existing roads. Acres shown on Exhibit A for harvest area have been computed using a S1 mobile mapper and Trimble R1 GNSS Receiver. Prepared By: dtyler

UNITED STATES  
DEPARTMENT OF THE INTERIOR  
BUREAU OF LAND MANAGEMENT

Contract No.  
ORN04-TS-2020.0402  
Fairchild

**EXHIBIT B / PRE-SALE**

5450-3

The following estimates and calculations of value of timber sold are made solely as an administrative aid for determining: (1) adjustments made or credits given in accordance with Secs. 6, 9, or 11; (2) when payments are due; and (3) value of timber subject to any special bonding provisions. The value of timber will be determined by multiplying the value per acre as shown below, times the amount of acreage as determined by the Authorized Officer, which has been cut or removed or designated for taking. Except as provided in Sec. 2, Purchaser shall be liable for total purchase price even though quantity of timber actually cut or removed or designated for taking is less than the estimated volume or quantity shown. Cutting areas are shown on **Exhibit A**.

SPECIES	ESTIMATED VOLUME OR QUANTITY <i>(Units Specified)</i>		PRICE PER UNIT	ESTIMATED VOLUME OR QUANTITY X UNIT PRICE
Douglas Fir	10,536.0	MBF	\$158.50	\$1,669,956.00
Western Hemlock	79.0	MBF	\$34.90	\$2,757.10
Bigleaf Maple	55.0	MBF	\$26.00	\$1,430.00
Red Alder	23.0	MBF	\$29.60	\$680.80
Western Redcedar	2.0	MBF	\$258.80	\$517.60
<b>TOTALS</b>	<b>10,695.0</b>	<b>MBF</b>		<b>\$1,675,341.50</b>

The apportionment of the total purchase price is as follows:

Unit 1

Douglas Fir	2,294.0 MBF	X	\$158.50	=	\$363,599.00
Western Hemlock	17.0 MBF	X	\$34.90	=	\$593.30
Bigleaf Maple	12.0 MBF	X	\$26.00	=	\$312.00
Red Alder	5.0 MBF	X	\$29.60	=	\$148.00
<b>Total</b>	<b>2328.0 Mbf</b>				<b>\$364,652.30 ÷ 62.0 acres = \$5,881.49/Acre</b>

Unit 2

Douglas Fir	2,010.0 MBF	X	\$158.50	=	\$318,585.00
Western Hemlock	15.0 MBF	X	\$34.90	=	\$523.50
Bigleaf Maple	11.0 MBF	X	\$26.00	=	\$286.00
Red Alder	4.0 MBF	X	\$29.60	=	\$118.40
<b>Total</b>	<b>2040.0 Mbf</b>				<b>\$319,512.90 ÷ 51.0 acres = \$6,264.96/Acre</b>

Unit 3

Douglas Fir	1,809.0 MBF	X	\$158.50	=	\$286,726.50
Western Hemlock	14.0 MBF	X	\$34.90	=	\$488.60
Bigleaf Maple	10.0 MBF	X	\$26.00	=	\$260.00
Red Alder	4.0 MBF	X	\$29.60	=	\$118.40
<b>Total</b>	<b>1837.0 Mbf</b>				<b>\$287,593.50 ÷ 48.0 acres = \$5,991.53/Acre</b>

Unit 4

Douglas Fir	4,302.0 MBF	X	\$158.50	=	\$681,867.00
Western Hemlock	32.0 MBF	X	\$34.90	=	\$1,116.80
Bigleaf Maple	21.0 MBF	X	\$26.00	=	\$546.00
Red Alder	9.0 MBF	X	\$29.60	=	\$266.40
Western Redcedar	2.0 MBF	X	\$258.80	=	\$517.60

UNITED STATES  
DEPARTMENT OF THE INTERIOR  
BUREAU OF LAND MANAGEMENT

**EXHIBIT B / PRE-SALE**

5450-3

Contract No.

ORN04-TS-2020.0402

Fairchild

The following estimates and calculations of value of timber sold are made solely as an administrative aid for determining: (1) adjustments made or credits given in accordance with Secs. 6, 9, or 11; (2) when payments are due; and (3) value of timber subject to any special bonding provisions. The value of timber will be determined by multiplying the value per acre as shown below, times the amount of acreage as determined by the Authorized Officer, which has been cut or removed or designated for taking. Except as provided in Sec. 2, Purchaser shall be liable for total purchase price even though quantity of timber actually cut or removed or designated for taking is less than the estimated volume or quantity shown. Cutting areas are shown on **Exhibit A.**

Total	4366.0 Mbf	\$684,313.80	÷	119.0 acres = \$5,750.54/Acre
-------	------------	--------------	---	-------------------------------

Unit RW

Douglas Fir	121.0 MBF	X	\$158.50	=	\$19,178.50
Western Hemlock	1.0 MBF	X	\$34.90	=	\$34.90
Bigleaf Maple	1.0 MBF	X	\$26.00	=	\$26.00
Red Alder	1.0 MBF	X	\$29.60	=	\$29.60
<hr/>					
Total	124.0 Mbf		\$19,269.00	÷	3.0 acres = \$6,423.00/Acre

**TABLE OF CONTENTS**

SECTION	PAGE	DESCRIPTION
	1-2	Table of Contents/Road Specifications
100	3-9	General
150	10-13	Road Plan and Detail Sheets
200	14-15	Clearing and Grubbing
300	15-18	Excavation and Embankment
400	19-22	Pipe Culverts
500	22-23	Renovation and Improvement of Existing Roads
600	23-24	Watering
700	24-25	Aggregate Base Course – Pit-run Rock
900	25-26	Aggregate Base Course - Screened Rock
1000	27-29	Aggregate Base Course - Crushed Rock
1200	29-32	Aggregate Surface Course - Crushed Rock
1300	32-34	Geotextiles
1400	34-36	Slope Protection
1700	36-37	Erosion Control
1800	37-38	Soil Stabilization
2100	38-40	Roadside Brushing
2300	40-41	Slope Staking
2700	41	Barricades and Control Devices
	42-43	Road Plan Maps
	44	Earth Barricade, Waterdip, Drivable and Non-Drivable Waterbar Details
	45	Brushing Details
	46-53	Culvert List
	54	Culvert Band Details
	55	Culvert Installation Details
	56	Rock Volumes Totals

**U.S. DEPARTMENT OF THE INTERIOR  
Bureau of Land Management  
Northwest Oregon District – OREGON  
TIMBER SALE CONTRACT  
ROAD SPECIFICATIONS**

<b>Road Number And Segment</b>	<b>New Construction (Stations and Miles)</b>	<b>Improvement (Stations and Miles)</b>	<b>Renovation (Stations and Miles)</b>
2-5-10.0			<b>403+76 Sta. = 7.647 Mi.</b>
2-5-29.1			<b>125+40 Sta. = 2.375 Mi.</b>
2-6-3.0			<b>38+49 Sta. = 0.729 Mi.</b>
2-6-9.1			<b>46+04 Sta. = 0.872 Mi.</b>
2-6-10.1	<b>17+63 Sta. = 0.334 Mi.</b>		
2-6-10.2	<b>1+62 Sta. = 0.031 Mi.</b>		
2-6-10.3	<b>4+38 Sta. = 0.083 Mi.</b>		
2-6-11.0		<b>1+66 Sta. = 0.031 Mi.</b>	<b>44+13 Sta. = 0.836 Mi.</b>
2-6-11.1	<b>4+33 Sta. = 0.082 Mi.</b>		<b>38+47 Sta. = 0.729 Mi.</b>
2-6-11.2	<b>4+49 Sta. = 0.085 Mi.</b>		
2-6-11.3	<b>2+83 Sta. = 0.054 Mi.</b>		
2-6-12.1			<b>37+49 Sta. = 0.710 Mi.</b>
2-6-14.0			<b>22+75 Sta. = 0.431 Mi.</b>
2-6-14.1		<b>2+06 Sta. = 0.039 Mi.</b>	
2-6-14.2	<b>3+87 Sta. = 0.073 Mi.</b>		<b>17+80 Sta. = 0.337 Mi.</b>
2-6-14.3			<b>12+16 Sta. = 0.230 Mi.</b>
2-6-14.4			<b>10+64 Sta. = 0.202 Mi.</b>
2-6-14.5	<b>1+50 Sta. = 0.028 Mi.</b>		
2-6-14.6	<b>3+62 Sta. = 0.069 Mi.</b>		
2-6-15.4	<b>7+88 Sta. = 0.149</b>	<b>1+93 Sta. = 0.037 Mi.</b>	<b>13+70 Sta. = 0.259 Mi.</b>

**GENERAL – 100**

101 - Pre-work Conference(s):

A pre-work conference will be held prior to the start of new construction, renovation, quarry development, and decommissioning operations. The Purchaser shall request the conference at least forty-eight (48) hours prior to the time it is to be held. The conference will be attended by the Purchaser and/or his representative(s), subcontractor(s) and/or his or their representative(s) and the Authorized Officer and/or his representative(s).

The purpose of the prework conference will be to review the required work, exhibits and specifications, and to establish a work schedule and a list of the Purchaser's representatives and subcontractor(s).

102 - Definitions:

AASHTO - American Association of State Highway and Transportation Officials. Current editions of tests and specifications.

Abrasion Resistance - The ability of a fabric surface to resist wear by friction.

Apparent Opening Size (AOS) - Number of the U.S. Bureau of Standard sieve (or its opening size in millimeters or inches) having openings closest in size to the diameter of uniform particles which will allow five (5) percent by weight to pass through the geotextile material when shaken in a prescribed manner. This is also referred to as Equivalent Opening Size (EOS).

ASTM - American Society for Testing and Materials.

Base Course - Surfacing structure consisting of crushed gravel or stone, crushed sandstone, pit-run rock, bank or river-run gravels, etc., to provide support and, in the event no surface course is placed, the running surface for traffic load.

BLM - Bureau of Land Management

Borrow - Excavated material required for embankments and other portions of the work.

Burst Strength - The resistance of a geotextile material to rupture from pressure applied at right angles to the plane of the geotextile material under specified conditions, usually expressed as the amount of pressure causing failure. Rupture or burst results from tensile failure of the geotextile material.

Culvert - A pipe, pipe-arch, arch, or box structure constructed of metal, concrete, plastic or wood which provides an opening under the roadway primarily for the conveyance of liquids, pedestrians or livestock.

Curve Widening - Widening required on inside of curves to accommodate long log and equipment hauling trucks.

Embankment - A structure of soil, aggregate, or rock material placed on a prepared ground surface and constructed to subgrade.

End Haul - Excavated material moved, other than by dozer, to an embankment or waste area to prevent sidecasting material outside of the road prism.

Excess Excavation - Material from the roadway in excess of that needed for construction of the designed roadway (waste).

Grab Tensile Strength - A modified tensile strength of a geotextile material. The strength of a specific width of geotextile material together with the additional strength contributed by adjacent areas. Typically, grab strength is determined on a 12-inch-wide strip of geotextile material, with the tensile load applied at the midpoint of the geotextile material width through 1-inch-wide jaw faces.

Grading - Leveling to grade, shaping and smoothing of a road subgrade; the shaping of roadside ditches as to grade and contour. In some instances includes smoothing of the cut bank.

Nonwoven Geotextile Material - A textile structure produced by bonding or interlocking of fibers, or both, accomplished by mechanical or chemical means.

Overhaul - Distance excavated material is transported in excess of the distance included in the cost for excavation.

Penetration Resistance - The geotextile material property determined by the force required to penetrate a geotextile material with a sharp pointed object. Initial penetration is by separating the fibers. Further penetration is essentially a tearing process.

Percent Open Area - The net area of a geotextile material that is not occupied by geotextile material filaments, normally determinable only for woven and nonwoven geotextile material having distinct, visible, and measurable openings that continue directly through the geotextile material.

Permeability - The geotextile material property which permits water to be transmitted in the longitudinal or transverse planes of the geotextile material.

Pioneer Road - Temporary construction access built along the route of the project.

Piping - The process by which soil particles are washed in or through pore spaces in drains and filters or poorly compacted fill/backfill material.

Plans - The approved drawings, or exact reproductions thereof which show the locations, character, dimensions, and details of the work to be done.

Pore Size - The size of an opening between geotextile material filaments; apparent opening size (AOS) is used to quantify this geotextile material property.

Puncture Resistance - The geotextile material property determined by the force required to penetrate a geotextile material with a blunt object. Failure results in a tearing of the geotextile material.

Purchaser - The individual, partnership, joint venture, or corporation contracting with the Government under the terms of a Timber Sale Contract and acting independently or through their, or its agents, employees, or contractors.

Reasonably Close Conformity - Compliance with reasonable and customary manufacturing and construction tolerances where working tolerances are not specified.

Reinforcement - Strengthening of concrete with iron bars or mesh: geotextile with geotextile material inclusion: subgrade with aggregate: etc.

Roadbed - The graded portion of the road within top and side slopes, prepared as a foundation for the pavement structure and shoulders.

Road Centerline - The longitudinal center of a roadbed.

Road Improvement - Work done to an existing road which improves it over its original design standard.

Road Renovation - Work done to an existing road which restores it to its original design.

Roadway - The portion of a road within limits of construction. Usually from the toe of the fill slope to a point where the cut slope intersects natural ground line.  
Synonym - road prism.

Scale - In quarrying, consists of the removal of loose or overhanging rock adhering to the solid face after a shot or a round of shots has been fired.

Scarification - The process of loosening or breaking up of the surface layer of soil or road, usually to a specified depth.

Separation - Function of geotextile material as a partition between adjacent materials to prevent mixing of those materials.

Shoulder - The portion of the roadbed contiguous with the traveled way designed for accommodation of stopped vehicles, safety, and lateral support of base and surface courses.

Slope ratio notation (horizontal:vertical) - Slope ratios for constructed cut and fill slopes are expressed as a ratio of horizontal units to vertical units.



Spalls - Flakes or chips of stone.

Specifications - A general term applied to all directions, provisions, and requirements pertaining to performance of the work.

Specific Gravity - The ratio of the density of a material to the density of water obtained by weighing known volumes of both items in air. A specific gravity less than one implies that the material will float.

Structures - Bridges, culverts, catch basins, retaining walls, underdrains, flumes, splash pads, downspouts, and other project features which may be involved in the work and not otherwise classified in these specifications.

Sub-base - Reinforcement of the subgrade with large particles of pit-run rock or crushed stone. Usually confined to roads having wet subgrades or subgrades with weak support characteristics.

Surface Course - Top layer of a road structure consisting of finely crushed gravels or asphalt designed to provide a smooth running surface for traffic load.

Subgrade - The top surface of a roadbed upon which the traveled way and shoulders are constructed.

Tensile Strength - The strength shown by a geotextile material subjected to tension as distinct from torsion, compression, or shear.

Tensile Stress - Strain Modulus - A measure of the resistance to elongation under stress. The ratio of the change in tensile stress to the corresponding change in strain.

Tensile Test - A test which subjects geotextile material to tensile forces and measures resultant stresses and strains.

Timber - Standing trees, downed trees, or logs which can be measured in board feet.

Traveled Way - The portion of the roadbed used for the movement of vehicles, exclusive of shoulders.

Typical Cross Sections - Cross-sectional plane of a typical roadway; showing natural ground line and designed roadway in relation to cut and fill, through cut, and through fill.

Turnout - Extra widening of the roadbed at appropriate intervals on single-lane roads for passing purposes.

Ultraviolet (UV) Radiation Stability - The ability of geotextile material to resist deterioration from exposure to sunlight.

Woven Geotextile Material - A textile structure comprising two or more sets of filaments of yarns interlaced in such a way that the elements pass each other at essentially right angles with one set of elements parallel to the geotextile material axis.

102a - Tests Used in These Specifications:

<u>AASHTO T 11</u>	Quantity of rock finer than No. 200 sieve.
<u>AASHTO T 27</u>	Sieve analysis of fine and coarse aggregate using sieves with square openings; gradation.
<u>AASHTO T 89</u>	Liquid limit of material passing the No. 40 sieve. Water content at which the soil passes from a plastic to a liquid state.
<u>AASHTO T 90</u>	Plastic limits and plasticity index of soil. a. Plastic limit - lowest water content at which the soil remains plastic. b. Plasticity index - range of water content, within which the material is in a plastic state. Numerical difference between the liquid and plastic limits of the soil.
<u>AASHTO T 96</u>	Resistance to abrasion of small size coarse aggregate by use of the Los Angeles machine.
<u>AASHTO T 99</u>	Relationship between soil moisture and density of soil. Method A - 4" mold, soil passing a No. 4 sieve 25 blows/layer & 3 layers. Method C - 4" mold, soil passing a 3/4 inch sieve 25 blows/layer & 3 layers. Method D - 6" mold, soil passing a 3/4 inch sieve. 56 blows/layer & 3 layers.
<u>AASHTO T 119</u>	Slump of hydraulic cement concrete.
<u>AASHTO T 152</u>	Air content of freshly mixed concrete.
<u>AASHTO T 166</u>	Specific Gravity of compacted Bituminous Mixtures.
<u>AASHTO T 176</u>	Shows relative portions of fine dust or claylike materials in soil or graded aggregate.
<u>AASHTO T 180</u>	(OSHD 106-71) moisture density relationship of soil same as AASHTO T 99 proctor but uses a 10-lb rammer & 18-in drop height.

<u>AASHTO T 191</u>	<u>Sand Cone.</u> Density of soil in place: For subgrade use 6-inch or 12-inch cone. For rock surfacing for 1-1/2-inch minus to 3-inch minus use 12-inch cone.
<u>AASHTO T 205</u>	<u>Rubber balloon.</u> Density of soil in place. Use for compacted or firmly bonded soil.
<u>AASHTO T 209</u>	Maximum Specific Gravity of Bituminous Paving Mixtures.
<u>AASHTO T 210</u>	Durability of aggregates based on resistance to produce fines.
<u>AASHTO T 224</u>	Correction for coarse particles in the soil.
<u>AASHTO T 238</u>	Density of Soil and Soil-Aggregate in place by nuclear methods.
<u>AASHTO T 248</u>	Reducing field samples of aggregate to testing size by mechanical splitter, quartering, or miniature stockpile sampling.
<u>ASTM D 4564</u>	Determination of relative density of cohesion less soils.
<u>DMSO (dimethyl sulfide)</u>	Determines volume of expanding clays in aggregates. Usually associated with marine basalts.

103 - Compaction equipment shall meet the following requirements:

103b - Sheepsfoot/Tamping rollers. A tamping roller unit shall consist of two (2) watertight metal drums mounted in frames in such manner as to be fully oscillating, together with a tractor having sufficient weight and power under actual working conditions to pull the roller drums at a minimum speed of two and a half (2.5) miles per hour. The drums shall be no less than sixty (60) inches in diameter and no less than fifty-four (54) inches in length, measured at the drum's surface, and shall be studded with tamping feet projecting not less than seven (7) inches from the face of the drums.

The distance between circumferential rows of tamper feet shall be such that the diagonal distance from any foot to the nearest foot in each adjacent row shall be not more than twelve (12) inches. The cross-sectional area of the face of each tamper foot, measured perpendicular to the axis of the stud, shall be not less than 5-1/2 square inches nor more than eight (8) square inches.

The weight of the tamping-roller unit shall be such as to exert a minimum pressure of two hundred fifty (250) pounds per square inch on the ground area in contact with the tamping feet, and the roller shall be so designed that the weight

may be increased to exert a pressure up to five hundred (500) pounds per square inch on the ground area in contact with the tamping feet.

The ground pressure shall be determined by dividing the total weight of the roller unit, not including the weight of the tractor, by the total cross-sectional area of the tamping feet in one (1) row of tamping feet parallel to the axis of the roller.

- 103f - Vibratory roller. The drum diameter shall be not less than forty-eight (48) inches, the drum width not less than fifty-eight (58) inches, and have a turning radius of fifteen (15) feet or less. Vibration frequency shall be regulated in steps to 1400, 1500, and 1600 vibrations per minute (VPM), corresponding to engine speeds of 1575, 1690, and 1800 RPM. The centrifugal force developed shall be seven (7) tons at 1600 RPM. It shall be activated by a power unit of not less than twenty-five (25) horsepower. The vibratory roller shall be self-propelled or drawn by a vehicle of sufficient horsepower to enable the unit to travel through a loose layer of material at a speed ranging from 0.9 mile to 1.8 miles per hour, as directed by the Authorized Officer.

The towing vehicle and roller or self-propelled unit meeting the above requirements shall be considered a vibratory roller unit.

- 103g - Vibratory compactor. Vibratory compactors shall consist of multiple or gang-type compacting units or pads with a minimum variable width of two (2) feet. It shall be self-contained and capable of compacting material as required.
- 103h - Drum drive self-propelled vibratory grid roller. The unit shall consist of one cylindrical drum with a drum diameter of not less than fifty-six (56) inches, nor shall be more than sixty-six (66) inches and the drum width be eighty-four (84) inches. Vibration frequency shall be regulated in steps from 1200 to 1800 vibrations per minute (VPM), and the centrifugal force developed shall be at least 40,000 pounds at 1800 RPM. The vibratory grid roller shall be self-propelled and have a power unit of not less than 112 horsepower. The "grid" design shall be a herringbone or z-bar pattern around the circumference of the drum. The grid bars shall be one (1) inch in height and spaced not more than eight and one half (8-1/2) inches apart.
- 103i - Other. Compaction equipment approved by the Authorized Officer.

Road Number	Start Station or Milepost	End Station or Milepost	Total Length	Typical Cross Section	Min. Curve Radius	ROAD WIDTH		GRADIANT		SURFACING (*5)										Remarks		
						Subgrade	Ditch	Max. Favorable	Max. Adverse	BASE COURSE					SURFACE COURSE							
										Min. Width	Comp. Depth	Surface Type (*3)	Grading Size (*3)	Number of Lifts	Min. Width	Comp. Depth	Surface Type (*3)	Grading Size (*3)	Number of Lifts			
2-5-10.0 (Turner Creek Rd)	0.000	7.647	7.647	6		16'	2'															Renovation. Spread 500 CY 1-1/2"-0" Crushed Spot Rock as marked and needed. Spread 250 CY 4"-0" Crushed Base Rock as marked and needed. Place 175 CY 1-1/2"-0" Crushed Bedding/Backfill Rock as marked. Spread 110 CY Pit-Run to line ditchlines as marked. Place 20 CY Class 5 RipRap as fill armor for channel excavation at MP 3.999. Place 40 CY Class 5 RipRap @ culvert outlet as fill armor/dissipater @ MP 4.370. Re-establish ditchline and haul material to WA as directed. Catch basin is too deep @ MP 2.418, 2.542, 2.648, and 3.733 fix with compacted native soil. Construct and Surface 2 turnouts as marked. Construct ditchouts as marked and needed. Install 23 Sediment Catch Basins with Straw Bales as marked. Excavate a 25' long, 15' wide, and 3' deep channel with 70 SY of woven geosynthetic fabric placed within channel to stop water from going subsurface @ MP 3.999. Replace 2 culverts. Install 6 culverts. Install 55 inlet markers and replace 1 inlet marker.
2-5-29.1 (Fairchild Road)	0.000	2.375	2.375	6		14'	2'															Renovation. Spread a 6" Lift 1-1/2"-0" Crushed Cap Rock over Base Rock (approx. 4,216 CY 1-1/2"-0" Crushed Rock) as directed. Spread 180 CY 1-1/2"-0" Crushed Spot Rock as marked. Spread 440 CY 4"-0" Crushed Base rock as marked. Place 80 CY 1-1/2"-0" Crushed Bedding/Backfill Rock as marked. Spread 90 CY Pit-Run to line ditchlines as marked. Place 20 CY Class 5 RipRap @ outlet as fill armor/dissipater @ MP 1.116. Place 20 CY Class 5 RipRap @ inlet as fill armor to widen road to the right @ MP 1.852. Widen road to the left with suitable native material to allow trucks to make turn. Widen into cutbank approximately 6' for road width and horizontal alignment between MP 1.567 - 1.594 as directed. Re-establish ditchline and haul material to WA as directed. Catch basin is too deep @ MP 0.805 fix with compacted native soil. Excavate catch basin @ MP 1.695. Remove existing slash piles on fill slope between MP 1.116 - 1.122 as directed. Construct Waste Areas as marked and needed. Construct and Surface turnarounds and turnouts as marked. Construct ditchouts and lead-off ditches as marked and needed. Install 14 Sediment Catch Basins with Straw Bales as marked. Replace 1 culvert and re-install 2 downspouts. Install 4 culverts and 3 downspouts. Install 33 inlet markers and replace 1 inlet marker.
2-6-3.0	0.000	0.729	0.729	6		14'	2'															Renovation. Spread 400 CY 1-1/2"-0" Crushed Spot Rock as marked and needed. Spread 80 CY 4"-0" Crushed Base Rock as marked and needed. Re-establish ditchline and haul material to WA as directed. Fix buried inlet and outlet @ MP 0.006. Construct ditchouts as marked and needed. Construct and Surface 1 turnout @ MP 0.463. Install 9 inlet markers.
2-6-9.1	0.000	0.646	0.646	6		14'	2'															Renovation. Spread 380 CY 1-1/2"-0" Crushed Spot Rock as marked and needed. Spread 140 CY 4"-0" Crushed Base Rock as marked and needed. Place 40 CY 1-1/2" Crushed Bedding/Backfill Rock as marked. Spread 15 CY Pit-Run to line ditchline between MP 0.338 - 0.354. Place 20 CY Class 5 RipRap @ outlet as fill armor/dissipater @ MP 0.338 and 0.354. Place 10 CY Class 5 RipRap @ MP 0.341 to form rock wall and direct water drainage. Place 10 CY Class 5 by hand @ outlet as dissipater @ MP 0.606. Re-establish ditchline and haul material to WA as directed. Construct and Surface 2 turnouts as marked. Construct ditchouts as marked and needed. Install 4 Sediment Catch Basins with Straw Bales as marked. Install 2 culverts and install 1 downspout. Re-install 1 downspout. Install 8 inlet markers and replace 1 inlet marker.
	0.646	0.847	0.201	6		14'	2'															Renovation. Spread a 6" Lift 1-1/2"-0" Crushed Cap Rock over Base Rock (approx. 390 CY 1-1/2"-0" Crushed Rock) as directed. Re-establish ditchline and haul material to WA as directed. Construct a Stockpile Site/Waste Area at MP 0.825 as directed. Install 2 inlet markers.
	0.847	0.855	0.008	6		14'	2'															Renovation. Spread 40 CY 1-1/2"-0" Crushed Spot Rock as needed. Spread 10 CY 4"-0" Crushed Base Rock as needed. Re-establish ditchline and haul material to WA as directed.
	0.855	0.872	0.017	4		14'	0'															Renovation. Spread 80 CY 1-1/2"-0" Crushed Spot Rock as marked and needed. Spread 50 CY 4"-0" Crushed Base Rock as marked and needed. Place 40 CY 1-1/2"-0" Crushed Bedding/Backfill Rock as marked. Grade out cracks in subgrade between MP 0.855 - 0.868 as directed. Salvage 10' of existing 24" CPP @ MP 0.855. Install 1 culvert. Replace 1 culvert. Install 2 inlet markers.
2-6-10.1	0+00	17+63	17+63	6		14'	2'	18%	18%	13'	8"	ABC	D	2	12'	4"	ASC	C				New Construct. Spread a 4" Lift 1-1/2"-0" Crushed Cap Rock over Base Rock (approx. 391 CY 1-1/2"-0" Crushed Rock) as directed. Spread an 8" Lift 4"-0" Crushed Base Rock (approx. 844 CY 4"-0" Crushed Base Rock) as directed. Spread 70 CY 1-1/2"-0" Crushed Spot Rock as marked. Spread 130 CY 4"-0" Crushed Base Rock as marked. Place 80 CY 1-1/2"-0" Crushed Bedding/Backfill Rock as marked. Fill to achieve desired grade between Sta. 0+88 - 2+63 using fill from 2-6-11.0 (Sta. 23+80 - 26+70) as directed. Cut and drift material between Sta. 2+63 - 3+48 and use as fill as directed. Cut and drift material between 9+10 - 11+69 and use as fill between 11+69 - 12+85 as directed. Construct turnout and turnarounds as marked. Construct ditchouts as marked and needed. Construct a Landing (approx. 50' diameter) as marked. Install 5 culverts. Install inlet markers.
2-6-10.2	0+00	1+62	1+62	4		14'	0'	10%	10%	13'	8"	ABC	D	2	12'	4"	ASC	C				New Construct. Spread a 4" Lift 1-1/2"-0" Crushed Cap Rock over Base Rock (approx. 34 CY 1-1/2"-0" Crushed Rock) as directed. Spread an 8" Lift 4"-0" Crushed Base Rock (approx. 74 CY 4"-0" Crushed Base Rock) as directed. Spread 40 CY 1-1/2"-0" Crushed Spot Rock as marked. Spread 70 CY 4"-0" Crushed Base Rock as marked. Construct a Landing (approx. 50' diameter) as marked.
2-6-10.3	0+00	4+38	4+38	6		14'	2'	18%	18%	13'	8"	ABC	D	2	12'	4"	ASC	C				New Construct. Spread a 4" Lift 1-1/2"-0" Crushed Cap Rock over Base Rock (approx. 94 CY 1-1/2"-0" Crushed Rock) as directed. Spread an 8" Lift 4"-0" Crushed Base Rock (approx. 204 CY 4"-0" Crushed Base Rock) as directed. Spread 40 CY 1-1/2"-0" Crushed Spot Rock as marked. Spread 70 CY 4"-0" Crushed Base Rock as marked. Place 20 CY 1-1/2"-0" Crushed Bedding/Backfill Rock. Place 330 CY Class 5 RipRap between 1+30 - 2+32 on fill slope for stabilization wall. Cut and Drift material between 0+77 - 3+12 and use as fill to achieve desired grade. Excavate material at Sta. 1+30 to use as fill at landing (Sta. 4+38). Construct ditchout as marked and needed. Construct a Landing (approx. 50' diameter) as marked. Install 1 culvert. Install 1 inlet marker.

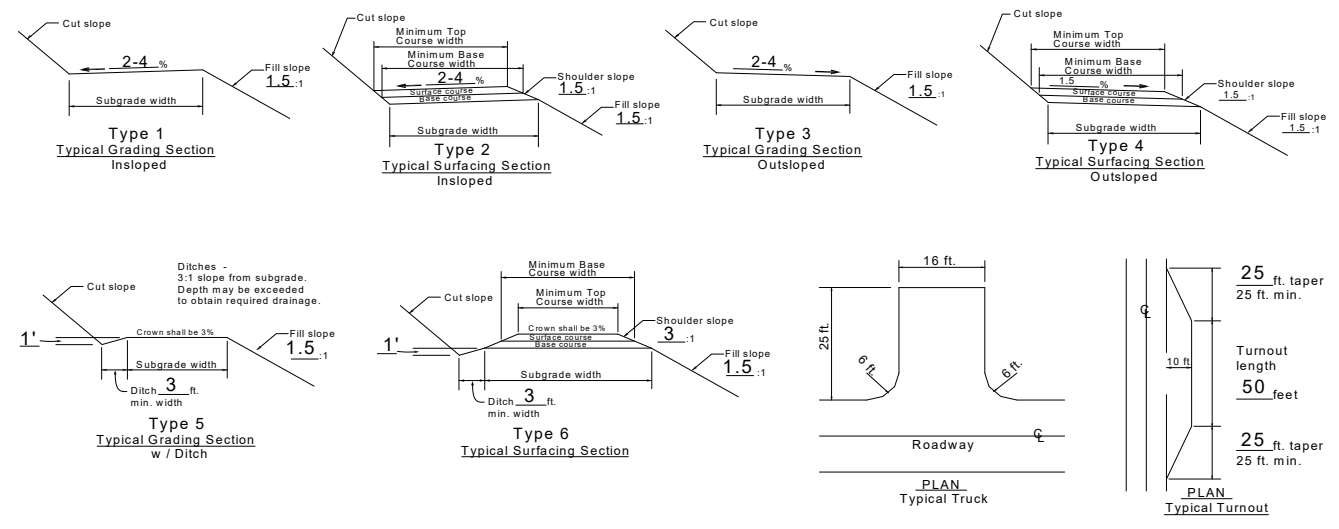

- \*NOTES**
- Extra subgrade widths**  
Add to each shoulder: 1 ft. for fills of 1-6 ft. and 2 ft. for fills over 6 ft. Widen the inside shoulder of curves as follows:  
(See Road Plan Map, Exhibit C)
  - Backslopes**  
Materials      Cut slopes      Fill slopes  
Solid rock      1/4:1      Angle of repose  
Soft rock and shale      1/2:1  
Common  
Slopes under 55%      1:1      1-1/2:1  
Slopes over 55%      3/4:1      1-1/2:1
  - Surface type**  
PRR - Pit run rock      Grading  
GRR - Grid rolled rock      A - 3"      (base course)  
SRN - Screened rock      B - 2"      (base course)  
JRR - Jaw run rock      C - 3" jaw run  
ABC - Aggr. base course      D - 4" jaw run  
ASC - Aggr. surface course      C - 1-1/2"      (surface course)  
WC - Wood chips      D - 1"      (surface course)  
E - 3/4"
  - Turnouts**  
Width - 10 ft. in addition to subgrade width, or as shown on the plans.  
Located approximately as shown on the plans.  
Intervisible and not more than 750 ft. apart.
  - Surfacing**  
Turnouts, curve widening and road approach aprons shall be surfaced.
  - Clearing width**      200  
See Section 200
  - As posted and painted for Right-of-Way:
  - Drainage**  
See Culvert List
  - Compaction**      300 and 400  
See Sections 300 and 400
- Note: Full bench construction is required on side slopes exceeding 60%.
- \*Clearing Limits as posted on ground

U.S. DEPT. OF THE INTERIOR  
Bureau of Land Management  
NORTHWEST OREGON DISTRICT OFFICE - OREGON  
**150: ROAD PLAN AND DETAIL SHEET**

Road Number	Start Station or Milepost	End Station or Milepost	Total Length	Typical Cross Section	Min. Curve Radius	ROAD WIDTH		GRADIENT		SURFACING (*5)										Remarks
						Subgrade	Ditch	Max. Favorable	Max. Adverse	BASE COURSE					SURFACE COURSE					
										Min. Width	Comp. Depth	Surface Type (*3)	Grading Size (*3)	Number of Lifts	Min. Width	Comp. Depth	Surface Type (*3)	Grading Size (*3)	Number of Lifts	
2-6-11.0	0+00	15+43	15+43	6		14'	2'			13'	6"	ABC	D	2	12'	4"	ASC	C	1	Renovation. Spread a 4" Lift 1-1/2"-0" Crushed Cap Rock over Base Rock (approx. 350 CY 1-1/2"-0" Crushed Rock) as directed. Spread a 6" Lift 4"-0" Crushed Base Rock (approx. 534 CY 4"-0" Crushed Base Rock) as directed. Spread 30 CY 1-1/2"-0" Crushed Spot Rock as marked. Spread 60 CY 4"-0" Crushed Base Rock as marked. Re-establish ditchline and haul material to WA as directed. Construct ditchouts as marked and needed. Construct and Surface turnout and turnaround as marked.
	15+43	44+13	28+70	6		14'	2'			13'	8"	ABC	D	2	12'	4"	ASC	C	1	Renovation. Spread a 4" Lift 1-1/2"-0" Crushed Cap Rock over Base Rock (approx. 649 CY 1-1/2"-0" Crushed Rock) as directed. Spread an 8" Lift 4"-0" Crushed Base Rock (approx. 1,338 CY 4"-0" Crushed Base Rock) as directed. Spread 30 CY 1-1/2"-0" Crushed Spot Rock as marked. Spread 60 CY 4"-0" Crushed Base Rock as marked. Place 60 CY 1-1/2"-0" Crushed Bedding/Backfill Rock as marked. Re-establish ditchline and haul material to WA as directed. Cut and drift material between Sta. 17+73 - 19+98 and use as fill material between Sta. 19+98 - 21+60. Cut and drift material between Sta. 23+80 - 26+70 and use as fill material on 2-6-10.1 between Sta. 0+88 - 2+63. Construct ditchouts and lead-off ditches as marked and needed. Construct waste areas as marked and needed. Construct and Surface turnout and turnarounds as marked. Remove existing waterbars as marked and needed. Install 3 culverts. Install 3 inlet markers.
	44+13	45+79	1+66	6		14'	2'			13'	8"	ABC	D	2	12'	4"	ASC	C	1	Improvement. Spread a 4" Lift 1-1/2"-0" Crushed Cap Rock over Base Rock (approx. 35 CY 1-1/2"-0" Crushed Rock) as directed. Spread an 8" Lift 4"-0" Crushed Base Rock (approx. 75 CY 4"-0" Crushed Base Rock) as directed. Spread 60 CY 1-1/2"-0" Crushed Spot Rock as marked. Spread 100 CY 4"-0" Crushed Base Rock as marked. Place 10 CY 1-1/2"-0" Crushed Bedding/Backfill Rock as marked. Re-establish ditchline and haul material to WA as directed. Construct a Landing (approx. 50' diameter) as marked. Install 1 Culvert.
2-6-11.1	0+00	4+33	4+33	6		14'	2'	18%	18%	13'	8"	ABC	D	2	12'	4"	ASC	C	1	New Construct. Spread a 4" Lift 1-1/2"-0" Crushed Cap Rock over Base Rock (approx. 93 CY 1-1/2"-0" Crushed Rock) as directed. Spread an 8" Lift 4"-0" Crushed Base Rock (approx. 202 CY 4"-0" Crushed Base Rock) as directed. Spread 20 CY 1-1/2"-0" Crushed Spot Rock as marked. Spread 40 CY 4"-0" Crushed Base Rock as marked. Place 20 CY 1-1/2"0" Crushed Bedding/Backfill Rock. Construct and Surface turnaround as marked. Construct waste area as marked and needed. Construct lead-off ditch as marked. Excavate and create a smooth transition @ Sta. 4+20. Install 1 culvert. Install 1 inlet marker.
	4+33	42+80	38+47	6		14'	2'			13'	8"	ABC	D	2	12'	4"	ASC	C	1	Renovation. Spread a 4" Lift 1-1/2"-0" Crushed Cap Rock over Base Rock (approx. 837 CY 1-1/2"-0" Crushed Rock) as directed. Spread an 8" Lift 4"-0" Crushed Base Rock (approx. 1,808 CY 4"-0" Crushed Base Rock) as directed. Spread 80 CY 1-1/2"-0" Crushed Spot Rock as marked. Spread 150 CY 4"-0" Crushed Base Rock as marked. Place 270 CY 1-1/2"-0" Crushed Bedding/Backfill Rock as marked. Place 140 CY Class 5 RipRap to the left and 60 CY Class 5 RipRap to the right between Sta. 9+51 - 10+25 for fill armor/stabilization wall as directed. Place 30 CY Class 5 RipRap @ inlet as fill armor and 65 CY Class 5 RipRap @ outlet for fill armor/dissipater at Sta. 17+51. Place 10 CY Class 5 RipRap @ inlet as fill armor and 40 CY Class 5 RipRap @ outlet as fill armor/dissipater at Sta. 18+69. Place 100 CY Class 5 RipRap on fill slope as fill armor at Sta. 31+78. Place 10 CY Class 5 RipRap @ inlet as fill armor and 30 CY Class 5 RipRap @ outlet as fill armor/dissipater at Sta. 34+33. Place 150 CY 1-1/2"-3/4" Crushed Drain Rock wrapped with 200 SY of non-woven geo-synthetic fabric to construct a free-draining fill at Sta. 31+78. Cut and drift material between Sta. 6+69 - 9+51 and use as fill material between Sta. 9+51 - 10+25. Shift centerline to the left to achieve desired horizontal alignment as marked. Excavate into cut bank between Sta. 10+49 - 11+75 to widen road as directed. Excavate into cut bank and use as fill between Sta. 25+70 - 27+02 to widen road as directed. Excavate a stream channel from the culvert inlet up the hill to the existing road to divert stream into newly excavated stream bed at Sta. 18+69. Re-establish ditchline and haul material to WA as directed. Construct ditchouts as marked and needed. Construct and Surface turnouts and turnarounds as marked. Construct waste areas as marked and needed. Install 4 Sediment Catch Basin with Straw Bales as marked. Construct a Landing (approx. 40' diameter) as marked. Install 11 culverts and 2 downspouts. Replace 1 culvert. Install 12 inlet markers.
2-6-11.2	0+00	2+73	2+73	6		14'	2'	18%	18%	13'	8"	ABC	D	2	12'	4"	ASC	C	1	New Construct. Spread a 4" Lift 1-1/2"-0" Crushed Cap Rock over Base Rock (approx. 58 CY 1-1/2"-0" Crushed Rock) as directed. Spread an 8" Lift 4"-0" Crushed Base Rock (approx. 125 CY 4"-0" Crushed Base Rock) as directed. Spread 20 CY 1-1/2"-0" Crushed Spot Rock as marked. Spread 40 CY 4"-0" Crushed Base Rock as marked. Place 20 CY 1-1/2"-0" Crushed Bedding/Backfill Rock as marked. Construct and Surface turnaround at Sta. 2+73. Construct waste area at Sta. 2+73. Install 1 culvert.
	2+73	4+49	1+76	4		14'	0'	18%	18%	13'	8"	ABC	D	2	12'	4"	ASC	C	1	New Construct. Spread a 4" Lift 1-1/2"-0" Crushed Cap Rock over Base Rock (approx. 37 CY 1-1/2"-0" Crushed Rock) as directed. Spread an 8" Lift 4"-0" Crushed Base Rock (approx. 80 CY 4"-0" Crushed Base Rock) as directed. Spread 30 CY 1-1/2"-0" Crushed Spot Rock as marked. Spread 50 CY 4"-0" Crushed Base Rock as marked. Construct a Landing (approx. 50' diameter) as marked.
2-6-11.3	0+00	2+83	2+83	4		14'	0'	12%	12%	13'	8"	ABC	D	2	12'	4"	ASC	C	1	New Construct. Spread a 4" Lift 1-1/2"-0" Crushed Cap Rock over Base Rock (approx. 61 CY 1-1/2"-0" Crushed Rock) as directed. Spread an 8" Lift 4"-0" Crushed Base Rock (approx. 132 CY 4"-0" Crushed Base Rock) as directed. Spread 50 CY 1-1/2"-0" Crushed Spot Rock as marked. Spread 90 CY 4"-0" Crushed Base Rock as marked. Construct and Surface turnaround at Sta. 2+07. Construct a Landing (approx. 50' diameter) as marked.

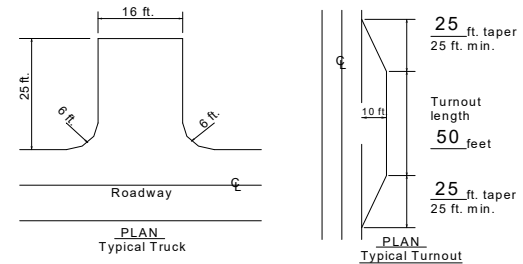
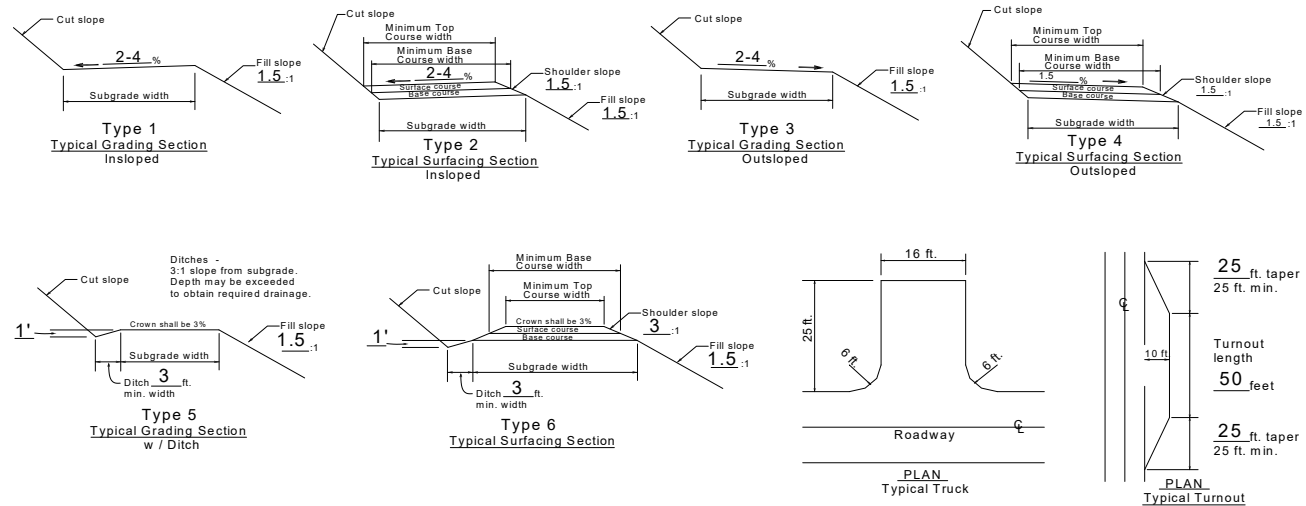

**\*NOTES**

- Extra subgrade widths**  
Add to each shoulder: 1 ft. for fills of 1-6 ft. and 2 ft. for fills over 6 ft. Widen the inside shoulder of curves as follows:  
(See Road Plan Map, Exhibit C)
- Backslopes**  
Materials      Cut slopes      Fill slopes  
Solid rock      1/4:1      Angle of repose  
Soft rock and shale      1/2:1  
Common  
Slopes under 55%      1:1      1-1/2:1  
Slopes over 55%      3/4:1      1-1/2:1
- Surface type**  
PRR - Pit run rock      Grading  
GRR - Grid rolled rock      A - 3"  
SRN - Screened rock      B - 2" (base course)  
JRR - Jaw run rock      C - 3" jaw run (base course)  
ABC - Aggr. base course      D - 4" jaw run  
ASC - Aggr. surface course      C - 1-1/2"  
WC - Wood chips      D - 1" (surface course)  
E - 3/4"
- Turnouts**  
Width - 10 ft. in addition to subgrade width, or as shown on the plans. Located approximately as shown on the plans. Intervisible and not more than 750 ft. apart.
- Surfacing**  
Turnouts, curve widening and road approach aprons shall be surfaced.
- Clearing width** 200  
See Section
- As posted and painted for Right-of-Way:
- Drainage**  
See Culvert List
- Compaction** 300 and 400  
See Sections

\*Clearing Limits as posted on ground

Road Number	Start Station or Milepost	End Station or Milepost	Total Length	Typical Cross Section	Min. Curve Radius	ROAD WIDTH		GRADIANT		SURFACING (*5)											Remarks
						Subgrade	Ditch	Max. Favorable	Max. Adverse	BASE COURSE					SURFACE COURSE						
										Min. Width	Comp. Depth	Surface Type (*3)	Grading Size (*3)	Number of Lifts	Min. Width	Comp. Depth	Surface Type (*3)	Grading Size (*3)	Number of Lifts		
2-6-12.1	0.000	0.710	0.710	6	14'	2'															Renovation. Spread 400 CY 1-1/2"-0" Crushed Spot Rock as marked and needed. Spread 200 CY 4"-0" Crushed Base Rock as marked and needed. Place 65 CY 1-1/2"-0" Crushed Bedding/Backfill Rock as marked. Re-establish ditchline and haul material to WA as directed. Wrap ditch from 2-5-10.0 into existing ditchline of 2-6-12.1 at MP 0.000. Wrap ditch from 2-6-12.1 into existing ditchline of 2-5-29.1 at MP 0.710. Construct ditchouts and lead-off ditch as marked and needed. Construct and Surface turnouts as marked. Install 2 culverts and replace 1 culvert. Install 5 inlet markers.
2-6-14.0	0+00	22+75	22+75	6	14'	2'															Renovation. Spread 310 CY 1-1/2"-0" Crushed Spot Rock as marked and needed. Spread 160 CY 4"-0" Crushed Base Rock as marked and needed. Place 35 CY 1-1/2"-0" Crushed Bedding/Backfill Rock as marked. Place 5 CY Class 5 RipRap @ inlet for fill armor at Sta. 12+45. Re-establish ditchline and haul material to WA as directed. Clean catch basin from native material at Sta. 4+40. Construct ditchouts and lead-off ditches as marked and needed. Remove existing waste pile (woody debris) @ outlet at Sta. 16+46. Excavate large boulders from cut bank between 17+00 - 19+50 to achieve desired cut slope and road width. Construct and Surface turnout at Sta. 3+72. Install 2 culverts and 1 downspout. Install 4 inlet markers.
2-6-14.1	0+00	2+06	2+06	6	14'	2'				13'	8"	ABC	D	2	12'	4"	ASC	C	1		Improvement. Spread a 4" Lift 1-1/2"-0" Crushed Cap Rock over Base Rock (approx. 45 CY 1-1/2"-0" Crushed Rock) as directed. Spread an 8" Lift 4"-0" Crushed Base Rock (approx. 97 CY 4"-0" Crushed Base Rock) as directed. Spread 30 CY 1-1/2"-0" Crushed Spot Rock as marked. Spread 20 CY 4"-0" Crushed Base Rock as marked. Re-establish ditchline and haul material to WA as directed. Cut and drift material between Sta. 1+54 - 2+05 to use as fill as directed. Excavate material to create smooth transition between Sta. 1+54 - 2+05 at 2-6-14.1 and 2-6-15.4 junction.
2-6-14.2	0+00	17+80	17+80	6	14'	2'				13'	6"	ABC	D	2	12'	4"	ASC	C	1		Renovation. Spread a 4" Lift 1-1/2"-0" Crushed Cap Rock over Base Rock (approx. 376 CY 1-1/2"-0" Crushed Rock) as directed. Spread a 6" Lift 4"-0" Crushed Base Rock (approx. 610 CY 4"-0" Crushed Base Rock) as directed. Spread 30 CY 1-1/2"-0" Crushed Spot Rock as marked. Spread 60 CY 4"-0" Crushed Base Rock as marked. Spread 30 CY PitRun between 3+42 - 5+22 to line ditchline. Re-establish ditchline and haul material to WA as directed. Construct ditchouts as marked and needed. Construct and Surface turnouts and turnaround as marked. Construct waste area as marked and directed. Install 1 inlet marker.
	17+80	21+67	3+87	6	14'	2'	18%	18%		13'	8"	ABC	D	2	12'	4"	ASC	C	1		New Construct. Spread a 4" Lift 1-1/2"-0" Crushed Cap Rock over Base Rock (approx. 82 CY 1-1/2"-0" Crushed Rock) as directed. Spread an 8" Lift 4"-0" Crushed Base Rock (approx. 177 CY 4"-0" Crushed Base Rock) as directed. Spread 50 CY 1-1/2"-0" Crushed Spot Rock as marked. Spread 90 CY 4"-0" Crushed Base Rock as marked. Place 20 CY 1-1/2"-0" Crushed Bedding/Backfill Rock. Construct ditchouts as marked and needed. Construct and Surface turnaround at Sta. 18+18. Construct a Landing (approx. 50' diameter) as directed. Install 1 culvert. Install 1 inlet marker.
2-6-14.3	0+00	12+16	12+16	6	14'	2'				13'	8"	ABC	D	2	12'	4"	ASC	C	1		Renovation. Spread a 4" Lift 1-1/2"-0" Crushed Cap Rock over Base Rock (approx. 262 CY 1-1/2"-0" Crushed Rock) as directed. Spread an 8" Lift 4"-0" Crushed Base Rock (approx. 566 CY 4"-0" Crushed Base Rock) as directed. Spread 60 CY 1-1/2"-0" Crushed Spot Rock as marked. Spread 110 CY 4"-0" Crushed Base Rock as marked. Place 85 CY 1-1/2"-0" Crushed Bedding/Backfill Rock as marked. Place 170 CY Class 5 RipRap on fill slope between Sta. 1+50 - 2+63 for fill armor as marked. Place 10 CY Class 5 RipRap @ outlet as fill armor at Sta. 11+51 as marked. Shift centerline to the right 5' between Sta. 1+50 - 2+63 as marked. Construct and Surface turnout and turnaround as marked. Construct a Landing (approx. 50' diameter) as marked. Install 5 culverts and 1 downspout. Install 4 inlet markers.
2-6-14.4	0+00	10+64	10+64	6	14'	2'				13'	6"	ABC	D	2	12'	4"	ASC	C	1		Renovation. Spread a 4" Lift 1-1/2"-0" Crushed Cap Rock over Base Rock (approx. 223 CY 1-1/2"-0" Crushed Rock) as directed. Spread a 6" Lift 4"-0" Crushed Base Rock (approx. 361 CY 4"-0" Crushed Base Rock) as directed. Spread 30 CY 1-1/2"-0" Crushed Spot Rock as marked. Spread 60 CY 4"-0" Crushed Base Rock as marked. Re-establish ditchline and haul material to WA as directed. Remove/Scatter existing waste piles between Sta. 0+00 - 4+47 as directed. Construct ditchouts and lead-off ditches as marked and needed. Construct and Surface turnout/roadside landing as marked. Install 2 inlet markers.

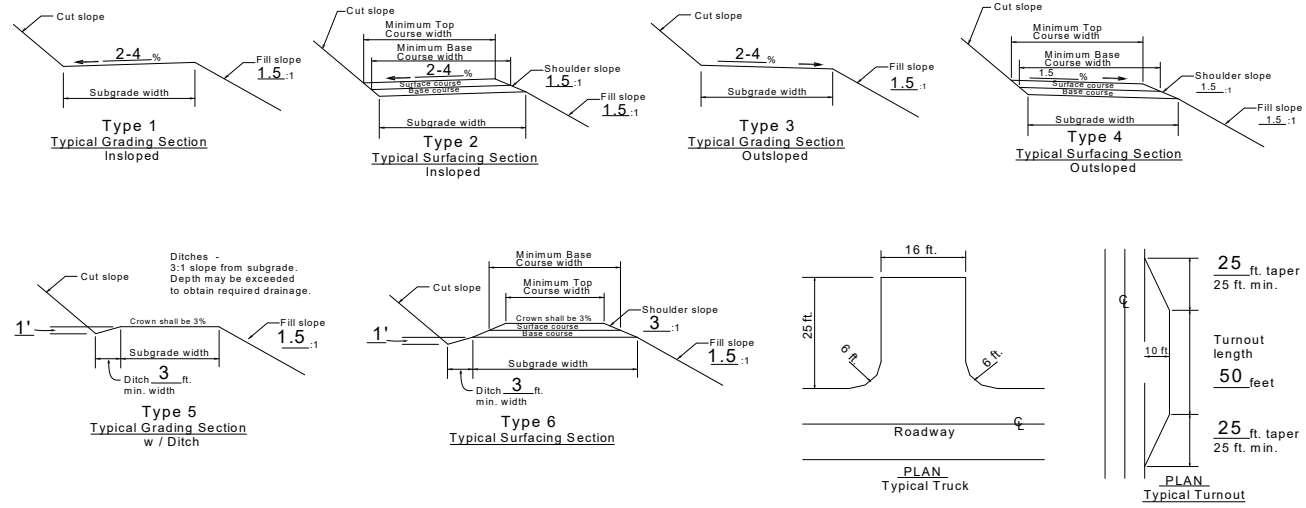

**\*NOTES**

- Extra subgrade widths:** Add to each shoulder: 1 ft. for fills of 1-6 ft. and 2 ft. for fills over 6 ft. Widen the inside shoulder of curves as follows: (See Road Plan Map, Exhibit C)
- Backslopes:**

Materials	Cut slopes	Fill slopes
Solid rock	1/4:1	Angle of repose
Soft rock and shale	1/2:1	
Common		
Slopes under 55%	1:1	1-1/2:1
Slopes over 55%	3/4:1	1-1/2:1
- Surface type:**

	Grading
PRR - Pit run rock	A - 3"
GRR - Grid rolled rock	B - 2"
SRN - Screened rock	C - 3" jaw run (base course)
JRR - Jaw run rock	D - 4" jaw run
ABC - Aggr. base course	C - 1-1/2"
ASC - Aggr. surface course	D - 1"
WC - Wood chips	E - 3/4"
- Turnouts:** Width - 10 ft. in addition to subgrade width, or as shown on the plans. Located approximately as shown on the plans. Intervisible and not more than 750 ft. apart.
- Surfacing:** Turnouts, curve widening and road approach aprons shall be surfaced.
- Clearing width:** 200. See Section.
- As posted and painted for Right-of-Way:**
- Drainage:** See Culvert List
- Compaction:** See Sections 300 and 400

\*Clearing Limits as posted on ground

U.S. DEPT. OF THE INTERIOR  
Bureau of Land Management  
NORTHWEST OREGON DISTRICT OFFICE - OREGON  
**150: ROAD PLAN AND DETAIL SHEET**

Road Number	Start Station or Milepost	End Station or Milepost	Total Length	Typical Cross Section	Min. Curve Radius	ROAD WIDTH		GRADIANT		SURFACING (*5)										Remarks
						Subgrade	Ditch	Max. Favorable	Max. Adverse	Min. Width	Comp. Depth	BASE COURSE			SURFACE COURSE					
												Surface Type (*3)	Grading Size (*3)	Number of Lifts	Min. Width	Comp. Depth	Surface Type (*3)	Grading Size (*3)	Number of Lifts	
2-6-14.5	0+00	1+50	1+50	4		14'	0'	10%	10%	13'	8"	ABC	D	2	12'	4"	ASC	C	1	New Construct. Spread a 4" Lift 1-1/2"-0" Crushed Cap Rock over Base Rock (approx. 31 CY 1-1/2"-0" Crushed Rock) as directed. Spread an 8" Lift 4"-0" Crushed Base Rock (approx. 68 CY 4"-0" Crushed Base Rock) as directed. Spread 40 CY 1-1/2"-0" Crushed Spot Rock as marked. Spread 70 CY 4"-0" Crushed Base Rock as marked. Construct a Landing (approx. 50' diameter) as marked.
2-6-14.6	0+00	3+62	3+62	6		14'	2'	16%	16%	13'	8"	ABC	D	2	12'	4"	ASC	C	1	New Construct. Spread a 4" Lift 1-1/2"-0" Crushed Cap Rock over Base Rock (approx. 78 CY 1-1/2"-0" Crushed Rock) as directed. Spread an 8" Lift 4"-0" Crushed Base Rock (approx. 169 CY 4"-0" Crushed Base Rock) as directed. Spread 40 CY 1-1/2"-0" Crushed Spot Rock as marked. Spread 80 CY 4"-0" Crushed Base Rock as marked. Fill between Sta. 1+13 - 1+71 using material from 2-6-15.4 (Sta. 7+88 - 9+81) as directed. Construct and Surface turnaround at Sta. 1+89. Construct a Landing (approx. 40' diameter) as marked. Install 1 culvert.
2-6-15.4	0+00	7+88	7+88	6		14'	2'	18%	18%	13'	8"	ABC	D	2	12'	4"	ASC	C	1	New Construct. Spread a 4" Lift 1-1/2"-0" Crushed Cap Rock over Base Rock (approx. 175 CY 1-1/2"-0" Crushed Rock) as directed. Spread an 8" Lift 4"-0" Crushed Base Rock (approx. 377 CY 4"-0" Crushed Base Rock) as directed. Spread 10 CY 1-1/2"-0" Crushed Spot Rock as marked. Spread 20 CY 4"-0" Crushed Base Rock as marked. Place 20 CY 1-1/2"-0" Crushed Bedding/Backfill Rock as marked. Place 330 CY Class 5 RipRap between Sta. 0+00 - 1+32 for a stabilization wall/fill armor. Remove existing slash pile at Sta. 0+43 and haul material to WA as directed. Excavate large boulders from cut bank (use as RipRap) between Sta. 5+28 - 5+61 to achieve desired cut slope and road width. Construct ditchouts as marked and needed. Install 1 culvert. Install 1 inlet marker.
	7+88	9+81	1+93	6		14'	2'			13'	8"	ABC	D	2	12'	4"	ASC	C	1	Improvement. Spread a 4" Lift 1-1/2"-0" Crushed Cap Rock over Base Rock (approx. 41 CY 1-1/2"-0" Crushed Rock) as directed. Spread an 8" Lift 4"-0" Crushed Base Rock (approx. 88 CY 4"-0" Crushed Base Rock) as directed. Cut material between Sta. 7+88 - 9+81 and use as fill on 2-6-14.6 between Sta. 1+13 - 1+71 as directed.
	9+81	23+51	13+70	6		14'	2'			13'	8"	ABC	D	2	12'	4"	ASC	C	1	Renovation. Spread a 4" Lift 1-1/2"-0" Crushed Cap Rock over Base Rock (approx. 337 CY 1-1/2"-0" Crushed Rock) as directed. Spread an 8" Lift 4"-0" Crushed Base Rock (approx. 728 CY 4"-0" Crushed Base Rock) as directed. Spread 50 CY 1-1/2"-0" Crushed Spot Rock as marked. Spread 90 CY 4"-0" Crushed Base Rock as marked. Place 10 CY 1-1/2"-0" Crushed Bedding/Backfill Rock as marked. Fill using native material between Sta. 15+89 - 17+42 to achieve desired grade as directed. Fill using native material between Sta. 18+13 - 19+24 to achieve desired grade as directed. Cut and drift material between Sta. 20+31 - 20+64 and use as fill between Sta. 20+64 - 21+27 as directed. Cut and drift material between Sta. 21+27 - 22+28 and use as fill between Sta. 20+64 - 21+27. Construct ditchouts as marked and needed. Construct and Surface turnarounds as marked. Construct a Landing (approx. 50' diameter) as marked. Install 1 culvert and 1 downspout.

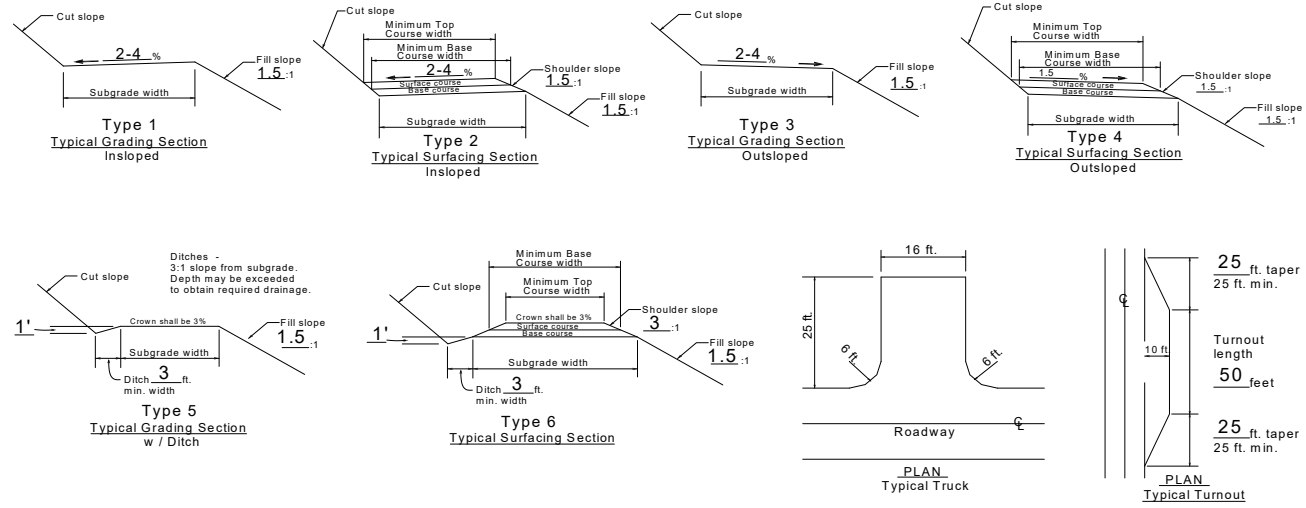

- \*NOTES**
- Extra subgrade widths:** Add to each shoulder: 1 ft. for fills of 1-6 ft. and 2 ft. for fills over 6 ft. Widen the inside shoulder of curves as follows: (See Road Plan Map, Exhibit C)
  - Backslopes:**

Materials	Cut slopes	Fill slopes
Solid rock	1:4:1	Angle of repose
Soft rock and shale	1:2:1	
Common	Slopes under 55% 1:1	1-1/2:1
	Slopes over 55% 3/4:1	1-1/2:1

Note: Full bench construction is required on side slopes exceeding 60%.
  - Surface type:**

Surface type	Grading
PRR - Pit run rock	A - 3"
GRR - Grid rolled rock	B - 2"
SRN - Screened rock	C - 3" jaw run
JRR - Jaw run rock	D - 4" jaw run
ABC - Aggr. base course	C - 1-1/2"
ASC - Aggr. surface course	D - 1"
WC - Wood chips	E - 3/4"
  - Turnouts:** Width - 10 ft. in addition to subgrade width, or as shown on the plans. Located approximately as shown on the plans. Intervisible and not more than 750 ft. apart.
  - Surfacing:** Turnouts, curve widening and road approach aprons shall be surfaced.
  - Clearing width:** See Section 200.
  - As posted and painted for Right-of-Way:**
  - Drainage:** See Culvert List.
  - Compaction:** See Sections 300 and 400.
- \*Clearing Limits as posted on ground**



**CLEARING AND GRUBBING - 200**

- 201 - This work shall consist of clearing, grubbing, removing and disposing of vegetation, debris, surface objects, and protruding obstructions within the clearing limits in accordance with these specifications and conforming to the lines, grades, dimensions and typical cross sections shown on the plans and as marked on the ground.
- 201a - This work shall consist of clearing, grubbing, removing and disposing of vegetation, debris, surface objects, and protruding obstructions from borrow pits, quarries, channel changes, stockpile sites, etc., in accordance with these specifications (and as staked on the ground).
- 202 - Where clearing limits have not been staked, established by these specifications or shown on the plans, the limits shall extend ten (10) feet back of the top of the cut slope and five (5) feet out from the toe of the fill slope.
- 202b - Where clearing limits for channel changes and waste areas have not been staked or shown on the plans, the limits shall extend ten (10) feet back of the top of the cut slope and five (5) feet outside of the outside slope lines.
- 203 - Clearing shall consist of the removal and disposal of trees, logs, rotten material, brush, and other vegetative materials and surface objects in accordance with these specifications and within the limits established for clearing as specified under Subsections 202 and 202b, as shown on the plans, and as marked on the ground.
- 203b - Standing trees and snags to be cleared shall be felled within the limits established for clearing, unless otherwise authorized. Felled snags shall be left as down woody debris outside of the clearing limits.
- 203c - Disposal of logs from private timber cleared within the limits established shall consist of decking at a location designated by the Authorized Officer.
- 204 - Grubbing shall consist of the removal and disposal of stumps, roots, and other wood material embedded in the ground and protruding obstacles remaining as a result of the clearing operation. Undisturbed stumps, roots and other solid objects which will be a minimum of four (4) feet below subgrades or slope surfaces or embankments are excluded.
- 205 - Clearing and grubbing debris shall not be placed or permitted to remain in or under road embankment sections.
- 206a - Notwithstanding Subsections 204 and 205, clearing and grubbing debris resulting from landing construction, waste area construction, turnaround

construction, or log fill replacement shall be placed at disposal sites and shall not be covered with excavated material. Location of disposal sites will be determined by the Authorized Officer.

- 210 - Disposal of (clearing and grubbing debris) (stumps and cull logs) shall be by scattering over government owned lands outside of established clearing limits in a manner acceptable to the Authorized Officer. The areas for such scattering shall have the prior approval of the Authorized Officer.
- 210a - Disposal of clearing and grubbing debris, stumps, and cull logs (on non-government property) shall be by scattering over non-government owned lands outside of established clearing limits in a manner acceptable to the Authorized Officer.
- 213 - No clearing or grubbing debris shall be left lodged against standing trees.

#### **EXCAVATION AND EMBANKMENT - 300**

- 301 - This work shall consist of excavating, overhaul, placement of embankments, backfilling, borrowing, leveling, ditching, grading, outsloping, crowning and scarification of the subgrade, compaction, disposal of excess and unsuitable and slide materials, and other earth-moving work in accordance with these specifications and conforming to the lines, grades, dimensions, and typical cross sections shown on the plans.
- 302 - Excavation shall also consist of the excavation of road and landing cut sections, borrow sites, backfilling, leveling, ditching, grading, compaction, and other earth moving work necessary for the construction of the roadway in accordance with these specifications and conforming to the lines, grades, dimensions, and typical cross sections shown on the plans and as marked on the ground.
- 303 - Suitable material removed from the excavation shall be used in the formation of embankment subgrade, shoulders, slopes, bedding, backfill for structures, and for other purposes as shown on the plans.
- 304 - Borrow shall consist of suitable material required for the construction of embankments or for other portions of the work; such material shall be obtained from sources selected by the Purchaser at his option and approved by the Authorized Officer.
- 305 - Embankment construction shall consist of the placement of excavated and borrowed materials, backfilling, leveling, grading, compaction, and other earth-

moving work necessary for the construction of the roadway and landings in accordance with these specifications and conforming to the lines, grades, dimensions, and typical cross sections shown on the plans and as marked on the ground.

- 305a - Material used in the construction of embankment sections shall be free of stumps, cull logs, brush, muck, sod, roots, frozen material, and other deleterious materials and shall be placed and compacted as specified.
- 305b - Embankment materials shall be placed in successive parallel layers on areas cleared of stumps, cull logs, brush, sod, and other vegetative and deleterious materials, except as provided under Subsection 204. Roadway embankments of earth material shall be placed in horizontal layers not exceeding eight (8) inches in depth.
- 305d - Where embankments are constructed predominantly of blasted rock material, depth of layers shall not exceed (4) feet. Rock fragments having dimensions greater than 4 feet will be permitted provided that they have no dimensions greater than (6) feet and that clearance between adjacent fragments is adequate for the placing and compacting of material in horizontal layers as specified, and that no part of the larger fragments comes within (4) feet of subgrade.
- 306 - Layers of embankment and selected borrow, as specified under Subsections 305a, 305b, and 317 shall be moistened or dried to a uniform optimum moisture content suitable for maximum density and compacted to full width with compacting equipment conforming to requirements of Subsections 103b, 103g, or 103i. Final Subgrades shall be moistened or dried to a uniform optimum moisture content suitable for maximum density and compacted to full width with compacting equipment conforming to requirements of Subsections 103f or 103i.
- 306c - Compacted materials shall have a uniform density of not less than eighty-five (85) percent of the maximum density as determined by AASHTO T 99, Method A or Method D.
- 308 - In the case of rock fills, placement of material in layers is not required and such material may be placed by end-dumping or other methods approved by the Authorized Officer provided that the rock be reasonably prevented from escaping beyond the embankment toe.
- 311 - In solid rock cuts where pockets that will not drain are formed by blasting below the subgrade elevation, drainage shall be provided by ditching to the edge of the subgrade and backfilling to grade, and compacting the pockets and the ditch with rock fragments, gravel, or other suitable porous material.

313 - In cut areas where solid rock is encountered at, or near subgrade, the rock shall be excavated to a minimum depth of six (6) inches below subgrade elevation and the excavated area backfilled with suitable material. The backfill material shall be processed to the optimum moisture content suitable for maximum density and compacted to full width in accordance with the requirements of Subsection 306.

314 - When heavy clays, muck, clay shale, or other deleterious material for forming the roadbed is encountered in cuts at subgrade, it shall be excavated to a minimum depth of two (2) feet below the subgrade elevation and the excavated area backfilled with a selected borrow material approved by the Authorized Officer. The backfill material shall be uniformly moistened or dried to the optimum moisture content suitable for maximum density in accordance with the requirements of Subsection 306. Unsuitable material shall be disposed of as directed by the Authorized Officer.

315 - Borrow material required for the construction of embankment or for other portions of the work shall be obtained from sources adjacent to the roadway (or source indicated) of the following road sections:

Road No.	Borrow From Sta. To Sta.	Embankment From Sta. To Sta.
2-6-10.1	2-6-11.0 (Sta. 23+80 – 26+70)	Sta. 0+88 – 2+63
2-6-10.1	Sta. 9+10 – 11+69	Sta. 11+69 – 12+85
2-6-11.0	Sta. 17+73 – 19+98	Sta. 19+98 – 21+60
2-6-11.1	Sta. 6+69 – 9+51	Sta. 9+51 – 10+25
2-6-14.6	2-6-15.4 (Sta. 7+88 – 9+81)	Sta. 1+13 – 1+71
2-6-15.4	2-6-14.1 (Sta. 1+54 – 2+05)	Sta. 0+00 – 1+32

316 - Borrow material from sources selected at the Purchaser's option shall be inspected and approved in writing by the Authorized Officer prior to placement.

317 - Selected borrow shall consist of talus material, finely broken rock, gravel, or other material of granular or favorable characteristics from sources shown on the plans.

320 - Ditches shall conform to the slope, grade, dimensions, and shape of the required cross section shown on the plans. Roots, stumps, rocks, and other projections shall be removed to form smooth, even slopes.

321 - Excess excavated, unsuitable, or slide materials shall not be disposed of on areas where the material will encroach on a stream course or other body of water.

Such materials shall be disposed of in accordance with Subsection 321c. Materials not disposed of in this manner shall be retrieved and disposed of at the Purchaser’s expense and at the direction of the Authorized Officer.

- 321a - Excess construction materials specified under Subsection 321 shall be loaded, hauled, and placed as embankment for the roadbed on the following road section:

Road No.	From Sta. To Sta.	To Sta. To Sta.
2-6-10.1	2-6-11.0 (Sta. 23+80 – 26+70)	Sta. 0+88 – 2+63
2-6-10.1	Sta. 9+10 – 11+69	Sta. 11+69 – 12+85
2-6-11.0	Sta. 17+73 – 19+98	Sta. 19+98 – 21+60
2-6-11.1	Sta. 6+69 – 9+51	Sta. 9+51 – 10+25
2-6-14.6	2-6-15.4 (Sta. 7+88 – 9+81)	Sta. 1+13 – 1+71
2-6-15.4	2-6-14.1 (Sta. 1+54 – 2+05)	Sta. 0+00 – 1+32

- 321c - End-dumping will be permitted for the placement of excess materials under Subsection 321 in designated disposal areas or within areas approved by the Authorized Officer. Watering, rolling, and placement in layers are not required. Materials placed shall be sloped, shaped, and otherwise brought to a visible condition acceptable to the Authorized Officer.
- 322 - When so indicated on the plans, selected coarse rock encountered in the excavation shall be conserved for slope protection or special rock embankment purposes and placed in accordance with the requirements and details of Section 1400 of these specifications and as shown on the plans.
- 323 - In the construction of channel changes and stream-crossing embankment sections, natural stream flow shall be maintained unless otherwise provided.
- 324 - Excavated material shall not be allowed to cover boles of standing trees to a depth in excess of a half (1/2) feet on the uphill side.
- 327 - The finished grading shall be approved by the Authorized Officer in segments or for the total project. The Purchaser shall give the Authorized Officer three (3) days’ notice prior to final inspection of the grading operations.

**PIPE CULVERTS - 400**

- 401 - This work shall consist of furnishing and installing pipe culverts, downspouts, and other erosion control devices in accordance with these specifications and conforming to the lines, grades, dimensions, and typical cross sections shown on the plans. Individual lengths and locations are approximate; final lengths and locations will be determined by the Authorized Officer upon completion of the roadbed and upon installation of the appurtenance structures. Additional pipe and erosion control devices may be required at the option of the Authorized Officer, in which case a reduction in the total purchase price shall be made to offset the cost of furnishing and installing such items. Costs will be based upon the unit prices set forth in the current BLM Timber Appraisal Production Cost Schedule.
- 403 - Grade culverts shall have a gradient from two (2) percent to four (4) percent greater than the adjacent road grade. Grade culverts shall be skewed down grade thirty (30) degrees as measured from the perpendicular to the centerline unless otherwise specified on the plans.
- 404 - Damage to the spelter, or burn back in excess of three-eighths (3/8) inch, shall be wire brushed and painted with two coats of zinc-rich paint on zinc-coated steel pipe.
- 405a - Corrugated-(aluminized) steel-welded pipe culverts and pipe-arch culverts and special sections shall conform to the requirements of AASHTO M 36 and AASHTO M 218, AASHTO M 274, or AASHTO M 289 as specified on the plans.
- 405e - Corrugated-polyethylene pipe for culverts 18-inch through 36-inch diameter shall meet the requirements of AASHTO M 294.
- Installation will be subject to the same specification as other pipe materials.
- 406 - Coupling bands shall conform to the requirements of AASHTO M 36 and AASHTO M 274 with the exception of band widths and the "Hugger"-type band which shall conform to the details, dimensions, and typical diagram shown on the plans.
- 406a - "Hugger"-type coupling bands shall only be used with annular corrugated pipe and pipe-arch culverts, or helically corrugated pipe and pipe-arch culverts having annular reformed ends. Annular reformed ends shall consist of two annular corrugations.
- 408 - Pipe culverts shall be placed on the bed starting at the downstream end with the inside circumferential laps pointing downstream and with the longitudinal laps at the side or quarter points. Coupling bands of the type required under these specifications shall be installed so as to provide the circumferential and

longitudinal strength necessary to preserve the pipe alignment, prevent separation of the pipe sections, and minimize infiltration of fill material.

- 409 - Structural-plate pipe culverts and pipe-arch culverts shall be installed in accordance with the plans and detailed erection instructions furnished by the manufacturer. One copy of the erection instructions shall be submitted to the Authorized Officer (3) days prior to erection.
- 410 - Pipe shall be unloaded and handled with reasonable care. If the Authorized Officer determines any structure is damaged to the extent that it is unsuitable for use in the road construction, it shall be replaced at the Purchaser's expense.
- 411 - Trenches necessary for the installation of pipe culverts shall conform to the lines, grades, dimensions, and typical diagram included in the plans and the Culvert Installation Detail Sheet.
- 412 - Where ledge rock, boulders, soft, or spongy soils are encountered, they shall be excavated a minimum of twenty-four (24) inches below the invert grade for a width of at least one (1) pipe diameter or span on each side of the pipe and shall be backfilled with selected granular or fine readily compactable soil material or crushed rock material.
- 413 - All pipe culverts shall be bedded on a 1-1/2"-0" crushed rock material in accordance with Section 1200 gradation. Bedding shall have a depth of not less than six (6) inches as shown on plans. Foundation material shall be of uniform density throughout the length of the structure and shall be shaped to fit the pipe.
- 414a - The invert grade of the bedding shall be cambered at the middle ordinate a minimum of 1 percent of the total length of the drainage structure. Camber shall be developed on a parabolic curve.
- 415 - Inspection of pipe culverts having a diameter of (48) inches and pipe-arch culverts having a height of (40) inches or a cross sectional area of (13) or larger shall be made before backfill is placed. Culverts found to be out of alignment or damaged shall be replaced, reinstalled or repaired as directed by the Authorized Officer at the Purchaser's expense.
- 416 - Side-fill material for pipe culverts shall be placed within one (1) pipe diameter, or a minimum of one (1) foot, of the sides of the pipe barrel, and to a half (1/2) pipe diameter on round pipes with granular material (or 1-1/2"-0" crushed rock material in accordance with Section 1200 gradation if crushed bedding/backfill is required in the rock sheets and Section 413).

The remaining fill material shall be of fine, readily compactable soil and be free of excess moisture, muck, frozen material, roots, sod, or other deleterious or

caustic material and devoid of rocks or stones of sizes which may impinge upon and damage the pipe or otherwise interfere with proper compaction.

- 419 - The pipe culverts, after being bedded and backfilled as required by these specifications, shall be protected by an 18” cover of fill before heavy equipment is permitted to cross the drainage structures.
- 421 - Trenches and bedding rock necessary for the installation of perforated pipe shall conform to the lines, grades, dimensions and typical diagram as shown on the plans.
- 422 - Drain rock shall be carefully placed on geotextile material required in section 1300, to prevent damage or displacement. A minimum 4-inch bedding of drain rock shall be placed and compacted in the bottom of the trench before installing the underdrain pipe. Underdrain pipe shall be firmly embedded in this layer and drain rock placed to the height shown on the plans, or as directed by the Authorized Officer, and then compacted. Care shall be taken not to displace the underdrain pipe or the covering at open joints. Geotextile material shall be overlapped on top of the drain rock a minimum of 1 foot, as shown on the plans. Backfill shall then be placed and compacted in one foot lifts to the required grades.
- 423 - Construction of catch basins conforming to lines, grades, dimensions and typical diagrams shown on the plans, shall be required for grade culverts.
- 424 - Construction of splash pads and energy dissipaters conforming to lines, grades, dimensions and typical diagram shown on the plans, shall be required for grade culverts and culverts as listed on the culvert sheet.
- 426 - Culvert markers consisting of six (6) foot steel fence posts painted blue shall be furnished, fabricated, and installed by the Purchaser at the inlet of all culverts (installed and existing) as marked. Marker shall be installed within six (6) inches of upslope side of culvert inlet.
- 427 - The Purchaser shall record culvert sizes, lengths and location actually installed on a copy of the culvert list. This culvert list shall be furnished to the Authorized Officer.
- 428 - The Purchaser shall remove and dispose of old culverts (removed in the construction phase) in a legal manner, off of Government property, and pay any fees required. The Purchaser shall remove the old culverts from the work site prior to road acceptance.
- 429 - Keep the excavation site dewatered so that the installation of culverts is completed under dry conditions. Dispose of excess water by using pumping or natural



drainage ways near the site in a manner that will avoid damage to adjacent property. Provide for downstream waterflow with no more than ten (10) percent increase in natural stream turbidity due to transport of excavated material or sediment during construction. Diversion streams shall not be returned to the natural channel until all in-stream work has been completed.

- 430 - During culvert installations or replacement activities, all stream flow shall be diverted around the culvert work occurring in live streams, as to maintain downstream flows and minimize turbidity. Woody material removed from stream channels during culvert work shall be placed in the stream channel downstream of the culvert.

#### **RENOVATION AND IMPROVEMENT OF EXISTING ROADS - 500**

- 501 - This work shall consist of reconditioning and preparing the roadbed and shoulders, minor excavation and/or embankment, cleaning and shaping drainage ditches, trimming vegetation from cut and embankment slopes, and cleaning and repairing drainage structures of existing roads in accordance with these specifications, as shown on the plans, and as marked on the ground.
- 501a - This work shall include the removal and disposal of slides in accordance with these specifications and as marked on the ground.
- 502 - The existing road surface shall be bladed and shaped to the lines, grades, dimensions, and typical cross sections shown on the plans.
- 502b - Drainage ditches shall be bladed and shaped in accordance with the lines, grades, dimensions, and typical cross sections shown on the plans.
- 503a - Material from the ditchline reestablishment excavation shall be hauled to designated disposal sites or at locations directed by the Authorized Officer.
- 504 - Existing road surface shall be uniformly moistened or dried to the optimum moisture content suitable for maximum density and compacted to full width with equipment conforming to requirements of Subsections 103f and 103i.
- 504a - Minimum compaction required shall be six (6) passes over each full-width layer, or fraction thereof, as measured along the centerline per layer of material.
- 506 - The inlet end of all existing drainage structures shall be cleared of vegetative debris and boulders that are of sufficient size to obstruct normal flow. Pipe inverts shall be cleared of sediment and other debris lodged in the barrel of the pipe. The outflow area of pipe structures shall be cleared of rock and vegetative obstructions which will impede the structure's designed outflow configuration.

Catch basins shall conform to the lines, grade, dimensions, and typical diagram shown on the plans.

- 508 - Vegetation encroaching on the roadbed and the drainage ditches of existing roads shall be removed by cutting and disposed of in accordance with Subsection 2100 of these specifications.
- 509 - The finished grading and compacting shall be approved by the Authorized Officer. The Purchaser shall give the Authorized Officer three (3) days' notice prior to final inspection of the grading operations.

**WATERING - 600**

- 601 - This work shall consist of furnishing and applying water required for the compaction of embankments, roadbeds, backfills, base courses, surface courses, finishing and reconditioning of existing roadbeds, laying dust, or for other uses in accordance with these specifications.
- 602 - Water, when needed for compaction or laying dust, shall be applied at the locations, in the amounts, and during the hours as directed by the Authorized Officer. Amounts of water to be provided will be the minimum needed to properly execute the compaction requirements in conformance with these specifications.
- 603 - Water trucks used in this work shall be equipped with a distributing device of ample capacity and of such design as to ensure uniform application of water on the road bed.
- 604 - Water required under these specifications shall be obtained at the times and at the locations indicated below:

Willamette Meridian		Dates Available			
Common Name	Section	T	R	From	To
Flora M.L. Site	NW ¼, Section 16	2	6	TBD	TBD
Fairchild Creek Site	SE ¼, Section 11	2	6	TBD	TBD

Use of water sources are subject to applicable State water regulations. In the event that the required water is not available at the locations specified, water shall be obtained from a source approved by the Authorized Officer as permitted by Oregon Water Resources. A reduction shall be made in the total purchase price to reflect additional hauling distance based on rental rates from current BLM Timber Appraisal Cost Schedules. It is estimated that approximately eight hundred sixty-nine thousand (869,000) gallons will be required for processing rock.

- 605 - The Purchaser shall secure the necessary water permits and pay all required water fees for use of the water sources specified under Subsection 604 for use of water sources approved by the Authorized Officer.

**AGGREGATE BASE COURSE - 700**  
**PIT-RUN ROCK MATERIAL**

- 701 - This work shall consist of furnishing, hauling, and placing one or more layers of pit-run rock material on roadbeds and as backfill material approved for placing pit-run materials in accordance with these specifications and conforming to the dimensions and typical cross sections shown on the plans.
- 702a - Pit-run rock materials used in this work may be obtained from commercial or other sources selected by the Purchaser at his option, providing the materials furnished comply with these specifications and the sources are approved in writing by the Authorized Officer prior to use.
- 703 - Pit-run rock materials shall consist of talus rock, partly decomposed granite or basalt, or other approved materials. The materials shall be reasonably free from vegetative matter or other deleterious material.
- 704 - Pit-run rock material shall consist of native materials of such a size and grading that it can be taken directly from the source and placed on the road without crushing or screening.
- The material shall contain only occasional oversize particles to be removed. The term "oversize" shall be construed to mean material greater than six (6) inches.
- 705 - Pit-run rock material shall be placed in layers of sufficient thickness to accommodate the material, except that the maximum thickness of any layer shall not exceed six (6) inches. Where the total specified thickness is greater than six (6) inches the material shall be placed in two (2) or more layers of equal thickness.
- 706 - Oversize material that cannot be accommodated in the layer shall be removed at the source or on the road, and shall be disposed of as directed by the Authorized Officer.
- 707 - When so indicated by the plans, filler or binder obtained from the chosen sources shall be uniformly blended with pit-run rock material on the road.

- 708 - The roadbed as shaped and compacted under sections 400 and 500 of these specifications shall be approved by the Authorized Officer prior to placement of pit-run rock material. Notification for final inspection of base rock shall be three (3) days prior to the spreading of crushed cap rock.
- 709 - Pit-run rock material shall be placed on roadbed, blade processed and spread to required dimensions.
- 711 - Layers of pit-run rock material placed and shaped as specified shall be uniformly moistened or dried to the optimum moisture content for maximum density and compacted to full width by compacting equipment conforming to the requirements of Subsections 103f, 103g, 103h, and 103i. Minimum compaction shall be six (6) passes over each full-width layer, or fraction thereof.
- 712 - Pit-run rock material shall be surface bladed during the compaction operation to remove irregularities and to produce a smooth running surface.
- 713 - Pit-run rock material used to repair or reinforce soft, muddy, frozen, yielding, or rutted subgrades shall not be construed as surfacing required under this specification, unless approved in writing by the Authorized Officer prior to placement.

**AGGREGATE BASE COURSE - 900**  
**SCREENED ROCK MATERIAL**

- 901 - This work shall consist of furnishing, hauling, and placing one or more lifts of screened rock material on roadbeds approved for placing screened rock material in accordance with these specifications and conforming to the dimensions and typical cross sections shown on the plans
- 902a - Screened rock materials to be used in this work may be obtained from a source selected by the Purchaser, at his option, providing the rock materials furnished comply with these specifications and the sources are approved in writing by the Authorized Officer prior to use.
- 903 - Screened rock material shall conform to the following gradation requirements:

Table 903

**SCREENED ROCK MATERIAL GRADATION REQUIREMENTS**

Percentage by Weight Passing Square Mesh Sieves  
(AASHTO T 27)

Sieve Designation	Gradation			
	A	B	C	D
4 inch	100			
3 inch	95-100	100		
2 inch		95-100	100	
1-1/2 inch			95-100	100
1 inch				95-100
No. 4	11-44	16-49	21-54	26-59
No. 200	2-15	2-15	0-15	0-15

- 904 - Screened rock material shall not exceed (35) percent loss as determined by AASHTO T 96.
- 904a - Screened rock material shall show a durability value of not less than 35 as determined by AASHTO T 210.
- 905 - The roadbed as shaped and compacted under sections 300 and 500 of these specifications, shall be approved by the Authorized Officer prior to placement of screened rock materials. Notification for final inspection, prior to rocking, shall be (72) hours prior to that inspection and shall be (10) days prior to start of rock operations.
- 906 - Screened rock material shall be placed in layers not to exceed (6) inches in thickness. Where the required total thickness is more than (6) inches, the rock material shall be shaped and compacted in two or more layers of approximately equal thickness.
- 906a - Screened rock materials used to repair or reinforce a soft, muddy, frozen, yielding, or rutted subgrades shall not be construed as surfacing under this specification.
- 908 - Screened rock material shall be blade-processed and spread to required dimensions. Processing shall be performed in such a manner as to minimize aggregate segregation.
- 909 - Screened rock material shall be compacted by routing construction and hauling equipment over the full width of each layer placed.

**AGGREGATE BASE COURSE - 1000**  
**CRUSHED ROCK MATERIAL**

- 1001 - This work shall consist of furnishing, hauling, and placing one or more layers of crushed rock material on roadbeds and culvert bedding approved for placing crushed rock material, in accordance with these specifications and conforming to the dimensions and typical cross sections shown on the plans.
- Material not conforming to these specifications will be rejected, and shall be removed from the road at the purchaser's expense.
- 1002 - Crushed rock materials used in this work shall consist of quarry rock, stone, gravel, or other approved materials obtained from the source shown on the plans. Development and mining of such source shall be in accordance with Subsections 1601 and 1602a of these specifications.
- 1003 - Crushed rock material produced from gravel shall have two (2) manufactured fractured faces on sixty-five (65) percent, by weight, of the material retained on the No. 4 sieve. If necessary to meet the above requirements or to eliminate an excess of filler, the gravel shall be screened before crushing.
- 1004 - Crushed rock material shall consist of hard durable rock fragments conforming to the following gradation requirements:

TABLE 1004  
AGGREGATE BASE COURSE  
CRUSHED ROCK MATERIAL  
 Percentage by weight passing square mesh sieves  
 AASHTO T 11 & T 27

GRADATION

Sieve Designation	F
3-inch	100
2-inch	65-95
1-1/2-inch	-
1-inch	-
3/4-inch	28-70
No. 4	10-35
No. 30	5-22
No. 40	-
No. 200	3-10

- 1004a - The Purchaser shall submit samples to a certified lab or perform testing for gradation requirements using AASHTO T 11 and AASHTO T 27 testing procedures and also perform testing for sand equivalency requirements using AASHTO T 176 testing procedures. The Purchaser shall provide test results upon request to the Authorized Officer.
- 1005 - Crushed rock material shall not exceed thirty-five (35) percent loss as determined by AASHTO T 96.
- 1006 - Crushed rock material shall show a durability value of not less than thirty-five (35) as determined by AASHTO T210.
- 1007 - That portion of crushed rock material passing the No. 40 sieve, including blending filler, shall have a liquid limit of not more than thirty (35) and a plasticity index of not less than four (4) and not more than twelve (12) as determined by AASHTO T 89 and AASHTO T 90.
- 1008 - If additional binder or filler material is necessary to meet the grading or plasticity requirements or for satisfactory bonding of the material, it shall be uniformly blended with the crushed rock material at the crushing and screening plant prior to placing on the road, unless otherwise agreed. The material for such purposes

shall be obtained from sources approved by the Authorized Officer and shall be free from stones, vegetative matter, and other deleterious materials.

- 1008a - Each layer of crushed rock material shall be thoroughly mixed on the roadbed by alternately blading, to full depth, until a uniform mixture has been obtained. The mixture shall then be spread to full width. When completed, the spreading shall produce a surface which is smooth, presents uniform shoulder lines, and conforms to the specified cross section.
- 1009 - Shaping and compacting of roadbed shall be completed and approved prior to placing crushed rock material, in accordance to the requirements of Subsections 300, 400, and 500. Notification for final inspection of base rock shall be three (3) days prior to the spreading of crushed cap rock.
- 1010 - Crushed rock material conforming to the requirements of these specifications shall be placed on the approved roadbed, turnarounds, and landings in accordance with these specifications and conforming to the lines, grades, dimensions, and typical cross sections shown on the plans and marked on the ground. Compacted layers shall not exceed four (4) inches in depth. When more than one (1) layer is required, each shall be shaped, processed, compacted, and approved by the Authorized Officer before the succeeding layer is placed. Irregularities or depressions that develop during compaction of the top layer shall be corrected by loosening the material at these places and then adding or removing crushed rock material until the surface is smooth and uniform.
- 1010a - Crushed rock material used to repair or reinforce soft, muddy, frozen, yielding, or rutted roadbed shall not be construed as surfacing required by this specification unless approved by the Authorized Officer in advance.
- 1012 - Each layer of crushed rock material placed, processed, and shaped as specified shall be moistened or dried to a uniform moisture content suitable for maximum compaction and compacted to full width by compacting equipment conforming to the requirements of Subsections 103f and 103i . Minimum compaction shall be six (6) passes over each full-width layer, or fraction thereof.

**AGGREGATE SURFACE COURSE – 1200**  
**CRUSHED ROCK MATERIAL**

- 1201 - This work shall consist of furnishing, hauling, and placing one (1) or more layers of crushed rock material on roadbeds, base courses, and culvert bedding approved for placing crushed rock material in accordance with these specifications and conforming to the dimensions and typical cross sections shown on the plans. Material not conforming to these specifications will be rejected, and shall be removed from the road at the purchaser's expense.



- 1202 - Crushed rock materials used in this work shall consist of quarry rock, stone, gravel, or other approved materials obtained from source shown on the plans. Development and mining of such source shall be in accordance with Subsection 1601 and Subsection 1602a of these specifications.
- 1203 - When crushed rock material is produced from gravel, not less than seventy-five (75) percent by weight of the particles retained on the No. 4 sieve will have 4 manufactured fractured faces. If necessary to meet the above requirements or to eliminate an excess of filler, the gravel shall be screened before crushing.
- 1204 - Crushed rock material shall consist of hard durable rock fragments conforming to the following gradation requirements:

TABLE 1204  
AGGREGATE SURFACE COURSE  
CRUSHED ROCK MATERIAL  
 Percentage by weight passing square mesh sieves  
 AASHTO T 11 & T 27  
 GRADATION

Sieve Designation	C-1
1-1/2-inch	100
1-inch	-
3/4-inch	60-90
1/2-inch	-
No. 4	30-55
No. 8	22-43
No. 30	11-27
No. 40	-
No. 200	3-15

- 1204a - The Purchaser shall submit samples to a certified lab or perform testing for gradation requirements using AASHTO T 11 and AASHTO T 27 testing procedures and also perform testing for sand equivalency requirements using AASHTO T 176 testing procedures. The Purchaser shall provide test results upon request to the Authorized Officer.
- 1205 - Crushed rock material retained on the No. 4 sieve shall have a percentage of loss of not more than thirty-five (35) at five hundred (500) revolutions, as determined by AASHTO T 96.

- 1206 - Crushed rock material shall show a durability value of not less than thirty-five (35) as determined by AASHTO T210.
- 1207 - That portion of crushed rock material passing the No. 40 sieve, including blending filler, shall have a liquid limit of not more than thirty-five (35) and a plasticity index of not less than four (4) and not more than twelve (12) as determined by AASHTO T 89 and AASHTO T 90.
- 1208 - If additional binder or filler material is necessary to meet the grading or plasticity requirements or for satisfactory bonding of the material, it shall be uniformly blended with the crushed rock material at the crushing and screening plant prior to placing on the road, unless otherwise agreed. The material for such purposes shall be obtained from sources approved by the Authorized Officer and shall be free from stones, vegetative matter, and other deleterious materials.
- 1208a - Each layer of crushed rock material shall be thoroughly mixed on the roadbed by alternately blading, to full depth, until a uniform mixture has been obtained. The mixture shall then be spread to full width. When completed, the spreading shall produce a surface which is smooth, presents uniform shoulder lines, and conforms to the specified cross section.
- 1209 - Shaping and compacting of roadbed, base course, or culvert trench shall be completed and approved prior to placing crushed rock material, in accordance to the requirements of Subsections 300, 400, 500, and 700. Notification for final inspection of base rock shall be three (3) days prior to the spreading of crushed cap rock.
- 1210 - Crushed rock material conforming to the requirements of these specifications shall be placed on the approved roadbed, landings, base course and culvert trench in accordance with these specifications and conforming to the lines, grades, dimensions, and typical cross sections shown on the plans and marked on the ground. Compacted layers shall not exceed 4 inches in depth. When more than one (1) layer is required, each shall be shaped, processed, compacted, and approved by the Authorized Officer before the succeeding layer is placed.
- Irregularities or depressions that develop during compaction of the top layer shall be corrected by loosening the material at these places and then adding or removing crushed rock material until the surface is smooth and uniform.
- 1210a - Crushed rock material used to repair or reinforce soft, muddy, frozen, yielding, or rutted roadbed shall not be construed as surfacing required by this specification unless approved by the Authorized Officer in advance.
- 1212 - Each layer of crushed rock material placed, processed, and shaped as specified shall be moistened or dried to a uniform moisture content suitable for maximum compaction and compacted to full width by compacting equipment conforming to

the requirements of Subsections 103f, 103g, and 103i . Minimum compaction shall be six (6) passes over each full-width layer, or fraction thereof.

### **GEOTEXTILES – 1300**

- 1301 - This work shall consist of furnishing, hauling, and installing geotextile material at the locations and in accordance with these specifications and the lines, grades, dimensions, and typical cross sections shown on the plans.
- 1302 - Use long-chain, synthetic polymers, composed of at least 95 percent by mass of polyolefins or polyesters, to manufacture geotextile or the threads used to sew geotextile.
- 1303 - Furnish to the Authorized Officer a commercial certification including the name of the manufacturer, product name, style number, chemical composition of the filaments or yarns, and other pertinent information to fully describe the geotextile.
- 1303b - When using a geotextile for a permanent installation limit material exposure to ultraviolet radiation to less than 10 days. Geotextile material deemed to have been overexposed to sunlight by the Authorized Officer shall be rejected.
- 1307 - Where subgrade reinforcement is required, clearing, grubbing, and excavation of the subgrade shall be completed prior to the placement of geotextile material. The subgrade shall be leveled and smoothed to remove lumps and depressions which exceed (6) inches in height and depth. Small pieces of woody debris shall be removed. Light vegetation, i.e., grasses, weeds, leaves, and other small woody debris, may be left in place.
- 1308 - The geotextile material shall be installed directly on the prepared surface. Place the geotextile smooth and free of tension, stress, or wrinkles. Fold or cut the geotextile to conform to curves. Overlap in the direction of construction. Overlap the geotextile a minimum of (2) feet at the ends and sides of adjoining sheets, or sew the geotextile joints according to manufacturer's recommendations. Do not place longitudinal overlaps below anticipated wheel loads. Hold the geotextile in place with pins, staples, or piles of cover material.
- 1309 - End-dump the cover material onto the geotextile from the edge of the geotextile or from previously placed cover material. Do not operate equipment directly on the geotextile. Spread the end-dumped pile of cover material maintaining a minimum lift thickness of (4) inches. Compact the cover material with rubber-tired or non-vibratory smooth drum rollers. Avoid sudden stops, starts, or turns of the construction equipment. Fill all ruts from construction equipment with

additional cover material. Do not re-grade ruts with placement equipment.

- 1310 - Repair or replace all geotextile that is torn, punctured, or muddy. Remove the damaged area and place a patch of the same type of geotextile overlapping 3 feet beyond the damaged area.
- 1311 - Geotextile material used for subgrade reinforcement or material separation shall meet the following requirements:

TABLE 1311b  
 Physical Requirements for Stabilization Geotextile

Property	Test Method ASTM	Units	Specifications <sup>(1)</sup>	
			Type III-A	Type III-B
Grab strength	D 4632	N	1400/900	1100/700
Sewn seam strength	D 4632	N	1260/810	990/630
Tear strength	D 4533	N	500/350	400 <sup>(3)</sup> /250
Puncture strength	D 4833	N	500/350	400/250
Burst strength	D 3786	kPa	3500/1700	2700/1300
Permittivity	D 4491	s <sup>-1</sup>	0.43	0.43
Apparent opening size	D 4751	mm	0.60 <sup>(2)</sup>	0.60 <sup>(2)</sup>
Ultraviolet stability	D 4355	%	50% after 500 hours of exposure	

- (1) The first values in a column apply to geotextiles that break at < 50 percent elongation (ASTM D 4632). The second values in a column apply to geotextiles that break at ≥ 50 percent elongation (ASTM D 4632).
- (2) Maximum average roll value.
- (3) The minimum average tear strength for woven monofilament geotextile is 245 N.

- 1312 - Where geotextile material is specified as filter wrap for underdrains it shall be inert to commonly encountered chemicals, mildew and rot resistant, resistant to ultraviolet light exposure, and insect and rodent resistant.
- 1313 - Trenches for underdrains shall be excavated to the dimensions marked in field. Smooth the trench surfaces by removing all projections that may damage the geotextile. Minimum slope of trenches shall be one percent. The Authorized Officer shall have a minimum of 3 days notice in which to approve trenches prior to installation of the geotextile material, pipe, drain rock, or other backfill.
- 1314 - Geotextile material used as a filter shall be placed in a manner and at the locations shown on the plans. Place the long dimension of the geotextile parallel to the centerline of the trench. Position the geotextile, without stretching, in contact

with the trench surface. Overlap the joints a minimum of 24 inches with the upstream geotextile placed over the downstream geotextile. Replace geotextile damaged during installation.

- 1315 - Geotextile materials used for subsurface drainage shall meet the following requirements:

TABLE 1315  
Physical Requirements for Subsurface Drainage Geotextile

Property	Test Method ASTM	Units	Specifications <sup>(1)</sup>					
			Type I-A	Type I-B	Type I-C	Type I-D	Type I-E	Type I-F
Grab strength	D 4632	N	1100/700	1100/700	1100/700	800/500	800/500	800/500
Sewn seam strength	D 4632	N	990/630	990/630	990/630	720/450	720/450	720/450
Tear strength	D 4533	N	400 <sup>(3)</sup> /250	400 <sup>(3)</sup> /250	400 <sup>(3)</sup> /250	300/175	300/175	300/175
Puncture strength	D 4833	N	400/250	400/250	400/250	300/175	300/175	300/175
Burst strength	D 3786	kPa	2750/1350	2750/1350	2750/1350	2100/950	2100/950	2100/950
Permittivity	D 4491	s <sup>-1</sup>	0.5	0.2	0.1	0.5	0.2	0.1
Apparent opening size	D 4751	mm	0.43 <sup>(2)</sup>	0.25 <sup>(2)</sup>	0.22 <sup>(2)</sup>	0.43 <sup>(2)</sup>	0.25 <sup>(2)</sup>	0.22 <sup>(2)</sup>
Ultraviolet stability	D 4355	%	50% after 500 hours of exposure					

- (1) The first values in a column apply to geotextiles that break at < 50 percent elongation (ASTM D 4632). The second values in a column apply to geotextiles that break at ≥ 50 percent elongation (ASTM D 4632).  
(2) Maximum average roll value.  
(3) The minimum average tear strength for woven monofilament geotextile is 245 N.

**SLOPE PROTECTION - 1400**

- 1401 - This work shall consist of furnishing, hauling, and placing stone materials for slope protection structures, splash pads, and road blockages in accordance with these specifications and conforming to the lines, grades, dimensions, and typical cross-sections shown on the plans. Material not conforming to these

specifications will be rejected and shall be removed from the slope protection structure at the purchaser's expense and as directed by the Authorized Officer.

- 1402 - Stone material shall consist of hard angular quarry rock of such quality that it will not disintegrate on exposure to water or weathering, and shall be graded in accordance with these specifications.

Volume/ Cubic Foot	Average Dimension in inches	Approximate Weight in Pounds
12	27.5 x 27.5 x 27.5	2100
6	21.8 x 21.8 x 21.8	1050
4	19.1 x 19.1 x 19.1	700
3	17.3 x 17.3 x 17.3	525
1	12.0 x 12.0 x 12.0	175
2/3	10.5 x 12.0 x 12.0	120
1/2	9.5 x 9.5 x 9.5	88
1/3	8.3 x 8.3 x 8.3	60
1/4	7.6 x 7.6 x 7.6	44
1/6	6.6 x 6.6 x 6.6	30
1/8	6.0 x 6.0 x 6.0	22
1/100	2.6 x 2.6 x 2.6	2

- 1404 - The material shall be well graded from the smallest to the maximum size specified. Stones smaller than the specified ten (10) percent size shall consist of spalls and fine rock fragments so distributed as to provide a stable compact mass.

- 1405 - Rip rap shall conform to the following gradations:

TABLE 1405

Class	% of Rock Equal or Smaller by Count, Dx	Range of Intermediate Dimensions, inches	Range of Rock Mass, pounds
5	100	33 - 39	2900 – 4850
	85	23 - 28	990 – 1800
	50	17 – 20	400 – 650
	15	11- 15	110 – 270

Rocks smaller than six inches in diameter are not counted.

- 1405a - Stone materials shall show a durability value of not less than fifty (50) as determined by AASHTO T 210.
- 1406a - The embankment shall be placed in successive horizontal layers of sufficient depth to contain the maximum size rock present in the material. Spalls and finer

fragments of stone other than specified in Subsection 1405 shall be used to chock the larger stones solidly in position and to fill voids between the major stones as laid in the embankment. The exposed face of the embankment shall be reasonably smooth and uniform; material shall be prevented from escaping beyond the toe of the structure

- 1407 - Determination of the acceptability of the slope protection material gradation will be through visual inspection and physical measurements by the Authorized Officer.
- 1408 - Trenches for slope protection structures shall be excavated to the lines, elevations, and typical diagram shown on the plans. They shall be of sufficient size to permit the placing of structure footing of the full widths and length shown. Trenches shall be approved by the Authorized Officer prior to placement of slope protection material.
- 1408a - Foundation trenches and other required excavation as shown on the plans shall be approved prior to placing the slope protection material.

#### **EROSION CONTROL - 1700**

- 1701 - This work shall consist of measures to control soil erosion or water pollution during the construction operation through the use of berms, dikes, dams, sediment basins, fiber mats, netting, gravel, mulches, grasses, slope drains, and other erosion control devices or methods in accordance with these specifications and conforming to the lines, grades, dimensions and typical cross sections shown on the plans.
- 1704 - The erosion control provisions specified under this Subsection shall be coordinated with the Soil Stabilization requirements of Section 1800 and the Geotextile requirement of Section 1300.
- 1708 - Newly constructed and renovated roads to be carried over the winter period, shall be blocked to vehicular traffic and waterbars installed.
- 1708a - Road segments not completed during dry weather periods shall be winterized, by providing a well-drained roadway using waterbars, maintaining drainage, and performing additional measures necessary to minimize erosion and other damage to the roadway, as directed by the Authorized Officer. Portions of roads not having surface rock in place will be blocked or barricaded to prevent vehicular traffic. A winterization plan shall be submitted to the Authorized Officer no later than September 15<sup>th</sup> of each harvest season.

- 1711 - The Purchaser shall construct sediment catch basins with straw bales at the following locations: 2-5-10.0 (MP. 0.205, 0.517, 0.622, 1.468, 1.582, 1.621, 1.648, 1.923, 1.947, 2.298, 2.699, 3.927, 3.939, 3.991, 4.145, 4.157, 4.363, 4.372, 4.474, 4.727, 5.602, 6.914, 6.947), 2-5-29.1 (MP. 0.068, 0.464, 0.502, 0.516, 0.852, 0.858, 1.023, 1.035, 1.127, 1.602, 1.843, 1.861, 2.230, 2.237), 2-6-9.1 (MP. 0.186, 0.222, 0.358, 0.518), 2-6-11.1 (Sta. 17+86, 19+16, 33+99, 34+50)

**SOIL STABILIZATION – 1800**

- 1801 - This work shall consist of seeding on designated cut, fill, borrow, disposal, and special areas in accordance with these specifications and as shown on the plans. This work is not required for road acceptance under Section 18 of this contract. Grass seed will be furnished by the Government. Straw Mulch shall be furnished by the Government.
- 1802a - Soil stabilization work consisting of seeding and mulching shall be performed on new road construction, road renovation and improvement, landings, borrow sites, and disposal sites in accordance with these specifications and as shown on the plans. The seed shall be spread at a rate of sixty (60) pounds/acre, (to be determined by the Authorized Officer based on visual observation of trial applications).
- 1803 - Soil stabilization work as specified under Subsection 1802a shall be performed during the following seasonal periods:

From	To
August 1	October 15

The Authorized Officer may modify the above seasonal dates to conform to existing weather conditions and changes in the construction schedule.

- 1809 - Mulch material conforming to the requirements of Subsections 1809a and 1809b shall be furnished by the Government and shall be delivered to the work area in a dry state. Material to be used in the mulching operation may be stockpiled along the road designated for treatment.
- 1809a - Straw mulch shall be from oats, wheat, rye, or other approved grain crops which are free from noxious weeds, mold, or other objectionable materials. Straw mulch shall be in an air-dry condition and suitable for placing with power spray equipment.
- 1809b - Grass straw mulch shall be from perennial grass or, if specified, an annual rye grass, from which the seed has been removed. The straw shall be free from Bentgrass, Canada Thistle, Tansy Ragwort, Skeleton weed, and other noxious



weed seed. The grass straw shall be from fields which have passed the current year's field inspection of the Oregon Grass Seed Certification program, or from fields certified by the County Agent, or by seed companies purchasing the seed.

- 1810 - Bulk mulching material required under these specifications shall be delivered to the work area bound either by twine, string or hemp rope. Wire binding will not be permitted.
- 1811 - The Purchaser shall apply to the disturbed soils that are wet and/or within fifty (50) feet each side of "live stream" locations and all disposal sites a mixture of grass seed and straw mulch material at the application rate of six (6) pounds seed/acre and three thousand (3000) pounds straw mulch/acre (to be determined by Authorized Officer based on visual observation of trial applications).
- 1814 - The Purchaser may reduce the application rate on partially covered slopes and refrain from application on areas already well stocked with grass or on rock surfaces as determined by the Authorized Officer.
- 1815b - Dry Method - Blowers, mechanical seeders, seed drills, landscape seeders, cultipaker seeders, fertilizer spreaders, or other approved mechanical seeding equipment may be used when seed and fertilizer are to be applied in dry form.
- 1819 - The Purchaser shall notify the Authorized Officer at least three (3) days in advance of date he intends to commence the specified soil stabilization work.
- 1824 - Twine, rope, sacks, and other debris resulting from the soil-stabilization operation shall be picked up and disposed of to the satisfaction of the Authorized Officer.

#### **ROADSIDE BRUSHING - 2100**

- 2101 - This work shall consist of the removal of vegetation from the road prism - variable distance, and inside curves in accordance with these specifications and conforming to the lines, grades, dimensions, and typical cross sections shown on the Roadside Brushing Detail Sheet of this exhibit, at designated locations as shown in the plans.
- 2102 - Roadside brushing may be performed mechanically with self powered, self-propelled equipment, or manually with hand tools, including chain saws.
- 2103 - Vegetation cut manually or mechanically less than six (6) inches in diameter shall be cut to a maximum height of two (2) inches above the ground surface or above obstructions such as rocks or stumps on cut and fill slopes and all limbs below the six (6) inch area will be severed from the trunk.
- 2104 - Trees in excess of six (6) inches in diameter shall be limbed, so that no limbs extend into the treated area or over the roadbed to a height of fourteen (14) feet

above the running surface of the roadway on cut and fill slopes, within the road prism-variable distance. Limbs shall be cut to within four (4) inches of the trunk to produce a smooth vertical face. Removal of trees larger than six (6) inches in diameter for sight distance or safety may be directed by the Authorized Officer.

- 2105 - Vegetation that is outside of the road prism-variable distance that protrudes into the road prism and within fourteen (14) feet in elevation above the running surface shall be cut, to within four (4) inches of the trunk to produce a smooth vertical face.
- 2106 - Vegetative growth capable of growing one (1) foot in height or higher shall be cut, within the road prism-variable distance or as directed by the Authorized Officer.
- 2107 - Inside curves shall be brushed out for a sight distance of two hundred (200) feet chord distance and/or a middle ordinate distance of twenty-five (25) feet, whichever is achieved first. Overhanging limbs and vegetation in excess of one (1) foot in height, shall be cut within these areas.
- 2109 - Debris resulting from this operation shall be scattered downslope from the roadway. Debris shall not be allowed to accumulate in concentrations. Debris in excess of one (1) foot in length and two (2) inches in diameter shall not be allowed to remain on cut slopes, ditches, roadways or water courses, or as directed by the Authorized Officer.
- 2112 - Roadside brushing shall be performed during the following seasonal periods:

*From	To
June 1	October 15

\*Brushing may occur during the “wet season” given the following guidelines are followed:

- 1) Activity would be suspended when conditions exist that could generate sediment inputs into streams, such as times of intense or prolonged rainfall where water in ditches is flowing, or streamflow, as measured above and below the effects of the road, becomes discolored.
- 2) Activity would be suspended when road surface shows signs of serious deterioration such as excessive rutting or pumping of fines from the sub-grade.
- 3) Activity would be suspended upon decision of Authorized Officer.

- 2113 - Roadside brushing shall be accomplished on the following road segments: 2-5-29.1, 2-6-3.0, 2-6-9.1, 2-6-11.0 (Sta. 0+00 – 44+13), 2-6-12.1, 2-6-14.0, 2-6-14.1, 2-6-14.2 (Sta. 0+00 – 17+80), and 2-6-14.4.
- 2116 - Traffic warning signs shall be required at each end of the work area. Signs shall meet the requirements of the Manual on Uniform Traffic Devices.

### **SLOPE STAKING - 2300**

- 2301 - This work shall consist of slope staking (and referencing) road locations from slope stake notes furnished by the BLM in accordance with these specifications and conforming to the lines, grades, dimensions, and typical cross sections shown on the plans.
- 2302 - Slope stakes shall consist of (1-3/4 inch x 1/4 inch) smooth-finished wood slats of good quality, approximately eighteen (18) inches in length and tipped with red luminous paint.
- 2303 - Slope stakes shall be set as follows:
  - (a) A slope stake shall be set at the top of the cut slope for cut and fill and full bench sections.
  - (b) (For fill sections, only the uphill side shall be staked, unless otherwise specified).
  - (c) (For balanced sections both sides of the road shall be staked.)
  - (d) Stakes shall be set at a maximum interval of one hundred (100) feet and at a maximum interval of fifty (50) feet on curves.
  - (e) The slope stake shall be left in the slope stake location at time of staking. The Purchaser shall reset the slope stakes after completion of clearing and grubbing operations, where needed.
- 2304 - A reference marker consisting of a yellow plastic tag nailed or stapled to the base of a stump or tree shall be set for each slope stake. If no stumps or trees are available, a stake identical to that used for slope staking may be used. Reference markers shall be readily visible from the slope stake and shall be set outside of the posted right-of-way.
- 2309 - Stationing used is "L" or final location stationing.
- 2310 - Stakes shall be marked with black-lumber crayon or with a permanent waterproof

felt-tip marker.

- 2311 - Slope and reference stakes shall be set to the following standards of accuracy:

maximum allowable horizontal error +/-	Two (2) feet
maximum allowable vertical error +/-	One (1) foot

- 2313 - The BLM will slope stake and reference and furnish the Purchaser the resulting notes in advance of construction on the roads shown below:

Road No.	
2-6-14.1	Sta. 0+00 – 2+06
2-6-14.2	Sta. 17+80 – 21+67
2-6-14.6	Sta. 0+00 – 3+62
2-6-15.4	Sta. 0+00 – 9+81

- 2314 - Data for slope staking is available at the BLM Northwest Oregon District (Tillamook Field Office). P - Ground, Grade, Shift, and Template information shall be used to determine actual slope staked location.

**BARRICADES AND CONTROL DEVICES - 2700**

- 2701 - This work will consist of furnishing and placement of barricades, warning signs, and other protection required to prevent injury to people and damage to property due to culvert installations, brushing, and other construction work. Purchaser shall submit a site plan showing how the specifications in this section and of Sec. 42 will be accomplished.
- 2702 - Maintain condition, operation, and effectiveness of traffic control devices throughout period of use. Materials used for the temporary structures and controls are property of Contractor and shall be removed from Government land when need for their service has ended.

United States Department of Interior  
 BUREAU OF LAND MANAGEMENT  
 NORTHWEST OREGON DISTRICT - OREGON  
**Road Plan Map**

T. 02S. R. 6W. Sections 10, 11, 13, & 14 W.M. - NORTHWEST OREGON DISTRICT - OREGON

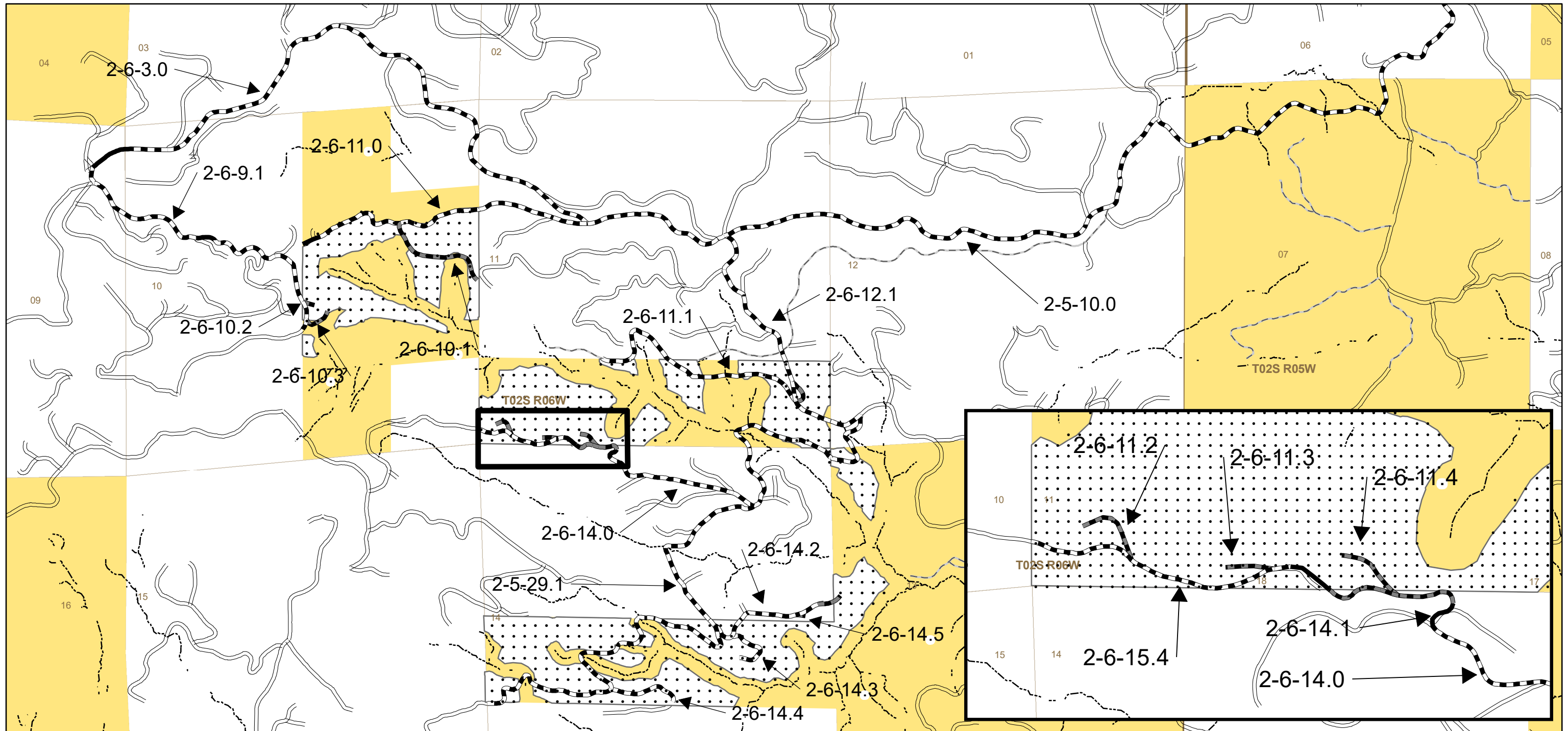

- Rocked surfaced road to be improved, Open after use
- Rocked surfaced road to be constructed, Open after use
- Rocked surfaced road to be renovated, Open after use
- Existing Roads
- Fairchild Project Area
- Bureau of Land Management
- Streams

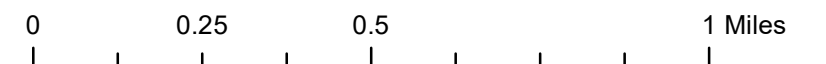

No warranty is made by the Bureau of Land Management as to the accuracy, reliability, or completeness of these data for individual or aggregate use with other data. Original data were compiled from various sources and may be updated without notification.  
 Prepared By: Austin Bettis





United States Department of Interior  
 BUREAU OF LAND MANAGEMENT  
 NORTHWEST OREGON DISTRICT - OREGON  
**Road Plan Map**

Fairchild Timber Sale  
 Contract NO. ORN04-TS-2020.0402  
 Exhibit C  
 Page 43 of 61

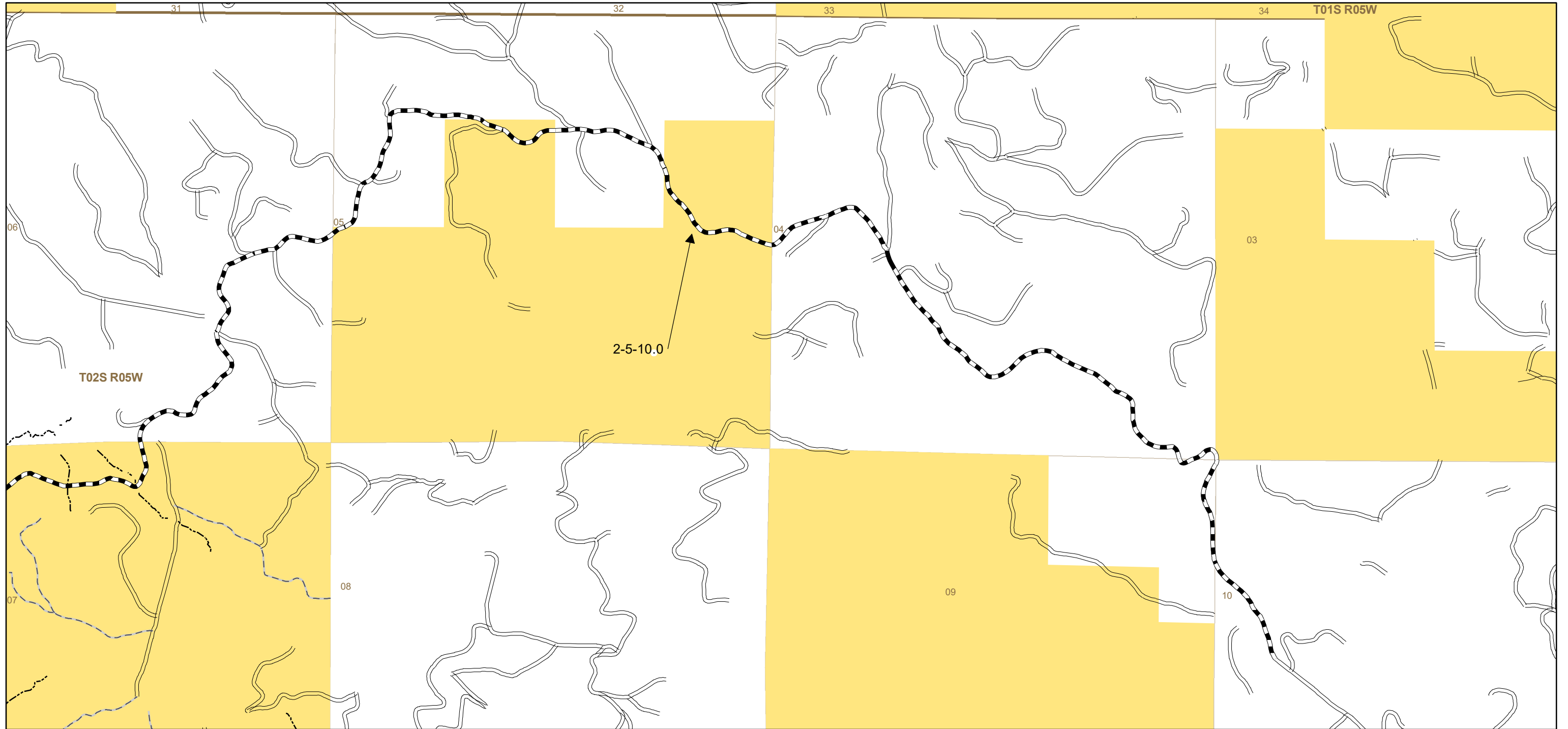
  
 N  
 6/18/2020

T. 02S. R. 6W. Sections 10, 11, 13, & 14 W.M. - NORTHWEST OREGON DISTRICT - OREGON

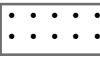

-  Rocked surfaced road to be renovated, Open after use
-  Existing Roads
-  Fairchild Project Area
-  Bureau of Land Management
-  Streams

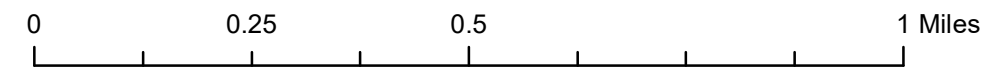

No warranty is made by the Bureau of Land Management as to the accuracy, reliability, or completeness of these data for individual or aggregate use with other data. Original data were compiled from various sources and may be updated without notification.  
 Prepared By: Austin Bettis

U.S. DEPT. OF THE INTERIOR  
 Bureau of Land Management  
 NORTHWEST OREGON DISTRICT OFFICE - OREGON

**Earth Barricade, Waterdip, Drivable and Non-Drivable Waterbar Details**

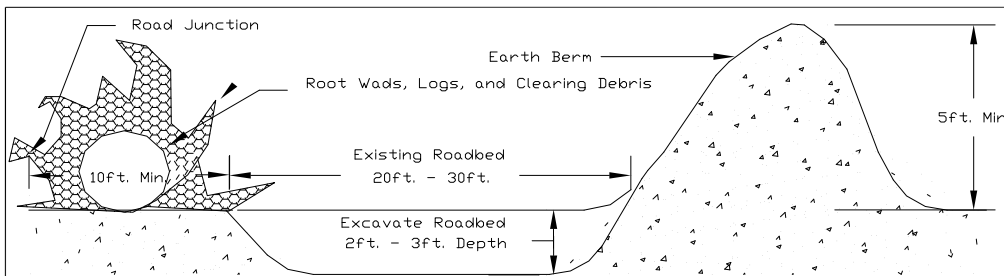

EARTH BARRICADE CONSTRUCTION

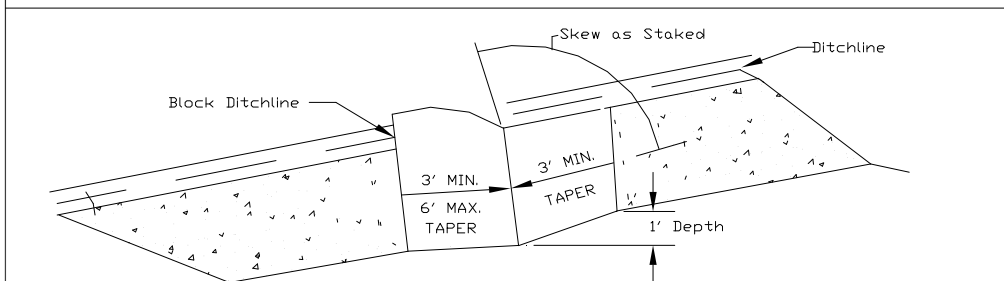

DRIVABLE WATERBAR CONSTRUCTION

NOTE:

1. DITCHLINE IS TO BE BLOCKED WITH EXCAVATED MATERIAL TO PREVENT DITCH WATER FROM BYPASSING WATERBAR.
2. EXCESS MATERIAL SHALL BE UNIFORMLY SPREAD ALONG ROADWAY. NO MATERIAL WILL BE ALLOWED BEYOND THE OUTER ROAD EDGE.

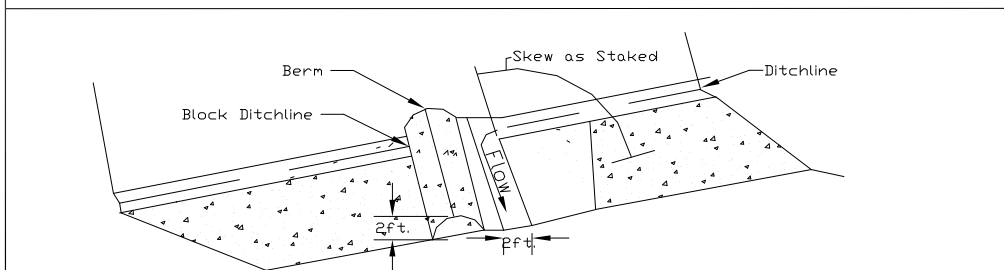

NON-DRIVABLE WATERBAR CONSTRUCTION

**WATER DIP DETAIL**

Not to Scale

NOTE: PLAN OF DIP SHOWN IS FOR OUTSLOPED ROLLING DIP, DIPS MAY BE EITHER INSLOPED OR OUTSLOPED. WHEN INSLOPED, DIPS SHALL DISCHARGE INTO A CULVERT, DROP INLET, OR OVERSIDE DRAIN, OR DRAINAGE DITCH. WHEN OUTSLOPED, THEY SHALL DISCHARGE INTO AN OVERSIDE DRAIN OR ON TO NATURAL GROUND. THE MINIMUM CROSS GRADE FROM "B" TO "E" IS 4% GREATER THAN THE ORIGINAL ROAD GRADE. SKEW LINE B-E TO FIT LOW POINT IN DRAW, IF LOCATED IN NATURAL DRAIN.

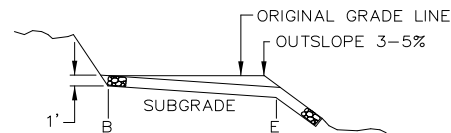
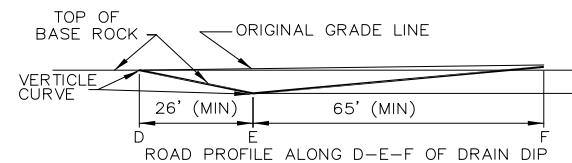
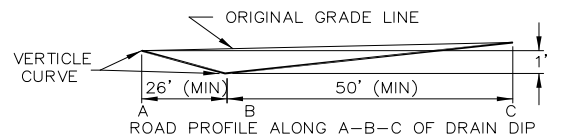
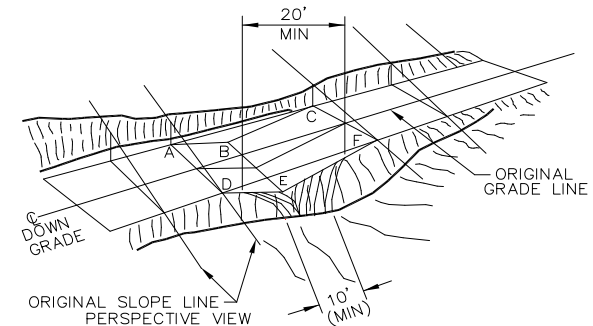

ROCK SPILL APRON 15' WIDE WITH MATERIAL AS SHOWN ON SCHEDULE OF ITEMS TO TOE OF FILL.

U.S. DEPT. OF THE INTERIOR  
 Bureau of Land Management  
 NORTHWEST OREGON DISTRICT OFFICE - OREGON

**BRUSHING DETAILS**

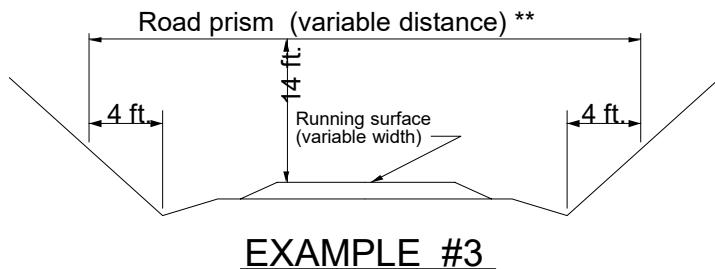
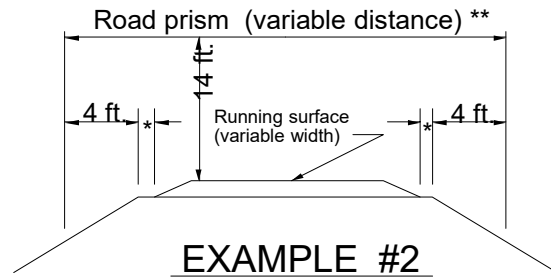
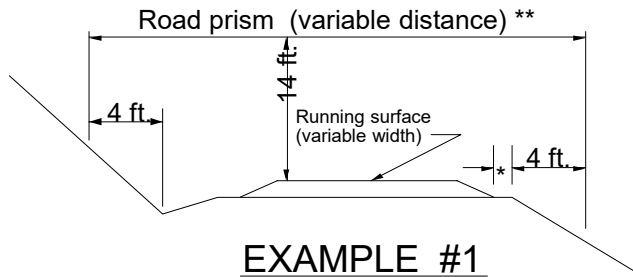

(NO SCALE)

- \* Variable distance between running surface and start of fill slope
- \*\* All areas within the variable distance shall be free of all vegetation capable of growing one (1) foot in height or higher and all overhanging limbs and branches 14 feet in elevation above the running surface

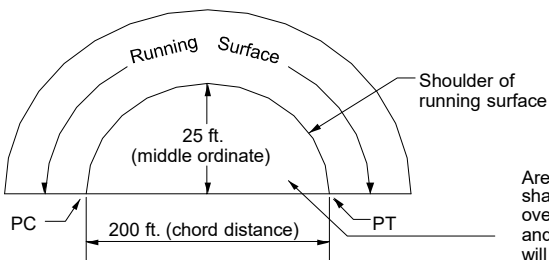

**SIGHT DISTANCE DIAGRAM**

Area to be cut: shall be free of overhanging limbs and all vegetation will be cut to a maximum height of one (1) foot.



**Culvert List**

CULVERT LOCATIONS							DOWNSPOUT(d) or STANDPIPE(s) *4				AS BUILT			ROCK			REMARKS *6		
DESIGNED *2														RIP RAP (GRADING)					
														(a)				(b)	
Road #	Sta./ M.P	SIZE	GAGE	LENGTH	CULVERT GRADE	INSTALL TYPE *3	SIZE	TYPE	LENGTH	TYPE OF ELBOW *5	SIZE	GAGE	LENGTH	INLET	OUTLET	Structure inside pipe			
2-5-10.0 (Turner Creek Rd.)	0.137	--	--	--	--	--	--	--	--	--	--	--	--	--	--	--	Install metal inlet marker on existing CMP		
	0.156	--	--	--	--	--	--	--	--	--	--	--	--	--	--	--	Install metal inlet marker on existing CMP		
	0.174	--	--	--	--	--	--	--	--	--	--	--	--	--	--	--	Install metal inlet marker on existing CMP		
	0.196	--	--	--	--	--	--	--	--	--	--	--	--	--	--	--	Install metal inlet marker on existing CMP		
	0.288	--	--	--	--	--	--	--	--	--	--	--	--	--	--	--	Install metal inlet marker on existing CPP		
	0.609	--	--	--	--	--	--	--	--	--	--	--	--	--	--	--	Replace metal inlet marker on existing CPP		
	0.889	--	--	--	--	--	--	--	--	--	--	--	--	--	--	--	Install metal inlet marker on existing CPP		
	0.951	--	--	--	--	--	--	--	--	--	--	--	--	--	--	--	Install metal inlet marker on existing CPP		
	1.106	--	--	--	--	--	--	--	--	--	--	--	--	--	--	--	Install metal inlet marker on existing CPP		
	1.309	--	--	--	--	--	--	--	--	--	--	--	--	--	--	--	Install metal inlet marker on existing CMP		
	1.586	--	--	--	--	--	--	--	--	--	--	--	--	--	--	--	Install metal inlet marker on existing CMP		
	1.635	--	--	--	--	--	--	--	--	--	--	--	--	--	--	--	Install metal inlet marker on existing CMP		
	1.656	18"	--	50'	--	--	--	--	--	--	--	--	--	--	--	--	Install New Culvert as marked in field and directed by Authorized Officer. Place 20 CY 1-1/2"-0" Crushed Bedding/Backfill Rock. Spread 20 CY 4"-0" Crushed Base Rock over Pipe for Surfacing capped with 15 CY 1-1/2"-0" Crushed Rock. Install metal inlet marker.		
	1.852	--	--	--	--	--	--	--	--	--	--	--	--	--	--	--	Install metal inlet marker on existing CMP		
	1.921	42"	14	30'	--	--	--	--	--	--	--	--	--	--	--	--	Stream. Replace Existing Culvert as marked in the field and directed by Authorized Officer (approx. 6' fill @ CL). Place 25 CY 1-1/2"-0" Crushed Bedding/Backfill Rock. Spread 25 CY 4"-0" Crushed Base Rock over Pipe for Surfacing capped with 20 CY 1-1/2"-0" Crushed Rock. Install metal inlet marker.		
	2.418	--	--	--	--	--	--	--	--	--	--	--	--	--	--	--	Existing Catch Basin is too deep, fix with compacted native material. Install metal inlet marker on existing CPP.		
	2.542	--	--	--	--	--	--	--	--	--	--	--	--	--	--	--	Existing Catch Basin is too deep, fix with compacted native material. Install metal inlet marker on existing CMP.		
	2.648	--	--	--	--	--	--	--	--	--	--	--	--	--	--	--	Existing Catch Basin is too deep, fix with compacted native material. Install metal inlet marker on existing CMP.		
	2.769	--	--	--	--	--	--	--	--	--	--	--	--	--	--	--	Install metal inlet marker on existing CPP		
	2.844	--	--	--	--	--	--	--	--	--	--	--	--	--	--	--	Install metal inlet marker on existing CMP		

Gage Chart		
Gage	Dec. Inches	
	Steel	Alum.
10	.138	.135
12	.109	.105
14	.079	.075
16	.064	.060

1. Designed culvert lengths and locations are approximate.  
\*2. all culverts have 2-2/3" x 1/2" unless otherwise noted.

\*4. Downspout or Standpipe Types  
1) Full \*\*\* Downspouts and stand pipes (under 36" diameter) shall be CPP, Type C (single wall).  
2) Half  
3) Flume

\*5. 1) Conventional or Fabricated  
2) Turner type  
3) Slip joint  
\*6. Include special sections, structures, headwalls, footings & other data.

\*\*\*\* Corrugated plastic pipe (CPP), Type S (double wall) shall be used for culvert sizes 36" and smaller. All larger culverts shall be aluminized steel. Culverts 20' in length or smaller shall be one piece (no joints). No Culvert piece shall be shorter than 6 foot. Minimization of banding is required.

**Culvert List**

CULVERT LOCATIONS											ROCK			REMARKS *6			
DESIGNED *2							DOWNSPOUT(d) or STANDPIPE(s) *4				AS BUILT				RIP RAP (GRADING)		
															(a)	(b)	
Road #	Sta./ M.P	SIZE	GAGE	LENGTH	CULVERT GRADE	INSTALL TYPE *3	SIZE	TYPE	LENGTH	TYPE OF ELBOW *5	SIZE	GAGE	LENGTH	INLET	OUTLET	Structure inside pipe	
2-5-10.0 (Turner Creek Rd.)	3.157	--	--	--	--	--	--	--	--	--	--	--	--	--	--	--	Install metal inlet marker on existing CPP.
	3.601	--	--	--	--	--	--	--	--	--	--	--	--	--	--	--	Install metal inlet marker on existing CPP.
	3.663	--	--	--	--	--	--	--	--	--	--	--	--	--	--	--	Install metal inlet marker on existing CPP.
	3.733	--	--	--	--	--	--	--	--	--	--	--	--	--	--	--	Existing Catch Basin is too deep, fix with compacted native material. Install metal inlet marker on existing CMP.
	3.834	--	--	--	--	--	--	--	--	--	--	--	--	--	--	--	Install metal inlet marker on existing CPP.
	3.932	--	--	--	--	--	--	--	--	--	--	--	--	--	--	--	Install metal inlet marker on existing CMP.
	3.999	--	--	--	--	--	--	--	--	--	--	--	20	--	--	--	Stream. Water is going subsurface and not entering existing CMP. Excavate a 25' long, 15' wide, and 3' deep channel @ inlet and place 70 SY of woven geo-synthetic fabric as directed. Place 20 CY Class 5 RipRap capped with 30 CY 4"-0" Crushed Base Rock onto fabric and direct water into culvert as directed.
	4.112	18"	--	45'	--	--	--	--	--	--	--	--	--	--	--	--	Install New Culvert as marked in field and directed by Authorized Officer (approx. 7' fill @ CL). Place 20 CY 1-1/2"-0" Crushed Bedding/Backfill Rock. Spread 20 CY 4"-0" Crushed Base Rock over Pipe for Surfacing capped with 15 CY 1-1/2"-0" Crushed Rock. Install metal inlet marker.
	4.151	--	--	--	--	--	--	--	--	--	--	--	--	--	--	--	Install metal inlet marker on existing CMP.
	4.202	18"	--	50'	--	--	--	--	--	--	--	--	--	--	--	--	Install New Culvert as marked in field and directed by Authorized Officer (approx. 10' fill @ CL). Place 20 CY 1-1/2"-0" Crushed Bedding/Backfill Rock. Spread 20 CY 4"-0" Crushed Base Rock over Pipe for Surfacing capped with 15 CY 1-1/2"-0" Crushed Rock. Install metal inlet marker.
	4.332	18"	--	40'	--	--	--	--	--	--	--	--	--	--	--	--	Install New Culvert as marked in field and directed by Authorized Officer (approx. 7' fill @ CL). Place 20 CY 1-1/2"-0" Crushed Bedding/Backfill Rock. Spread 20 CY 4"-0" Crushed Base Rock over Pipe for Surfacing capped with 15 CY 1-1/2"-0" Crushed Rock. Install metal inlet marker.
	4.370	24"	--	55'	--	--	--	--	--	--	--	--	--	40	--	--	Stream. Replace Existing Culvert as marked in the field and directed by Authorized Officer (approx. 8' fill @ CL). Place 25 CY 1-1/2"-0" Crushed Bedding/Backfill Rock. Spread 20 CY 4"-0" Crushed Base Rock over Pipe for Surfacing capped with 15 CY 1-1/2"-0" Crushed Rock. Place 40 CY Class 5 RipRap @ outlet as fill armor/dissipater. Install metal inlet marker.
	4.396	18"	--	40'	--	--	--	--	--	--	--	--	--	--	--	--	Install New Culvert as marked in field and directed by Authorized Officer. Place 20 CY 1-1/2"-0" Crushed Bedding/Backfill Rock. Spread 20 CY 4"-0" Crushed Base Rock over Pipe for Surfacing capped with 15 CY 1-1/2"-0" Crushed Rock. Install metal inlet marker.
	4.729	--	--	--	--	--	--	--	--	--	--	--	--	--	--	--	Install metal inlet marker on existing CPP.
	4.751	--	--	--	--	--	--	--	--	--	--	--	--	--	--	--	Install metal inlet marker on existing CPP.
	5.134	--	--	--	--	--	--	--	--	--	--	--	--	--	--	--	Install metal inlet marker on existing CPP.
	5.209	--	--	--	--	--	--	--	--	--	--	--	--	--	--	--	Install metal inlet marker on existing CPP.

Gage Chart		
Gage	Dec. Inches	
	Steel	Alum.
10	.138	.135
12	.109	.105
14	.079	.075
16	.064	.060

1. Designed culvert lengths and locations are approximate.

\*2. all culverts have 2-2/3" x 1/2"

unless otherwise noted.

\*\*\*\* Corrugated plastic pipe (CPP), Type S (double wall) shall be used for culvert sizes 36" and smaller. All larger culverts shall be aluminized steel. Culverts 20' in length or smaller shall be one piece (no joints). No Culvert piece shall be shorter than 6 foot. Minimization of banding is required.

\*4. Downspout or Standpipe Types

- 1) Full \*\*\* Downspouts and stand pipes (under 36" diameter) shall be CPP, Type C (single wall).
- 2) Half
- 3) Flume

\*5. 1) Conventional or Fabricated  
2) Turner type  
3) Slip joint

\*6. Include special sections, structures, headwalls, footings & other data.

**Culvert List**

CULVERT LOCATIONS											ROCK			REMARKS *6			
DESIGNED *2							DOWNSPOUT(d) or STANDPIPE(s) *4				AS BUILT				RIP RAP (GRADING)		
															(a)	(b)	
Road #	Sta./ M.P	SIZE	GAGE	LENGTH	CULVERT GRADE	INSTALL TYPE *3	SIZE	TYPE	LENGTH	TYPE OF ELBOW *5	SIZE	GAGE	LENGTH	INLET	OUTLET	Structure inside pipe	
2-5-10.0 (Turner Creek Rd.)	5.299	--	--	--	--	--	--	--	--	--	--	--	--	--	--	--	Install metal inlet marker on existing CPP.
	5.411	--	--	--	--	--	--	--	--	--	--	--	--	--	--	--	Install metal inlet marker on existing CMP.
	5.580	--	--	--	--	--	--	--	--	--	--	--	--	--	--	--	Install metal inlet marker on existing CPP.
	5.594	--	--	--	--	--	--	--	--	--	--	--	--	--	--	--	Install metal inlet marker on existing CPP.
	5.704	--	--	--	--	--	--	--	--	--	--	--	--	--	--	--	Install metal inlet marker on existing CPP.
	5.782	--	--	--	--	--	--	--	--	--	--	--	--	--	--	--	Install metal inlet marker on existing CMP.
	5.848	--	--	--	--	--	--	--	--	--	--	--	--	--	--	--	Install metal inlet marker on existing CPP.
	5.995	--	--	--	--	--	--	--	--	--	--	--	--	--	--	--	Install metal inlet marker on existing CPP.
	6.189	--	--	--	--	--	--	--	--	--	--	--	--	--	--	--	Install metal inlet marker on existing CPP.
	6.615	--	--	--	--	--	--	--	--	--	--	--	--	--	--	--	Install metal inlet marker on existing CPP.
	6.715	--	--	--	--	--	--	--	--	--	--	--	--	--	--	--	Install metal inlet marker on existing CPP.
	6.742	--	--	--	--	--	--	--	--	--	--	--	--	--	--	--	Install metal inlet marker on existing CPP.
	6.816	--	--	--	--	--	--	--	--	--	--	--	--	--	--	--	Install metal inlet marker on existing CPP.
	6.856	--	--	--	--	--	--	--	--	--	--	--	--	--	--	--	Install metal inlet marker on existing CPP.
	6.954	18"	--	60'	--	--	--	--	--	--	--	--	--	--	--	--	Install New Culvert as marked in field and directed by Authorized Officer. Place 25 CY 1-1/2"-0" Crushed Bedding/Backfill Rock. Spread 25 CY 4"-0" Crushed Base Rock over Pipe for Surfacing capped with 20 CY 1-1/2"-0" Crushed Rock. Install metal inlet marker.
	7.101	--	--	--	--	--	--	--	--	--	--	--	--	--	--	--	Install metal inlet marker on existing CPP.
	7.137	--	--	--	--	--	--	--	--	--	--	--	--	--	--	--	Install metal inlet marker on existing CPP.
	7.412	--	--	--	--	--	--	--	--	--	--	--	--	--	--	--	Install metal inlet marker on existing CPP.
	7.474	--	--	--	--	--	--	--	--	--	--	--	--	--	--	--	Install metal inlet marker on existing CMP.
	7.578	--	--	--	--	--	--	--	--	--	--	--	--	--	--	--	Install metal inlet marker on existing CPP.
2-5-29.1 (Fairchild Rd)	0.048	18"	--	40'	--	--	--	--	--	--	--	--	--	--	--	--	Install New Culvert as marked in field and directed by Authorized Officer. Place 20 CY 1-1/2"-0" Crushed Bedding/Backfill Rock. Spread 20 CY 4"-0" Crushed Base Rock over Pipe for Surfacing capped with a lift of rock spread on road. Install metal inlet marker.
	0.075	--	--	--	--	--	--	--	--	--	--	--	--	--	--	--	Install metal inlet marker on existing CMP.
	0.129	--	--	--	--	--	--	--	--	--	--	--	--	--	--	--	Install metal inlet marker on existing CMP.
	0.204	18"	--	30'	--	--	--	--	--	--	--	--	--	--	--	--	Replace Existing Culvert as marked in field and directed by Authorized Officer. Place 10 CY 1-1/2"-0" Crushed Bedding/Backfill Rock. Spread 10 CY 4"-0" Crushed Base Rock over Pipe for Surfacing capped with a lift of rock spread on road. Install metal inlet marker.
	0.286	--	--	--	--	--	--	--	--	--	--	--	--	--	--	--	Install metal inlet marker on existing CMP.
	0.366	18"	--	30'	--	--	18"	1	10'	--	--	--	--	--	--	--	Install New Culvert and Downspout as marked in field and directed by Authorized Officer. Place 10 CY 1-1/2"-0" Crushed Bedding/Backfill Rock. Spread 10 CY 4"-0" Crushed Base Rock over Pipe for Surfacing capped with a lift of rock spread on road. Install metal inlet marker.

<table border="1"> <thead> <tr> <th colspan="3">Gage Chart</th> </tr> <tr> <th rowspan="2">Gage</th> <th colspan="2">Dec. Inches</th> </tr> <tr> <th>Steel</th> <th>Alum.</th> </tr> </thead> <tbody> <tr> <td>10</td> <td>.138</td> <td>.135</td> </tr> <tr> <td>12</td> <td>.109</td> <td>.105</td> </tr> <tr> <td>14</td> <td>.079</td> <td>.075</td> </tr> <tr> <td>16</td> <td>.064</td> <td>.060</td> </tr> </tbody> </table>	Gage Chart			Gage	Dec. Inches		Steel	Alum.	10	.138	.135	12	.109	.105	14	.079	.075	16	.064	.060	<p><b>1.</b> Designed culvert lengths and locations are approximate.</p> <p><b>*2.</b> all culverts have 2-2/3" x 1/2" unless otherwise noted.</p> <p><b>*4.</b> Downspout or Standpipe Types                      1) Full                      2) Half                      3) Flume                      *** Downspouts and stand pipes (under 36" diameter) shall be CPP, Type C (single wall).</p> <p><b>*5.</b> 1) Conventional or Fabricated                      2) Turner type                      3) Slip joint</p> <p><b>*6.</b> Include special sections, structures, headwalls, footings &amp; other data.</p> <p>**** Corrugated plastic pipe (CPP), Type S (double wall) shall be used for culvert sizes 36" and smaller. All larger culverts shall be aluminized steel. Culverts 20' in length or smaller shall be one piece (no joints). No Culvert piece shall be shorter than 6 foot. Minimization of banding is required.</p>
	Gage Chart																				
	Gage	Dec. Inches																			
		Steel	Alum.																		
	10	.138	.135																		
12	.109	.105																			
14	.079	.075																			
16	.064	.060																			

**Culvert List**

CULVERT LOCATIONS							DOWNSPOUT(d) or STANDPIPE(s) *4				AS BUILT			ROCK			REMARKS *6
DESIGNED *2														RIP RAP (GRADING)			
														(a) (b)			
Road #	Sta./ M.P	SIZE	GAGE	LENGTH	CULVERT GRADE	INSTALL TYPE *3	SIZE	TYPE	LENGTH	TYPE OF ELBOW *5	SIZE	GAGE	LENGTH	INLET	OUTLET	Structure inside pipe	
2-5-29.1 (Fairchild Rd)	0.446	--	--	--	--	--	--	--	--	--	--	--	--	--	--	--	Install metal inlet marker on existing CMP.
	0.471	--	--	--	--	--	--	--	--	--	--	--	--	--	--	--	Construct a lead-off ditch. Install metal inlet marker on existing CMP.
	0.540	--	--	--	--	--	--	--	--	--	--	--	--	--	--	--	Install metal inlet marker on existing CMP.
	0.616	--	--	--	--	--	--	--	--	--	--	--	--	--	--	--	Re-install existing metal downspout. Install metal inlet marker on existing CMP.
	0.628	--	--	--	--	--	--	--	--	--	--	--	--	--	--	--	Re-install existing metal downspout.
	0.805	--	--	--	--	--	--	--	--	--	--	--	--	--	--	--	Existing Catch Basin is too deep, fix with compacted native material. Install metal inlet marker on existing CMP.
	0.855	--	--	--	--	--	--	--	--	--	--	--	--	--	--	--	Install metal inlet marker on existing CMP.
	0.942	--	--	--	--	--	--	--	--	--	--	--	--	--	--	--	Install metal inlet marker on existing CMP.
	0.990	--	--	--	--	--	--	--	--	--	--	--	--	--	--	--	Install metal inlet marker on existing CMP.
	1.029	--	--	--	--	--	--	--	--	--	--	--	--	--	--	--	Install metal inlet marker on existing CMP.
	1.082	--	--	--	--	--	--	--	--	--	--	--	--	--	--	--	Install metal inlet marker on existing CMP.
	1.116	--	--	--	--	--	--	--	--	--	--	--	--	20	--	--	Place 20 CY Class 5 RipRap @ outlet for fill armor/dissipater. Replace metal inlet marker on existing CMP.
	1.280	--	--	--	--	--	--	--	--	--	--	--	--	--	--	--	Install metal inlet marker on existing CMP.
	1.321	--	--	--	--	--	--	--	--	--	--	--	--	--	--	--	Install metal inlet marker on existing CMP.
	1.365	--	--	--	--	--	--	--	--	--	--	--	--	--	--	--	Install metal inlet marker on existing CMP.
	1.471	--	--	--	--	--	--	--	--	--	--	--	--	--	--	--	Install metal inlet marker on existing CMP.
	1.510	--	--	--	--	--	--	--	--	--	--	--	--	--	--	--	Install metal inlet marker on existing CMP.
	1.596	--	--	--	--	--	--	--	--	--	--	--	--	--	--	--	Install metal inlet marker on existing CMP.
	1.646	--	--	--	--	--	--	--	--	--	--	--	--	--	--	--	Install metal inlet marker on existing CMP.
	1.695	--	--	--	--	--	--	--	--	--	--	--	--	--	--	--	Excavate catch basin to fix buried existing CMP. Install metal inlet marker on existing CMP.
	1.734	--	--	--	--	--	--	--	--	--	--	--	--	--	--	--	Install metal inlet marker on existing CMP.
	1.806	18"	--	40'	--	--	18"	1	10'	--	--	--	--	--	--	--	Install New Culvert and Downspout as marked in field and directed by Authorized Officer. Place 20 CY 1-1/2"-0" Crushed Bedding/Backfill Rock. Spread 20 CY 4"-0" Crushed Base Rock over Pipe for Surfacing capped with a lift of rock spread on road. Install metal inlet marker.
	1.852	--	--	--	--	--	--	--	--	--	--	--	20	--	--	--	Place 20 CY Class 5 RipRap @ overflow inlet to widen road to the right. Spread 20 CY 4"-0" Crushed Base Rock on newly widened portion of road. Install 2 metal inlet markers.
	1.889	18"	--	40'	--	--	18"	1	10'	--	--	--	--	--	--	--	Install New Culvert and Downspout as marked in field and directed by Authorized Officer. Place 20 CY 1-1/2"-0" Crushed Bedding/Backfill Rock. Spread 20 CY 4"-0" Crushed Base Rock over Pipe for Surfacing capped with a lift of rock spread on road. Install metal inlet marker.
	2.085	--	--	--	--	--	--	--	--	--	--	--	--	--	--	--	Install metal inlet marker on existing CMP.
	2.157	--	--	--	--	--	--	--	--	--	--	--	--	--	--	--	Install metal inlet marker on existing CMP.
	2.232	--	--	--	--	--	--	--	--	--	--	--	--	--	--	--	Install metal inlet marker on existing CMP.
	2.303	--	--	--	--	--	--	--	--	--	--	--	--	--	--	--	Install metal inlet marker on existing CMP.

<table border="1"> <thead> <tr><th colspan="3">Gage Chart</th></tr> <tr><th rowspan="2">Gage</th><th colspan="2">Dec. Inches</th></tr> <tr><th>Steel</th><th>Alum.</th></tr> </thead> <tbody> <tr><td>10</td><td>.138</td><td>.135</td></tr> <tr><td>12</td><td>.109</td><td>.105</td></tr> <tr><td>14</td><td>.079</td><td>.075</td></tr> <tr><td>16</td><td>.064</td><td>.060</td></tr> </tbody> </table>			Gage Chart			Gage	Dec. Inches		Steel	Alum.	10	.138	.135	12	.109	.105	14	.079	.075	16	.064	.060	<p>1. Designed culvert lengths and locations are approximate.</p> <p>*2. all culverts have 2-2/3" x 1/2" unless otherwise noted.</p> <p>**** Corrugated plastic pipe (CPP), Type S (double wall) shall be used for culvert sizes 36" and smaller. All larger culverts shall be aluminized steel. Culverts 20' in length or smaller shall be one piece (no joints). No Culvert piece shall be shorter than 6 foot. Minimization of banding is required.</p>	<p>*4. Downspout or Standpipe Types</p> <p>1) Full *** Downspouts and stand pipes (under 36" diameter) shall be CPP, Type C (single wall).</p> <p>2) Half</p> <p>3) Flume</p>	<p>*5. 1) Conventional or Fabricated 2) Turner type 3) Slip joint</p> <p>*6. Include special sections, structures, headwalls, footings &amp; other data.</p>
Gage Chart																									
Gage	Dec. Inches																								
	Steel	Alum.																							
10	.138	.135																							
12	.109	.105																							
14	.079	.075																							
16	.064	.060																							

**Culvert List**

CULVERT LOCATIONS											ROCK			REMARKS *6			
DESIGNED *2							DOWNSPOUT(d) or STANDPIPE(s) *4				AS BUILT				RIP RAP (GRADING)		
Road #	Sta./ M.P	SIZE	GAGE	LENGTH	CULVERT GRADE	INSTALL TYPE *3	SIZE	TYPE	LENGTH	TYPE OF ELBOW *5	SIZE	GAGE	LENGTH		(a) INLET	(b) OUTLET	Structure inside pipe
2-6-3.0	0.006	--	--	--	--	--	--	--	--	--	--	--	--	--	--	--	Excavate to fix buried inlet and outlet. Install metal inlet marker on existing CPP.
	0.029	--	--	--	--	--	--	--	--	--	--	--	--	--	--	--	Install metal inlet marker on existing CPP.
	0.061	--	--	--	--	--	--	--	--	--	--	--	--	--	--	--	Install metal inlet marker on existing CMP.
	0.118	--	--	--	--	--	--	--	--	--	--	--	--	--	--	--	Install metal inlet marker on existing CMP.
	0.162	--	--	--	--	--	--	--	--	--	--	--	--	--	--	--	Install metal inlet marker on existing CMP.
	0.253	--	--	--	--	--	--	--	--	--	--	--	--	--	--	--	Install metal inlet marker on existing CMP.
	0.356	--	--	--	--	--	--	--	--	--	--	--	--	--	--	--	Install metal inlet marker on existing CMP.
	0.458	--	--	--	--	--	--	--	--	--	--	--	--	--	--	--	Install metal inlet marker on existing CMP.
	0.522	--	--	--	--	--	--	--	--	--	--	--	--	--	--	--	Install metal inlet marker on existing CMP.
2-6-9.1	0.110	--	--	--	--	--	--	--	--	--	--	--	--	--	--	--	Install metal inlet marker on existing CMP.
	0.138	--	--	--	--	--	--	--	--	--	--	--	--	--	--	--	Replace metal inlet marker on existing CMP.
	0.204	--	--	--	--	--	--	--	--	--	--	--	--	--	--	--	Install metal inlet marker on existing CMP.
	0.338	--	--	--	--	--	--	--	--	--	--	--	--	10	--	--	Place 10 CY Class 5 RipRap @ outlet for fill armor/dissipater. Install metal inlet marker on existing CMP.
	0.354	--	--	--	--	--	--	--	--	--	--	--	--	10	--	--	Place 10 CY Class 5 RipRap @ outlet for fill armor/dissipater. Install metal inlet marker on existing CMP.
	0.444	--	--	--	--	--	--	--	--	--	--	--	--	--	--	--	Re-install existing metal downspout. Install metal inlet marker on existing CMP.
	0.510	--	--	--	--	--	--	--	--	--	--	--	--	--	--	--	Install metal inlet marker on existing CMP.
	0.589	18"	--	50'	--	--	--	--	--	--	--	--	--	--	--	--	Install New Culvert as marked in field and directed by Authorized Officer. Place 20 CY 1-1/2"-0" Crushed Bedding/Backfill Rock. Spread 20 CY 4"-0" Crushed Base Rock over Pipe for Surfacing capped with 15 CY 1-1/2"-0" Crushed Rock.
	0.606	--	--	--	--	--	--	--	--	--	--	--	--	10	--	--	Place 10 CY Class 5 RipRap by hand @ outlet for dissipater. Install metal inlet marker on existing CMP.
	0.621	18"	--	40'	--	--	18"	1	10'	--	--	--	--	--	--	--	Install New Culvert and Downspout as marked in field and directed by Authorized Officer. Place 20 CY 1-1/2"-0" Crushed Bedding/Backfill Rock. Spread 20 CY 4"-0" Crushed Base Rock over Pipe for Surfacing capped with 15 CY 1-1/2"-0" Crushed Rock. Install metal inlet marker.
	0.710	--	--	--	--	--	--	--	--	--	--	--	--	--	--	--	Install metal inlet marker on existing CMP.
	0.755	--	--	--	--	--	--	--	--	--	--	--	--	--	--	--	Install metal inlet marker on existing CMP.
	0.855	24"	--	40'	--	--	--	--	--	--	--	--	--	--	--	--	Salvage 10' of existing 24" CPP. Replace Existing Culvert as marked in field and directed by Authorized Officer. Place 20 CY 1-1/2"-0" Crushed Bedding/Backfill Rock. Spread 20 CY 4"-0" Crushed Base Rock over Pipe as Surfacing capped with 15 CY 1-1/2"-0" Crushed Rock. Install metal inlet marker.
	0.872	18"	--	40'	--	--	--	--	--	--	--	--	--	--	--	--	Install New Culvert as marked in field and directed by Authorized Officer. Place 20 CY 1-1/2"-0" Crushed Bedding/Backfill Rock. Spread 20 CY 4"-0" Crushed Base Rock over Pipe for Surfacing capped with 15 CY 1-1/2"-0" Crushed Rock. Install metal inlet marker.

<table border="1"> <thead> <tr> <th colspan="3">Gage Chart</th> </tr> <tr> <th rowspan="2">Gage</th> <th colspan="2">Dec. Inches</th> </tr> <tr> <th>Steel</th> <th>Alum.</th> </tr> </thead> <tbody> <tr> <td>10</td> <td>.138</td> <td>.135</td> </tr> <tr> <td>12</td> <td>.109</td> <td>.105</td> </tr> <tr> <td>14</td> <td>.079</td> <td>.075</td> </tr> <tr> <td>16</td> <td>.064</td> <td>.060</td> </tr> </tbody> </table>	Gage Chart			Gage	Dec. Inches		Steel	Alum.	10	.138	.135	12	.109	.105	14	.079	.075	16	.064	.060	<p>1. Designed culvert lengths and locations are approximate.</p> <p>*2. all culverts have 2-2/3" x 1/2" unless otherwise noted.</p> <p>**** Corrugated plastic pipe (CPP), Type S (double wall) shall be used for culvert sizes 36" and smaller. All larger culverts shall be aluminized steel. Culverts 20' in length or smaller shall be one piece (no joints). No Culvert piece shall be shorter than 6 foot. Minimization of banding is required.</p>	<p>*4. Downspout or Standpipe Types</p> <p>1) Full      *** Downspouts and stand pipes (under 36" diameter) shall be CPP, Type C (single wall).</p> <p>2) Half</p> <p>3) Flume</p>	<p>*5. 1) Conventional or Fabricated 2) Turner type 3) Slip joint</p> <p>*6. Include special sections, structures, headwalls, footings &amp; other data.</p>
	Gage Chart																						
	Gage	Dec. Inches																					
		Steel	Alum.																				
	10	.138	.135																				
12	.109	.105																					
14	.079	.075																					
16	.064	.060																					

**Culvert List**

CULVERT LOCATIONS							DOWNSPOUT(d) or STANDPIPE(s) *4				AS BUILT			ROCK			REMARKS *6
DESIGNED *2														RIP RAP (GRADING)			
Road #	Sta./ M.P	SIZE	GAGE	LENGTH	CULVERT GRADE	INSTALL TYPE *3	SIZE	TYPE	LENGTH	TYPE OF ELBOW *5	SIZE	GAGE	LENGTH	INLET	OUTLET	Structure inside pipe	
2-6-10.1	1+96	18"	--	50'	--	--	--	--	--	--	--	--	--	--	--	--	Install New Culvert as marked in field and directed by Authorized Officer (approx. 11' fill @ CL). Place 20 CY 1-1/2"-0" Crushed Bedding/Backfill Rock. Surface with lifts of rock spread on road. Install metal inlet marker.
	5+89	18"	--	40'	--	--	--	--	--	--	--	--	--	--	--	--	Install New Culvert as marked in field and directed by Authorized Officer. Place 20 CY 1-1/2"-0" Crushed Bedding/Backfill Rock. Surface with lifts of rock spread on road. Install metal inlet marker.
	9+52	18"	--	30'	--	--	--	--	--	--	--	--	--	--	--	--	Install New Culvert as marked in field and directed by Authorized Officer. Place 10 CY 1-1/2"-0" Crushed Bedding/Backfill Rock. Surface with lifts of rock spread on road. Install metal inlet marker.
	12+70	18"	--	40'	--	--	--	--	--	--	--	--	--	--	--	--	Install New Culvert as marked in field and directed by Authorized Officer. Place 20 CY 1-1/2"-0" Crushed Bedding/Backfill Rock. Surface with lifts of rock spread on road. Install metal inlet marker.
	15+12	18"	--	30'	--	--	--	--	--	--	--	--	--	--	--	--	Install New Culvert as marked in field and directed by Authorized Officer. Place 10 CY 1-1/2"-0" Crushed Bedding/Backfill Rock. Surface with lifts of rock spread on road. Install metal inlet marker.
2-6-10.3	3+41	18"	--	40'	--	--	--	--	--	--	--	--	--	--	--	--	Install New Culvert as marked in field and directed by Authorized Officer. Place 20 CY 1-1/2"-0" Crushed Bedding/Backfill Rock. Surface with lifts of rock spread on road. Install metal inlet marker.
2-6-11.0	16+59	18"	--	40'	--	--	--	--	--	--	--	--	--	--	--	--	Install New Culvert with lead-off ditch as marked in field and directed by Authorized Officer. Place 20 CY 1-1/2"-0" Crushed Bedding/Backfill Rock. Surface with lifts of rock spread on road. Install metal inlet marker.
	40+21	18"	--	40'	--	--	--	--	--	--	--	--	--	--	--	--	Install New Culvert as marked in field and directed by Authorized Officer. Place 20 CY 1-1/2"-0" Crushed Bedding/Backfill Rock. Surface with lifts of rock spread on road. Install metal inlet marker.
	43+46	18"	--	40'	--	--	--	--	--	--	--	--	--	--	--	--	Install New Culvert as marked in field and directed by Authorized Officer. Place 20 CY 1-1/2"-0" Crushed Bedding/Backfill Rock. Surface with lifts of rock spread on road. Install metal inlet marker.
	44+60	18"	--	30'	--	--	--	--	--	--	--	--	--	--	--	--	Install New Culvert as marked in field and directed by Authorized Officer. Place 10 CY 1-1/2"-0" Crushed Bedding/Backfill Rock. Surface with lifts of rock spread on road.
2-6-11.1	3+12	18"	--	50'	--	--	--	--	--	--	--	--	--	--	--	--	Install New Culvert with lead-off ditch as marked in field and directed by Authorized Officer. Place 20 CY 1-1/2"-0" Crushed Bedding/Backfill Rock. Surface with lifts of rock spread on road. Install metal inlet marker.
	5+34	18"	--	40'	--	--	--	--	--	--	--	--	--	--	--	--	Install New Culvert as marked in field and directed by Authorized Officer. Place 20 CY 1-1/2"-0" Crushed Bedding/Backfill Rock. Surface with lifts of rock spread on road. Install metal inlet marker.
	9+89	18"	--	60'	--	--	--	--	--	--	--	--	--	--	--	--	Install New Culvert as marked in field and directed by Authorized Officer. Place 25 CY 1-1/2"-0" Crushed Bedding/Backfill Rock. Surface with lifts of rock spread on road. Install metal inlet marker.
	12+75	18"	--	40'	--	--	--	--	--	--	--	--	--	--	--	--	Install New Culvert as marked in field and directed by Authorized Officer. Place 20 CY 1-1/2"-0" Crushed Bedding/Backfill Rock. Surface with lifts of rock spread on road. Install metal inlet marker.
	16+38	18"	--	40'	--	--	--	--	--	--	--	--	--	--	--	--	Install New Culvert as marked in field and directed by Authorized Officer. Place 20 CY 1-1/2"-0" Crushed Bedding/Backfill Rock. Surface with lifts of rock spread on road. Install metal inlet marker.
	17+51	36"	--	70'	--	--	--	--	--	--	--	--	--	30	65	--	Stream. Replace Existing Culvert as marked in the field and directed by Authorized Officer (approx. 14' fill @ CL). Place 40 CY 1-1/2"-0" Crushed Bedding/Backfill Rock. Surface with lifts of rock spread on road. Place 30 CY Class 5 RipRap @ inlet for fill armor. Place 65 CY Class 5 RipRap @ outlet as fill armor/dissipater. Install metal inlet marker.

Gage Chart		
Gage	Dec. Inches	
	Steel	Alum.
10	.138	.135
12	.109	.105
14	.079	.075
16	.064	.060

1. Designed culvert lengths and locations are approximate.

\*2. all culverts have 2-2/3" x 1/2"

unless otherwise noted.

\*\*\*\* Corrugated plastic pipe (CPP), Type S (double wall) shall be used for culvert sizes 36" and smaller. All larger culverts shall be aluminized steel. Culverts 20' in length or smaller shall be one piece (no joints). No Culvert piece shall be shorter than 6 foot. Minimization of banding is required.

\*4. Downspout or Standpipe Types

- 1) Full
  - 2) Half
  - 3) Flume
- \*\*\* Downspouts and stand pipes (under 36" diameter) shall be CPP, Type C (single wall).

\*5. 1) Conventional or Fabricated  
2) Turner type  
3) Slip joint

\*6. Include special sections, structures, headwalls, footings & other data.

**Culvert List**

CULVERT LOCATIONS							DOWNSPOUT(d) or STANDPIPE(s) *4				AS BUILT			ROCK			REMARKS *6
DESIGNED *2														RIP RAP (GRADING)			
Road #	Sta./ M.P	SIZE	GAGE	LENGTH	CULVERT GRADE	INSTALL TYPE *3	SIZE	TYPE	LENGTH	TYPE OF ELBOW *5	SIZE	GAGE	LENGTH	(a) INLET	(b) OUTLET	Structure inside pipe	
2-6-11.1	18+69	24"	--	60'	--	--	--	--	--	--	--	--	--	10	40	--	Stream. Install New Culvert as marked in the field and directed by Authorized Officer (approx. 14' fill @ CL). Place 25 CY 1-1/2"-0" Crushed Bedding/Backfill Rock. Surface with lifts of rock spread on road. Place 10 CY Class 5 RipRap @ inlet for fill armor. Place 40 CY Class 5 RipRap @ outlet as fill armor/dissipater. Install metal inlet marker. Excavate a stream channel from the culvert inlet up the hill to the existing road to divert stream into newly excavated stream bed.
	24+54	18"	--	40'	--	--	--	--	--	--	--	--	--	--	--	--	Install New Culvert as marked in field and directed by Authorized Officer. Place 20 CY 1-1/2"-0" Crushed Bedding/Backfill Rock. Surface with lifts of rock spread on road. Install metal inlet marker.
	28+74	18"	--	40'	--	--	--	--	--	--	--	--	--	--	--	--	Install New Culvert as marked in field and directed by Authorized Officer. Place 20 CY 1-1/2"-0" Crushed Bedding/Backfill Rock. Surface with lifts of rock spread on road. Install metal inlet marker.
	31+78	--	--	--	--	--	--	--	--	--	--	--	--	--	100	--	Construct a Free-draining fill as marked in the field and directed by Authorized Officer. Place 150 CY 1-1/2"-3/4" Drain Rock as backfill wrapped with 200 SY of non-woven geo-synthetic fabric. Place 100 CY Class 5 RipRap on fill slope for fill armor.
	32+83	18"	--	40'	--	--	--	--	--	--	--	--	--	--	--	--	Install New Culvert as marked in field and directed by Authorized Officer. Place 20 CY 1-1/2"-0" Crushed Bedding/Backfill Rock. Surface with lifts of rock spread on road. Install metal inlet marker.
	34+33	36"	--	70'	--	--	--	--	--	--	--	--	--	10	30	--	Stream. Install New Culvert as marked in the field and directed by Authorized Officer (approx. 8' fill @ CL). Place 40 CY 1-1/2"-0" Crushed Bedding/Backfill Rock. Surface with lifts of rock spread on road. Place 10 CY Class 5 RipRap @ inlet for fill armor. Place 30 CY Class 5 RipRap @ outlet as fill armor/dissipater. Install metal inlet marker.
	37+62	18"	--	30'	--	--	18"	1	10'	--	--	--	--	--	--	--	Install New Culvert and Downspout as marked in field and directed by Authorized Officer. Place 10 CY 1-1/2"-0" Crushed Bedding/Backfill Rock. Surface with lifts of rock spread on road. Install metal inlet marker.
	41+43	18"	--	30'	--	--	18"	1	10'	--	--	--	--	--	--	--	Install New Culvert and Downspout as marked in field and directed by Authorized Officer. Place 10 CY 1-1/2"-0" Crushed Bedding/Backfill Rock. Surface with lifts of rock spread on road. Install metal inlet marker.
2-6-11.2	0+31	18"	--	50'	--	--	--	--	--	--	--	--	--	--	--	--	Install New Culvert that disconnects ditch from 2-6-11.2 and 2-6-15.4 as marked in the field and directed by Authorized Officer. Place 20 CY 1-1/2"-0" Crushed Bedding/Backfill Rock.
2-6-12.1	0.035	--	--	--	--	--	--	--	--	--	--	--	--	--	--	--	Install metal inlet marker on existing CPP.
	0.320	--	--	--	--	--	--	--	--	--	--	--	--	--	--	--	Construct a lead-off ditch. Install metal inlet marker on existing CPP.
	0.387	18"	--	70'	--	--	--	--	--	--	--	--	--	--	--	--	Install New Culvert as marked in field and directed by Authorized Officer. Place 30 CY 1-1/2"-0" Crushed Bedding/Backfill Rock. Spread 30 CY 4"-0" Crushed Base Rock over Pipe for Surfacing capped with 25 CY 1-1/2"-0" Crushed Rock. Install metal inlet marker.
	0.627	18"	--	40'	--	--	--	--	--	--	--	--	--	--	--	--	Install New Culvert as marked in field and directed by Authorized Officer. Place 20 CY 1-1/2"-0" Crushed Bedding/Backfill Rock. Spread 20 CY 4"-0" Crushed Base Rock over Pipe for Surfacing capped with 15 CY 1-1/2"-0" Crushed Rock. Install metal inlet marker.
	0.663	24"	--	30'	--	--	--	--	--	--	--	--	--	--	--	--	Stream. Replace Existing Culvert as marked in the field and directed by Authorized Officer. Place 15 CY 1-1/2"-0" Crushed Bedding/Backfill Rock. Spread 15 CY 4"-0" Crushed Base Rock over Pipe for Surfacing capped with 10 CY 1-1/2"-0" Crushed Rock. Install metal inlet marker.

Gage Chart		
Gage	Dec. Inches	
	Steel	Alum.
10	.138	.135
12	.109	.105
14	.079	.075
16	.064	.060

1. Designed culvert lengths and locations are approximate.

\*2. all culverts have 2-2/3" x 1/2"

unless otherwise noted.

\*\*\*\* Corrugated plastic pipe (CPP), Type S (double wall) shall be used for culvert sizes 36" and smaller. All larger culverts shall be aluminized steel. Culverts 20' in length or smaller shall be one piece (no joints). No Culvert piece shall be shorter than 6 foot. Minimization of banding is required.

\*4. Downspout or Standpipe Types

- 1) Full \*\*\* Downspouts and stand pipes (under 36" diameter) shall be CPP, Type C (single wall).
- 2) Half
- 3) Flume

\*5. 1) Conventional or Fabricated  
2) Turner type  
3) Slip joint

\*6. Include special sections, structures, headwalls, footings & other data.

**Culvert List**

CULVERT LOCATIONS							DOWNSPOUT(d) or STANDPIPE(s) *4				AS BUILT			ROCK			REMARKS *6
DESIGNED *2														RIP RAP (GRADING)			
Road #	Sta./ M.P	SIZE	GAGE	LENGTH	CULVERT GRADE	INSTALL TYPE *3	SIZE	TYPE	LENGTH	TYPE OF ELBOW *5	SIZE	GAGE	LENGTH	INLET	OUTLET	Structure inside pipe	
2-6-14.0	9+15	18"	--	30'	--	--	18"	1	10'	--	--	--	--	--	--	--	Install New Culvert and Downspout as marked in field and directed by Authorized Officer. Place 10 CY 1-1/2"-0" Crushed Bedding/Backfill Rock. Spread 10 CY 4"-0" Crushed Base Rock over Pipe for Surfacing capped with 10 CY 1-1/2"-0" Crushed Rock. Install metal inlet marker.
	12+45	--	--	--	--	--	--	--	--	--	--	--	--	5	--	--	Place 5 CY Class 3 RipRap @ inlet for fill armor. Install metal inlet marker on existing CPP.
	16+46	18"	--	60'	--	--	--	--	--	--	--	--	--	--	--	--	Install New Culvert as marked in field and directed by Authorized Officer. Place 25 CY 1-1/2"-0" Crushed Bedding/Backfill Rock. Spread 25 CY 4"-0" Crushed Base Rock over Pipe as Surfacing capped with 20 CY 1-1/2"-0" Crushed Rock. Install metal inlet marker. Remove existing waste pile @ outlet.
	19+98	--	--	--	--	--	--	--	--	--	--	--	--	--	--	--	Install metal inlet marker on existing CPP.
2-6-14.2	6+23	--	--	--	--	--	--	--	--	--	--	--	--	--	--	--	Install metal inlet marker on existing CPP.
	20+69	18"	--	40'	--	--	--	--	--	--	--	--	--	--	--	--	Install New Culvert as marked in field and directed by Authorized Officer. Place 20 CY 1-1/2"-0" Crushed Bedding/Backfill Rock. Surface with lifts of rock spread on road. Install metal inlet marker.
2-6-14.3	0+24	18"	--	60'	--	--	--	--	--	--	--	--	--	--	--	--	Install New Culvert and lead-off ditch as marked in field and directed by Authorized Officer. Place 25 CY 1-1/2"-0" Crushed Bedding/Backfill Rock. Surface with lifts of rock spread on road.
	3+06	18"	--	30'	--	--	--	--	--	--	--	--	--	--	--	--	Install New Culvert as marked in field and directed by Authorized Officer. Place 10 CY 1-1/2"-0" Crushed Bedding/Backfill Rock. Surface with lifts of rock spread on road. Install metal inlet marker.
	4+68	18"	--	40'	--	--	--	--	--	--	--	--	--	--	--	--	Install New Culvert as marked in field and directed by Authorized Officer. Place 20 CY 1-1/2"-0" Crushed Bedding/Backfill Rock. Surface with lifts of rock spread on road. Install metal inlet marker.
	8+72	18"	--	30'	--	--	18"	1	10'	--	--	--	--	--	--	--	Install New Culvert and Downspout as marked in field and directed by Authorized Officer. Place 10 CY 1-1/2"-0" Crushed Bedding/Backfill Rock. Surface with lifts of rock spread on road. Install metal inlet marker.
	11+51	18"	--	40'	--	--	--	--	--	--	--	--	--	--	10	--	Install New Culvert as marked in field and directed by Authorized Officer. Place 20 CY 1-1/2"-0" Crushed Bedding/Backfill Rock. Surface with lifts of rock spread on road. Place 10 CY Class 5 RipRap @ outlet as fill armor. Install metal inlet marker.
2-6-14.4	6+28	--	--	--	--	--	--	--	--	--	--	--	--	--	--	--	Construct lead-off ditch on existing CPP. Install metal inlet marker on existing CPP.
	9+21	--	--	--	--	--	--	--	--	--	--	--	--	--	--	--	Install metal inlet marker on existing CPP.
2-6-14.6	0+43	18"	--	50'	--	--	--	--	--	--	--	--	--	--	--	--	Install New Culvert as marked in field and directed by Authorized Officer. Place 20 CY 1-1/2"-0" Crushed Bedding/Backfill Rock. Surface with lifts of rock spread on road.
2-6-15.4	7+21	18"	--	40'	--	--	--	--	--	--	--	--	--	--	--	--	Install New Culvert as marked in field and directed by Authorized Officer. Place 20 CY 1-1/2"-0" Crushed Bedding/Backfill Rock. Surface with lifts of rock spread on road. Install metal inlet marker.
	10+73	18"	--	30'	--	--	18"	1	10'	--	--	--	--	--	--	--	Install New Culvert and Downspout as marked in field and directed by Authorized Officer. Place 10 CY 1-1/2"-0" Crushed Bedding/Backfill Rock. Surface with lifts of rock spread on road.

Gage Chart		
Gage	Dec. Inches	
	Steel	Alum.
10	.138	.135
12	.109	.105
14	.079	.075
16	.064	.060

1. Designed culvert lengths and locations are approximate.

\*2. all culverts have 2-2/3" x 1/2"

unless otherwise noted.

\*\*\*\* Corrugated plastic pipe (CPP), Type S (double wall) shall be used for culvert sizes 36" and smaller. All larger culverts shall be aluminized steel. Culverts 20' in length or smaller shall be one piece (no joints). No Culvert piece shall be shorter than 6 foot. Minimization of banding is required.

\*4. Downspout or Standpipe Types

- 1) Full \*\*\* Downspouts and stand pipes (under 36" diameter) shall be CPP, Type C (single wall).
- 2) Half
- 3) Flume

- \*5. 1) Conventional or Fabricated
- 2) Turner type
- 3) Slip joint

\*6. Include special sections, structures, headwalls, footings & other data.



U.S. DEPT. OF THE INTERIOR  
Bureau of Land Management  
NORTHWEST OREGON DISTRICT OFFICE - OREGON

**CULVERT BAND DETAILS**

NOTE:  
DESIGN VARIATIONS IN FASTENERS,  
(STRAPS, BARS & WELDS) WHICH  
PROVIDE A TENSILE STRENGTH OF  
7500 LBS. ARE PERMISSIBLE.

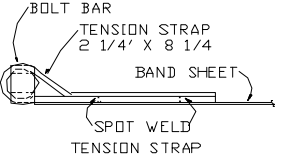

DETAIL A

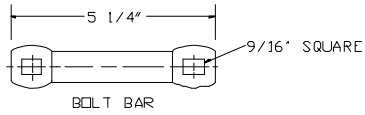
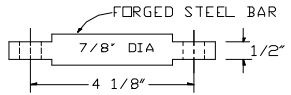

TENSION STRAP  
AND BOLT BAR.  
SEE DETAIL A

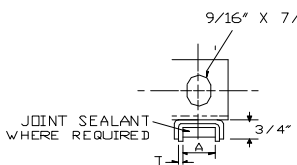
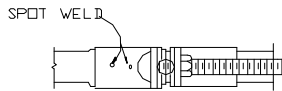
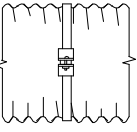
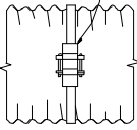

DIMENSIONS IN INCHES

T	A	PIPE WALL THICKNESS
.179	3/4	.109 OR LIGHTER
.109	1	.138 OR HEAVIER

SECTION A-A

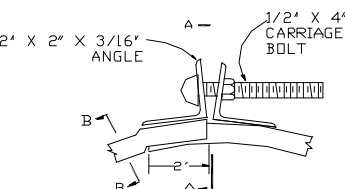

NOTE:  
AS AN ALTERNATE TO SWEDGE, AN  
OVERSIZE BRIDGE CLIP MAY BE USED.

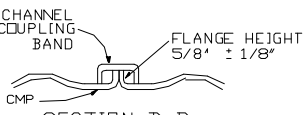

SECTION B-B

CHANNEL  
BAND  
COUPLER

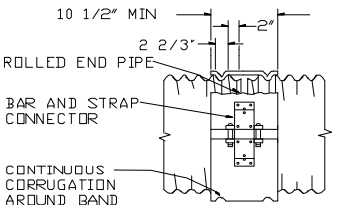

STANDARD CONSTRUCTION IS 1 PIECE 12'  
THRU 48" AND 2 PIECE 54" AND ABOVE

THE HUGGER COUPLER BAND OR AN APPROVED EQUIVALENT  
COUPLER BAND SHALL BE MADE OF THE SAME MATERIAL AND  
FINISH AS THE PIPES JOINED. THE COUPLER BANDS SHALL  
HAVE A MINIMUM WIDTH OF 10 1/2 INCHES AND MAY BE TWO  
NUMERICAL THICKNESSES LIGHTER THAN THE GAGE OR  
THICKNESS DESIGNATED FOR THE CONDUIT JOINED. THE BAND  
SHALL BE DESIGNED TO BE DRAWN TOGETHER WITH TWO  
1/2 INCH BOLTS THROUGH USE OF A BAR AND STRAP SUITABLY  
WELDED TO THE BAND. THE BAND SHALL ENGAGE AND MESH  
WITH THE SECOND ANNULAR CORRUGATION INWARD FROM  
THE END OF EACH OF THE CONDUIT SECTIONS JOINED.

GASKETS AND "HUGGER" TYPE BANDS, OR AN APPROVED  
EQUIVALENT COUPLER, SHALL BE INSTALLED  
INSTALLED ON ALL 48" AND LARGER METAL PIPES.

"HUGGER" COUPLER BANDS

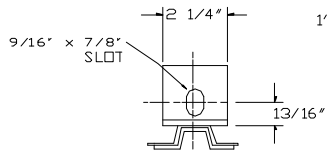

SECTION C-C

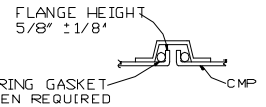
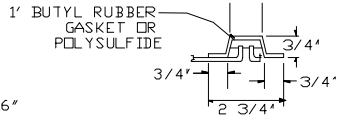
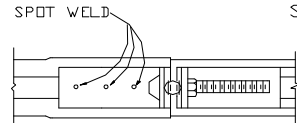

SECTION D-D

SHOWN WITH ALTERNATE TYPES  
OF JOINT SEALERS

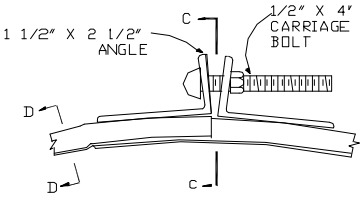
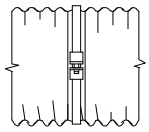

FLANGED END COUPLER

CULVERT SIZE INCHES	STANDARD COUPLER BANDS CORRUGATED							
	STD. ANNULAR		HELICAL		3' x 1'		6' x 1'	
	WIDTH	NO. OF BOLTS	WIDTH	NO. OF BOLTS	WIDTH	NO. OF BOLTS	WIDTH	NO. OF BOLTS
UNDER 18	7	2	7	2				
18 TO 54	12	3	12	3	14	3	18	3
OVER 54	24	5	24	5	24	5	24	4

DATA IN THIS BLOCK DOES NOT APPLY TO PERFORATED PIPE UNDERDRAIN.  
FOR BANDS WITH "PUNCH-OUT" TYPE CONNECTIONS, 2 BOLTS ARE  
PERMISSIBLE FOR EACH LAP. BANDS SHALL LAP 1/2 WIDTH ONTO EACH  
SECTION OF PIPE AND MUST FULLY ENCIRCLE THE JOINT FORMING A  
NEARLY WATERTIGHT CONNECTION.

- Ⓐ BANDS WITH ANGLES
- Ⓑ BANDS WITH TENSION TYPE CONNECTIONS

**U.S. DEPT. OF THE INTERIOR  
Bureau of Land Management  
NORTHWEST OREGON DISTRICT OFFICE - OREGON  
CULVERT INSTALLATION DETAILS**

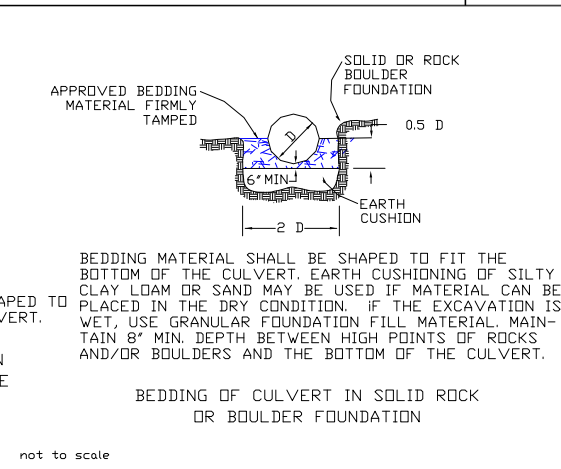
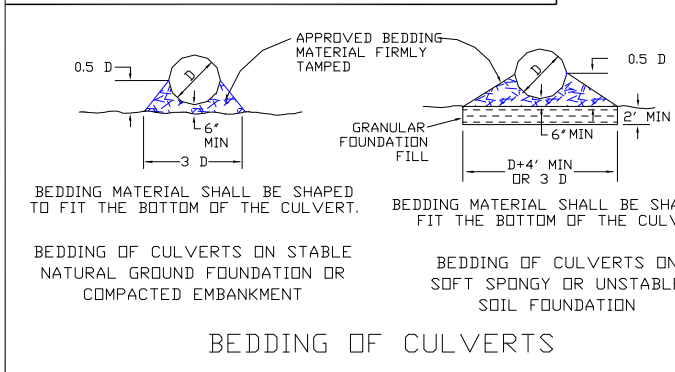
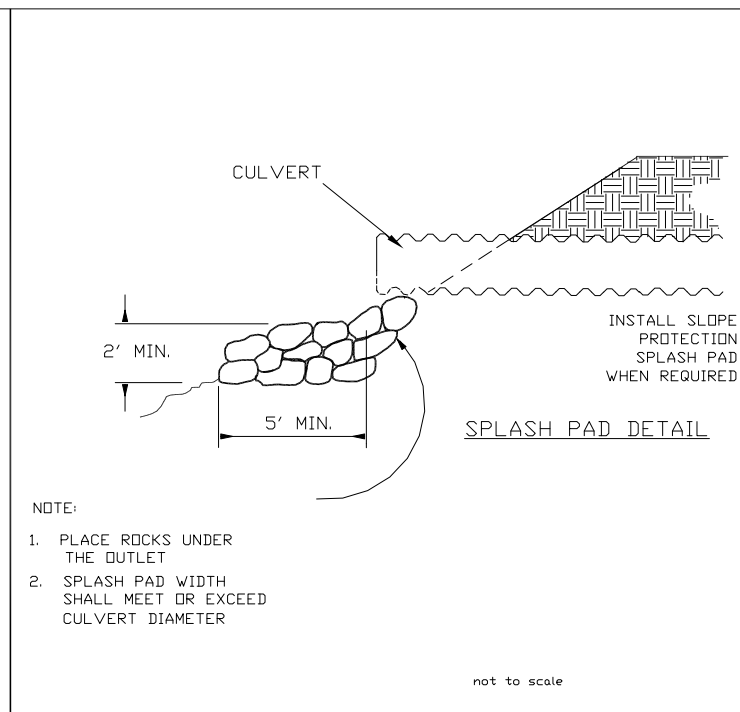
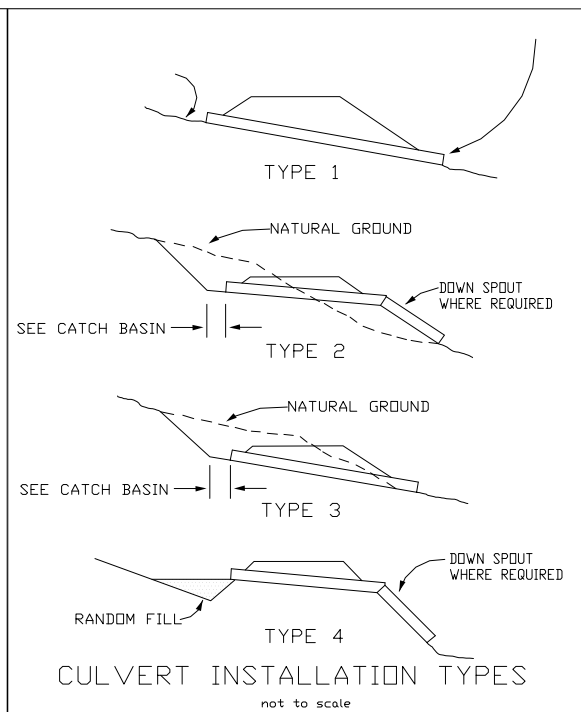
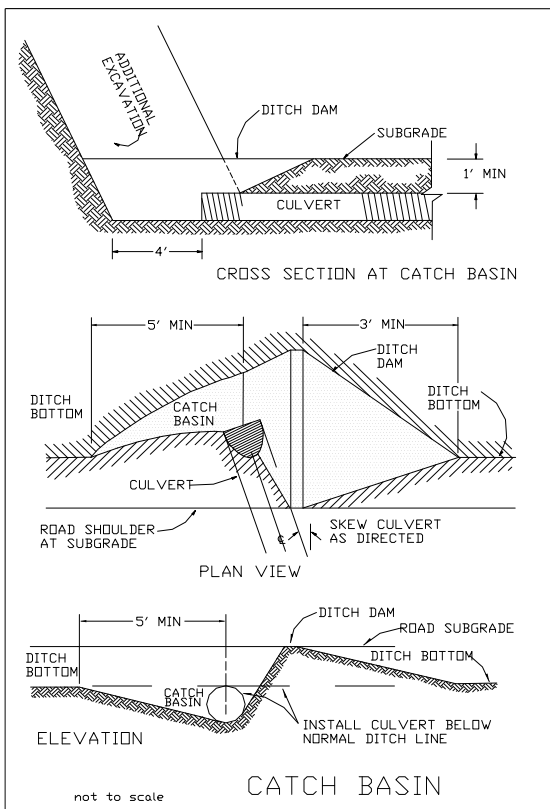

**ROCK VOLUMES TOTALS**

<b>ROAD SEGMENT:</b>			<b>2-5-10.0 (Turner Creek Road)</b>		<b>MILEAGE:</b>			<b>0.000 to 7.647</b>	
Application	Rock Size and Type	Location	Compacted Depth	Volume per Station/Item (CY)	Approx. Total (CY)	Curve Widening (CY)	Summary Totals		
Road Rock	1-1/2"-0"	Spot Rock	---	---	---	---	370		
Road Rock	4"-0"	Base Rock	---	---	---	---	80		
Culverts	1-1/2"-0"	Spot Rock	---	---	---	---	130		
Culverts	4"-0"	Base Rock	---	---	---	---	170		
Culverts	1-1/2"-0"	Bedding/Backfill	---	---	---	---	175		
Lined Ditch	Pitrun	MP (0.342 - 0.405), (1.923 - 1.941), (6.856 - 6.914)	---	---	---	---	110		
Fill Armor Inlet	RipRap: Class 5	MP 3.999	---	---	---	---	20		
Fill Armor/Dissipater Outlet	RipRap: Class 5	MP 4.370	---	---	---	---	40		

<b>ROAD SEGMENT:</b>			<b>2-5-29.1 (Fairchild Road)</b>		<b>MILEAGE:</b>			<b>0.000 to 2.375</b>	
Application	Rock Size and Type	Location	Compacted Depth	Volume per Station/Item (CY)	Approx. Total (CY)	Curve Widening (CY)	Summary Totals		
Road Rock	1-1/2"-0"	Cap Rock: 0.000 - 2.375	6"	30	3,762	454	4,216		
Road Rock	1-1/2"-0"	Spot Rock	---	---	---	---	180		
Road Rock	4"-0"	Base Rock	---	---	---	---	360		
Culverts	4"-0"	Base Rock	---	---	---	---	80		
Culverts	1-1/2"-0"	Bedding/Backfill	---	---	---	---	80		
Lined Ditch	Pitrun	MP (0.449 - 0.468), (0.475 - 0.506), (0.511 - 0.540), (0.616 - 0.637), (1.082 - 1.090), (1.116 - 1.122)	---	---	---	---	90		
Fill Armor Inlet	RipRap: Class 5	MP 1.852	---	---	---	---	20		
Fill Armor/Dissipater Outlet	RipRap: Class 5	MP 1.116	---	---	---	---	20		

<b>ROAD SEGMENT:</b>			<b>2-6-3.0</b>		<b>MILEAGE:</b>			<b>0.000 to 0.729</b>	
Application	Rock Size and Type	Location	Compacted Depth	Volume per Station/Item (CY)	Approx. Total (CY)	Curve Widening (CY)	Summary Totals		
Road Rock	1-1/2"-0"	Spot Rock	---	---	---	---	400		
Road Rock	4"-0"	Base Rock	---	---	---	---	80		

**ROCK VOLUMES TOTALS**

<b>ROAD SEGMENT: 2-6-9.1</b>			<b>STATION: 0.000 - 0.872</b>				
Application	Rock Size and Type	Location/Number	Compacted Depth	Volume per Station/Item (CY)	Approx. Total (CY)	Curve Widening (CY)	Summary Totals
Road Rock	1-1/2"-0"	Cap Rock: 0.646 - 0.847	6"	30	318	72	390
Road Rock	1-1/2"-0"	Spot Rock	---	---	---	---	440
Road Rock	4"-0"	Base Rock	---	---	---	---	120
Culverts	1-1/2"-0"	Spot Rock	---	---	---	---	60
Culverts	4"-0"	Base Rock	---	---	---	---	80
Culverts	1-1/2"-0"	Bedding/Backfill	---	---	---	---	80
Lined Ditch	Pitrun	MP (0.338 - 0.354)	---	---	---	---	15
Fill Armor/Dissipater Outlet	RipRap: Class 5	MP 0.338, 0.354, 0.606	---	---	---	---	30
Inlet Fill Slope Armor	RipRap: Class 5	MP MP 0.341	---	---	---	---	10

<b>ROAD SEGMENT: 2-6-10.1</b>			<b>STATION: 0+00 to 17+63</b>				
Application	Rock Size and Type	Location	Compacted Depth	Volume per Station/Item (CY)	Approx. Total (CY)	Curve Widening (CY)	Summary Totals
Road Rock	1-1/2"-0"	Cap Rock: 0+00 - 17+63	4"	19	335	56	391
Road Rock	4"-0"	Base Rock: 0+00 - 17+63	8"	40	705	139	844
Road Rock	1-1/2"-0"	Spot Rock	---	---	---	---	70
Road Rock	4"-0"	Base Rock	---	---	---	---	130
Culverts	1-1/2"-0"	Bedding/Backfill	---	---	---	---	80

<b>ROAD SEGMENT: 2-6-10.2</b>			<b>STATION: 0+00 to 1+62</b>				
Application	Rock Size and Type	Location/Number	Compacted Depth	Volume per Station/Item (CY)	Approx. Total (CY)	Curve Widening (CY)	Summary Totals
Road Rock	1-1/2"-0"	Cap Rock: 0+00 - 1+62	4"	19	31	3	34
Road Rock	4"-0"	Base Rock: 0+00 - 1+62	8"	40	65	9	74
Road Rock	1-1/2"-0"	Spot Rock	---	---	---	---	40
Road Rock	4"-0"	Base Rock	---	---	---	---	70

**ROCK VOLUMES TOTALS**

ROAD SEGMENT:		2-6-10.3	STATION: 0+00 to 4+38				
Application	Rock Size and Type	Location	Compacted Depth	Volume per Station/Item (CY)	Approx. Total (CY)	Curve Widening (CY)	Summary Totals
Road Rock	1-1/2"-0"	Cap Rock: 0+00 - 4+38	4"	19	83	11	94
Road Rock	4"-0"	Base Rock: 0+00 - 4+38	8"	40	175	29	204
Road Rock	1-1/2"-0"	Spot Rock	---	---	---	---	40
Road Rock	4"-0"	Base Rock	---	---	---	---	70
Culverts	1-1/2"-0"	Bedding/Backfill	---	---	---	---	20
Fill Slope Armor	RipRap: Class 5	Sta. 1+30 - 2+32	---	---	---	---	330

ROAD SEGMENT:		2-6-11.0	STATION: 0+00 to 45+79				
Application	Rock Size and Type	Location/Number	Compacted Depth	Volume per Station/Item (CY)	Approx. Total (CY)	Curve Widening (CY)	Summary Totals
Road Rock	1-1/2"-0"	Cap Rock: 0+00 - 45+79	4"	19	870	164	1,034
Road Rock	4"-0"	Base Rock: 0+00 - 15+43	6"	30	463	71	534
Road Rock	4"-0"	Base Rock: 15+43 - 45+79	8"	40	1,214	199	1,413
Road Rock	1-1/2"-0"	Spot Rock	---	---	---	---	120
Road Rock	4"-0"	Base Rock	---	---	---	---	220
Culverts	1-1/2"-0"	Bedding/Backfill	---	---	---	---	70

ROAD SEGMENT:		2-6-11.1	STATION: 0+00 to 42+80				
Application	Rock Size and Type	Location	Compacted Depth	Volume per Station/Item (CY)	Approx. Total (CY)	Curve Widening (CY)	Summary Totals
Road Rock	1-1/2"-0"	Cap Rock: 0+00 - 42+80	4"	19	813	117	930
Road Rock	4"-0"	Base Rock: 0+00 - 42+80	8"	40	1,712	298	2,010
Road Rock	1-1/2"-0"	Spot Rock	---	---	---	---	100
Road Rock	4"-0"	Base Rock	---	---	---	---	190
Culverts	1-1/2"-0"	Bedding/Backfill	---	---	---	---	290
Drain Rock	1-1/2"-3/4"	Sta. 31+78	---	---	---	---	150
Fill Armor/Stabilization Wall Inlet	RipRap: Class 5	Sta. 9+51 - 10+25	---	---	---	---	60
Fill Armor/Stabilization Wall Outlet	RipRap: Class 5	Sta. 9+51 - 10+25, 31+78	---	---	---	---	240
Fill Armor Inlet	RipRap: Class 5	Sta. 17+51, 18+69, 34+33	---	---	---	---	50
Fill Armor/Dissipater Outlet	RipRap: Class 5	Sta. 17+51, 18+69, 34+34	---	---	---	---	135

**ROCK VOLUMES TOTALS**

ROAD SEGMENT: 2-6-11.2			STATION: 0+00 to 4+49				
Application	Rock Size and Type	Location	Compacted Depth	Volume per Station/Item (CY)	Approx. Total (CY)	Curve Widening (CY)	Summary Totals
Road Rock	1-1/2"-0"	Cap Rock: 0+00 - 4+49	4"	19	85	10	95
Road Rock	4"-0"	Base Rock: 0+00 - 4+49	8"	40	180	25	205
Road Rock	1-1/2"-0"	Spot Rock	---	---	---	---	50
Road Rock	4"-0"	Base Rock	---	---	---	---	90
Culverts	1-1/2"-0"	Bedding/Backfill	---	---	---	---	20

ROAD SEGMENT: 2-6-11.3			STATION: 0+00 to 2+83				
Application	Rock Size and Type	Location	Compacted Depth	Volume per Station/Item (CY)	Approx. Total (CY)	Curve Widening (CY)	Summary Totals
Road Rock	1-1/2"-0"	Cap Rock: 0+00 - 2+83	4"	19	54	7	61
Road Rock	4"-0"	Base Rock: 0+00 - 2+83	8"	40	113	19	132
Road Rock	1-1/2"-0"	Spot Rock	---	---	---	---	50
Road Rock	4"-0"	Base Rock	---	---	---	---	90

ROAD SEGMENT: 2-6-12.1			MILEAGE: 0.000 to 0.710				
Application	Rock Size and Type	Location/Number	Compacted Depth	Volume per Station/Item (CY)	Approx. Total (CY)	Curve Widening (CY)	Summary Totals
Road Rock	1-1/2"-0"	Spot Rock	---	---	---	---	350
Road Rock	4"-0"	Base Rock	---	---	---	---	135
Culverts	1-1/2"-0"	Spot Rock	---	---	---	---	50
Culverts	4"-0"	Base Rock	---	---	---	---	65
Culverts	1-1/2"-0"	Bedding/Backfill	---	---	---	---	65

ROAD SEGMENT: 2-6-14.0			STATION: 0+00 - 22+75				
Application	Rock Size and Type	Location/Number	Compacted Depth	Volume per Station/Item (CY)	Approx. Total (CY)	Curve Widening (CY)	Summary Totals
Road Rock	1-1/2"-0"	Spot Rock	---	---	---	---	280
Road Rock	4"-0"	Base Rock	---	---	---	---	125
Culverts	1-1/2"-0"	Spot Rock	---	---	---	---	30
Culverts	4"-0"	Base Rock	---	---	---	---	35
Culverts	1-1/2"-0"	Bedding/Backfill	---	---	---	---	35
Fill Armor Inlet	RipRap: Class 5	Sta. 12+45	---	---	---	---	5

**ROCK VOLUMES TOTALS**

ROAD SEGMENT: 2-6-14.1			STATION: 0+00 to 2+06				
Application	Rock Size and Type	Location	Compacted Depth	Volume per Station/Item (CY)	Approx. Total (CY)	Curve Widening (CY)	Summary Totals
Road Rock	1-1/2"-0"	Cap Rock: 0+00 - 2+06	4"	19	39	6	45
Road Rock	4"-0"	Base Rock: 0+00 - 2+06	8"	40	82	15	97
Road Rock	1-1/2"-0"	Spot Rock	---	---	---	---	30
Road Rock	4"-0"	Base Rock	---	---	---	---	20

ROAD SEGMENT: 2-6-14.2			STATION: 0+00 to 21+67				
Application	Rock Size and Type	Location	Compacted Depth	Volume per Station/Item (CY)	Approx. Total (CY)	Curve Widening (CY)	Summary Totals
Road Rock	1-1/2"-0"	Cap Rock: 0+00 - 21+67	4"	19	412	46	458
Road Rock	4"-0"	Base Rock: 0+00 - 17+80	6"	30	534	76	610
Road Rock	4"-0"	Base Rock: 17+80 - 21+67	8"	40	155	22	177
Road Rock	1-1/2"-0"	Spot Rock	---	---	---	---	80
Road Rock	4"-0"	Base Rock	---	---	---	---	150
Culverts	1-1/2"-0"	Bedding/Backfill	---	---	---	---	20
Lined Ditch	Pitrun	Sta. 3+42 - 5+22	---	---	---	---	30

ROAD SEGMENT: 2-6-14.3			STATION: 0+00 to 12+16				
Application	Rock Size and Type	Location	Compacted Depth	Volume per Station/Item (CY)	Approx. Total (CY)	Curve Widening (CY)	Summary Totals
Road Rock	1-1/2"-0"	Cap Rock: 0+00 - 12+16	4"	19	231	31	262
Road Rock	4"-0"	Base Rock: 0+00 - 12+16	8"	40	486	80	566
Road Rock	1-1/2"-0"	Spot Rock	---	---	---	---	60
Road Rock	4"-0"	Base Rock	---	---	---	---	110
Culverts	1-1/2"-0"	Bedding/Backfill	---	---	---	---	85
Fill Slope Armor	RipRap: Class 5	Sta. 1+50 - 2+63	---	---	---	---	170
Fill Armor Outlet	RipRap: Class 5	Sta. 11+51	---	---	---	---	10

**ROCK VOLUMES TOTALS**

ROAD SEGMENT:		2-6-14.4	STATION: 0+00 to 10+64				
Application	Rock Size and Type	Location	Compacted Depth	Volume per Station/Item (CY)	Approx. Total (CY)	Curve Widening (CY)	Summary Totals
Road Rock	1-1/2"-0"	Cap Rock: 0+00 - 10+64	4"	19	202	21	223
Road Rock	4"-0"	Base Rock: 0+00 - 10+64	6"	30	319	42	361
Road Rock	1-1/2"-0"	Spot Rock	---	---	---	---	30
Road Rock	4"-0"	Base Rock	---	---	---	---	60

ROAD SEGMENT:		2-6-14.5	STATION: 0+00 to 1+50				
Application	Rock Size and Type	Location	Compacted Depth	Volume per Station/Item (CY)	Approx. Total (CY)	Curve Widening (CY)	Summary Totals
Road Rock	1-1/2"-0"	Cap Rock: 0+00 - 1+50	4"	19	29	2	31
Road Rock	4"-0"	Base Rock: 0+00 - 1+50	8"	40	60	8	68
Road Rock	1-1/2"-0"	Spot Rock	---	---	---	---	40
Road Rock	4"-0"	Base Rock	---	---	---	---	70

ROAD SEGMENT:		2-6-14.6	STATION: 0+00 to 3+62				
Application	Rock Size and Type	Location	Compacted Depth	Volume per Station/Item (CY)	Approx. Total (CY)	Curve Widening (CY)	Summary Totals
Road Rock	1-1/2"-0"	Cap Rock: 0+00 - 3+62	4"	19	69	9	78
Road Rock	4"-0"	Base Rock: 0+00 - 3+62	8"	40	145	24	169
Road Rock	1-1/2"-0"	Spot Rock	---	---	---	---	40
Road Rock	4"-0"	Base Rock	---	---	---	---	80
Culverts	1-1/2"-0"	Bedding/Backfill	---	---	---	---	20

ROAD SEGMENT:		2-6-15.4	STATION: 0+00 to 23+51				
Application	Rock Size and Type	Location	Compacted Depth	Volume per Station/Item (CY)	Approx. Total (CY)	Curve Widening (CY)	Summary Totals
Road Rock	1-1/2"-0"	Cap Rock: 0+00 - 23+51	4"	19	447	106	553
Road Rock	4"-0"	Base Rock: 0+00 - 23+51	8"	40	940	253	1,193
Road Rock	1-1/2"-0"	Spot Rock	---	---	---	---	60
Road Rock	4"-0"	Base Rock	---	---	---	---	110
Culverts	1-1/2"-0"	Bedding/Backfill	---	---	---	---	30
Fill Armor/Stabilization Wall Fill Slope	RipRap: Class 5	Sta. 0+00 - 1+32	---	---	---	---	330



United States Department of Interior  
 BUREAU OF LAND MANAGEMENT  
 NORTHWEST OREGON DISTRICT - OREGON  
 EXHIBIT C - APPENDIX C-1

Fairchild Timber Sale  
 Contract NO. ORN04-TS-2020-0402

Road: 2-6-15.4

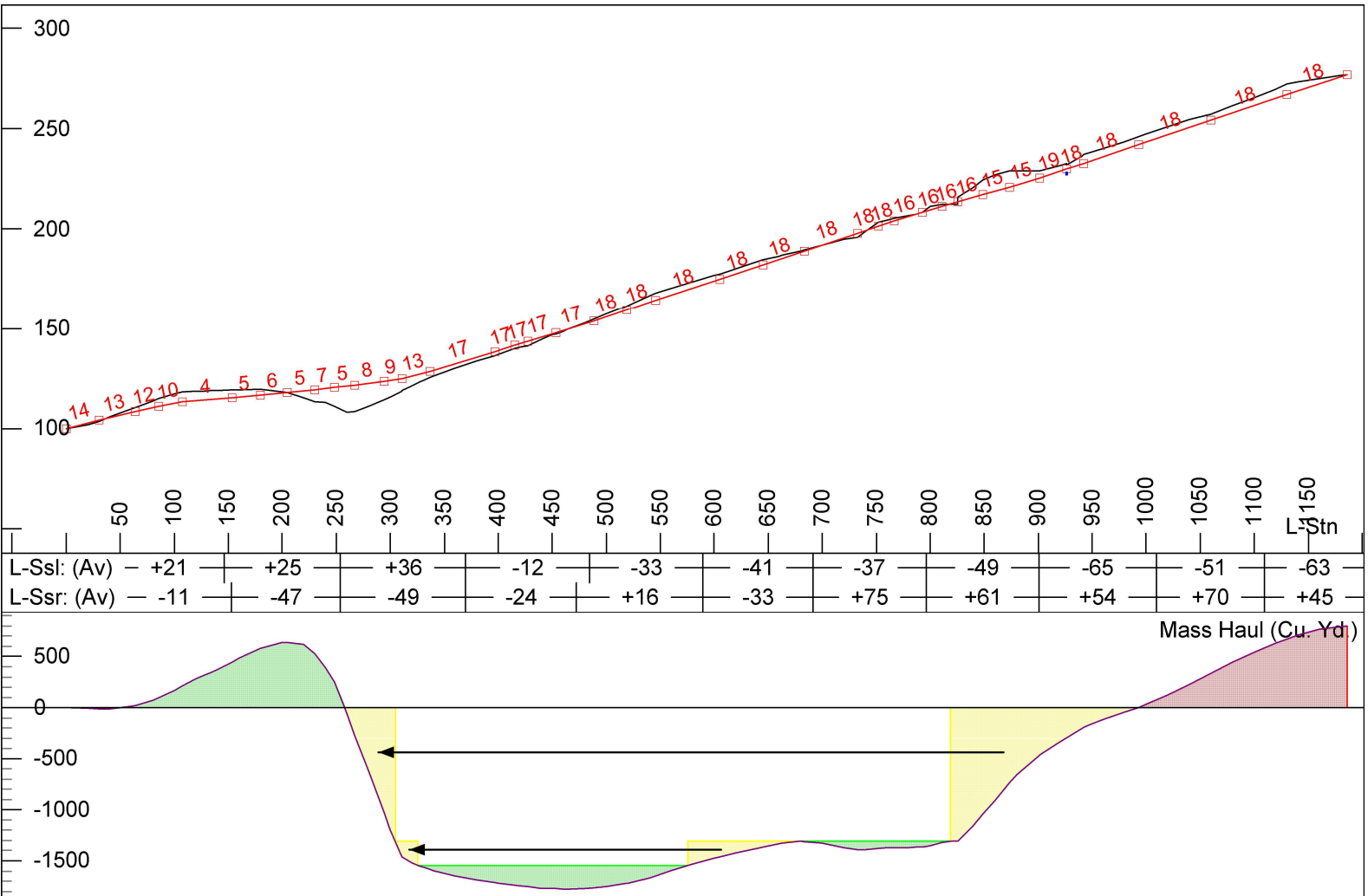
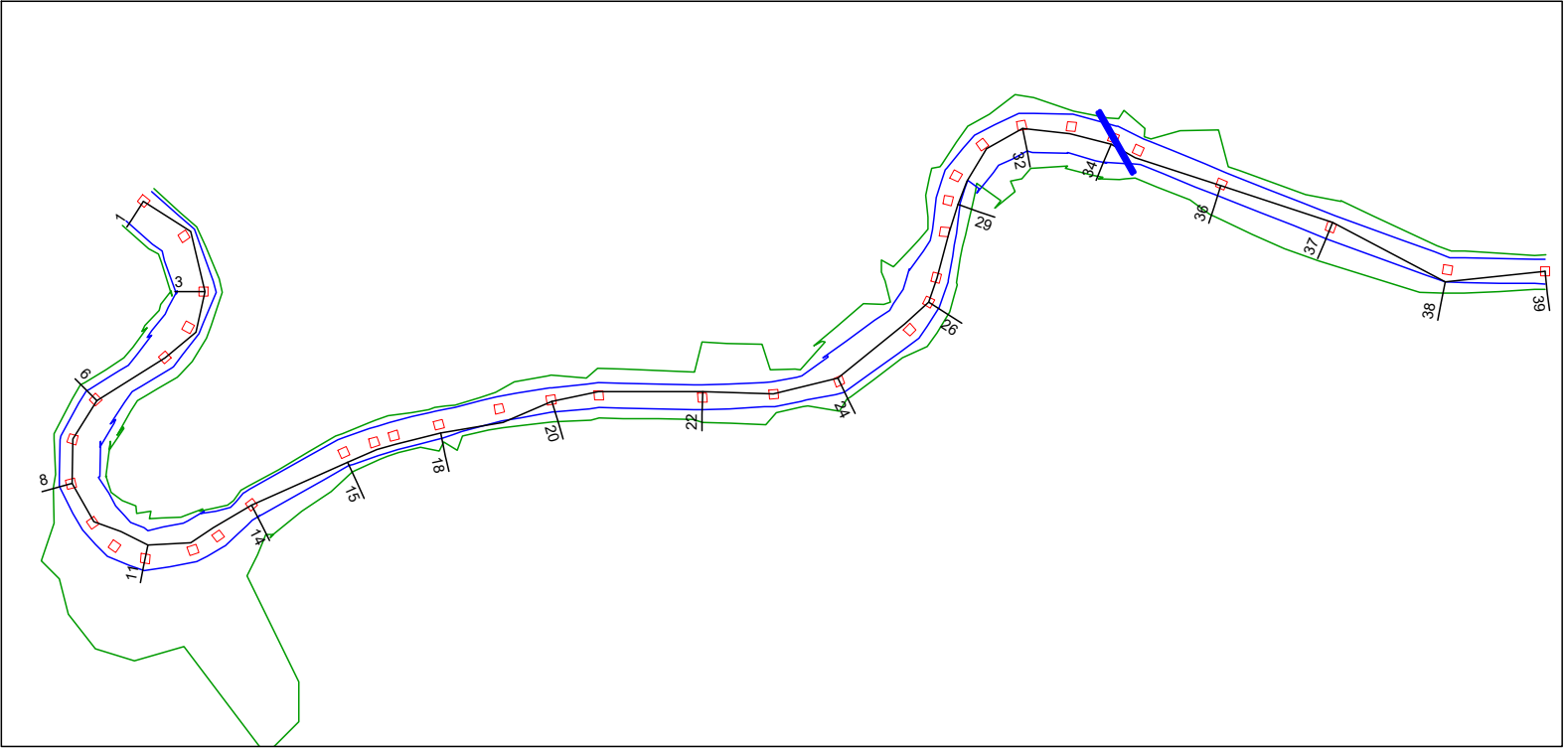

United States Department of Interior  
 BUREAU OF LAND MANAGEMENT  
 NORTHWEST OREGON DISTRICT - OREGON  
 EXHIBIT C - APPENDIX C-1

Fairchild Timber Sale  
 Contract NO. ORN04-TS-2020-0402

Road: 2-6-15.4

Index	Azimuth deg.	H.Offset ft.	SD ft.	L-Stn ft.	Cut Dp. ft.	Grade %
1		0.0		0.0	0.0	14.0
2	329	4.5	30.7	30.4	-0.8	12.8
3	358	1.0	33.6	63.8	2.0	12.3
4	41	5.2	22.2	85.8	3.8	10.1
5	55	0.3	21.7	107.4	5.0	4.2
6	77	1.0	46.2	153.7	3.9	4.8
7	48	0.0	26.0	179.6	3.0	5.9
8	20	0.5	25.3	204.9	-0.1	5.0
9	349	1.0	25.4	230.2	-5.9	7.1
10	334	9.0	18.2	248.3	-9.4	4.6
11	310	8.0	18.7	267.0	-13.0	7.6
12	278	4.5	27.6	294.6	-9.1	8.7
13	259	5.5	16.4	294.6	-6.2	12.9
14	245	-0.5	26.3	310.9	-2.7	16.7
15	259	-6.0	60.8	337.0	-1.9	17.0
16	269	-4.5	18.6	397.0	-1.4	16.9
17	270	-5.0	11.9	415.3	-2.1	16.8
18	274	-5.0	26.7	427.1	-0.6	16.7
19	273	-8.0	35.9	453.5	0.9	18.2
20	278	-1.0	30.4	488.9	2.1	18.4
21	282	2.0	27.6	518.8	3.7	17.8
22	289	3.3	59.9	545.9	2.5	18.0
23	285	0.0	41.2	604.9	2.5	17.8
24	277	1.8	38.4	645.4	0.8	18.4
25	252	4.5	50.5	683.3	-2.1	18.3
26	232	-0.2	19.4	733.0	2.0	18.0
27	216	-0.2	14.7	752.0	1.2	15.8
28	208	-2.5	26.7	766.4	0.2	16.4
29	205	-6.0	18.1	792.8	1.0	15.9
30	216	-7.0	14.9	810.7	2.4	15.7
31	238	-3.5	23.5	825.4	7.3	15.3
32	262	-1.8	25.1	848.6	7.9	15.4
33	289	-4.0	28.7	873.4	3.6	18.6
34	303	-4.0	25.2	901.7	2.2	18.0
35	314	-4.8	16.0	926.4	4.4	18.5
36	310	-1.0	51.8	942.2	4.0	17.9
37	309	3.0	67.9	993.1	3.0	18.3
38	308	-7.0	71.8	1059.9	5.4	18.0
39	289	0.0	56.4	1130.5	0.0	
				1186.1		

United States Department of Interior  
 BUREAU OF LAND MANAGEMENT  
 NORTHWEST OREGON DISTRICT - OREGON  
 EXHIBIT C - APPENDIX C-1

Fairchild Timber Sale  
 Contract NO. ORN04-TS-2020-0402

Road: 2-6-14.6

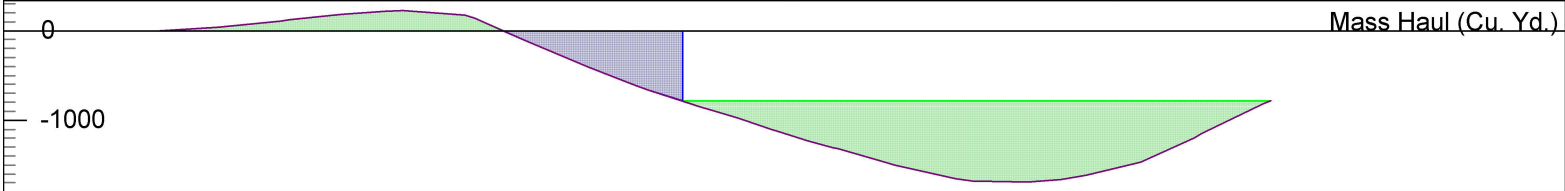
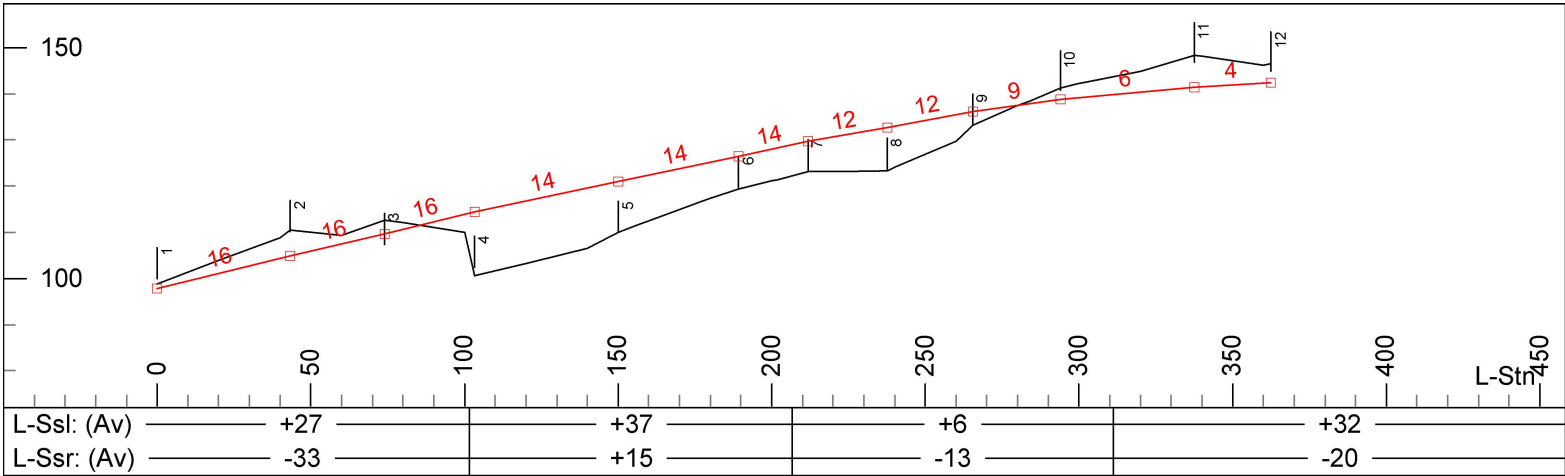
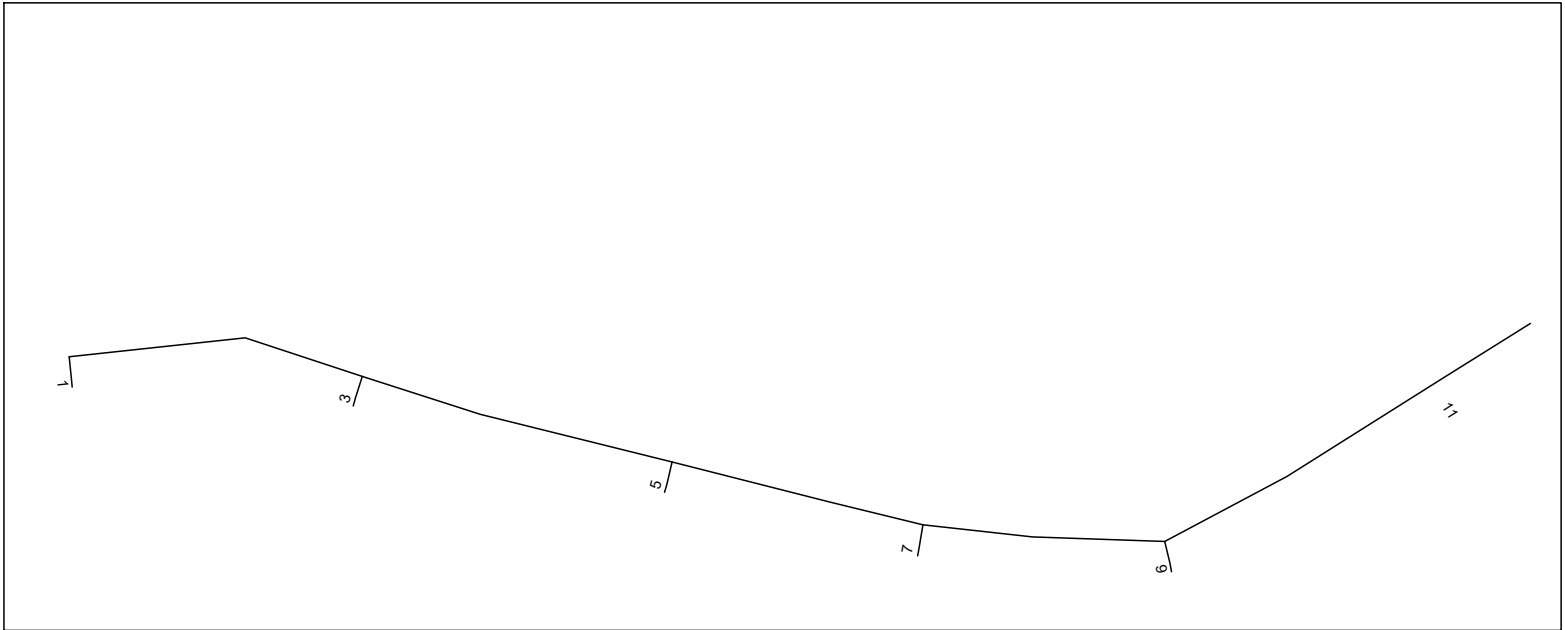

Index	Azimuth deg.	H.Offset ft.	SD ft.	L-Stn ft.	Cut Dp. ft.	Grade %
1		-8.0		0.0	0.9	
2	305	-4.0	43.9	43.3	5.6	15.9
3	315	-8.5	31.0	74.0	3.0	15.8
4	318	-11.5	29.6	103.2	-13.8	16.2
5	321	-11.0	47.4	150.1	-11.0	14.0
6	327	-6.0	39.5	189.2	-7.1	13.9
7	320	-6.0	22.7	211.7	-6.6	14.1
8	305	-9.0	26.0	237.6	-9.4	11.7
9	295	-16.0	28.0	265.4	-3.0	12.4
10	283	-13.0	28.7	293.9	2.5	9.1
11	281	-8.0	43.6	337.4	6.9	6.0
12	279	-6.0	25.0	362.4	4.1	4.0

United States Department of Interior  
 BUREAU OF LAND MANAGEMENT  
 NORTHWEST OREGON DISTRICT - OREGON  
 EXHIBIT C - APPENDIX C-1

Fairchild Timber Sale  
 Contract NO. ORN04-TS-2020-0402

Road: 2-6-14.2

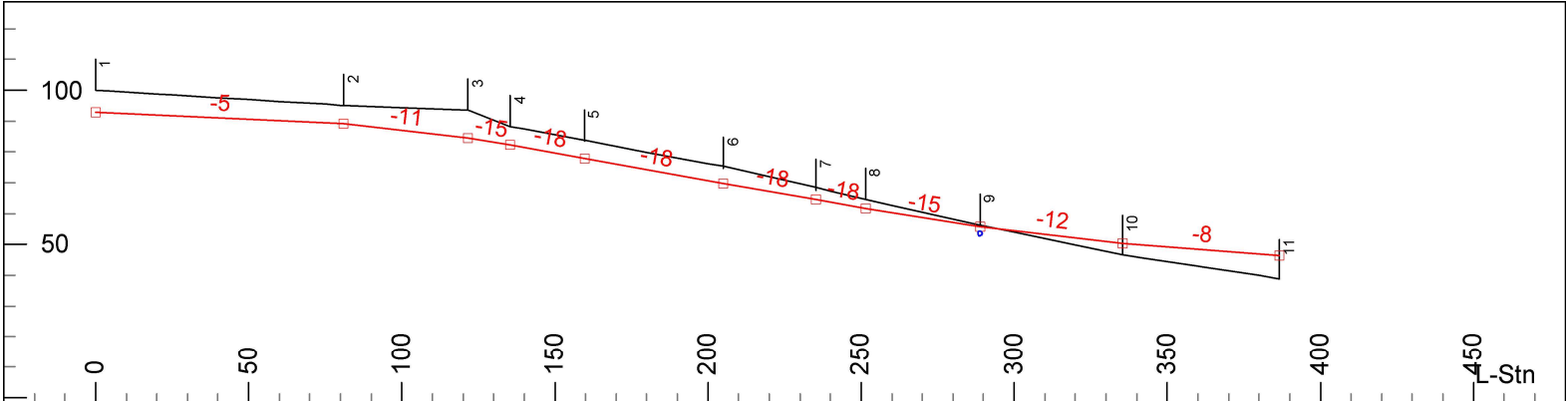
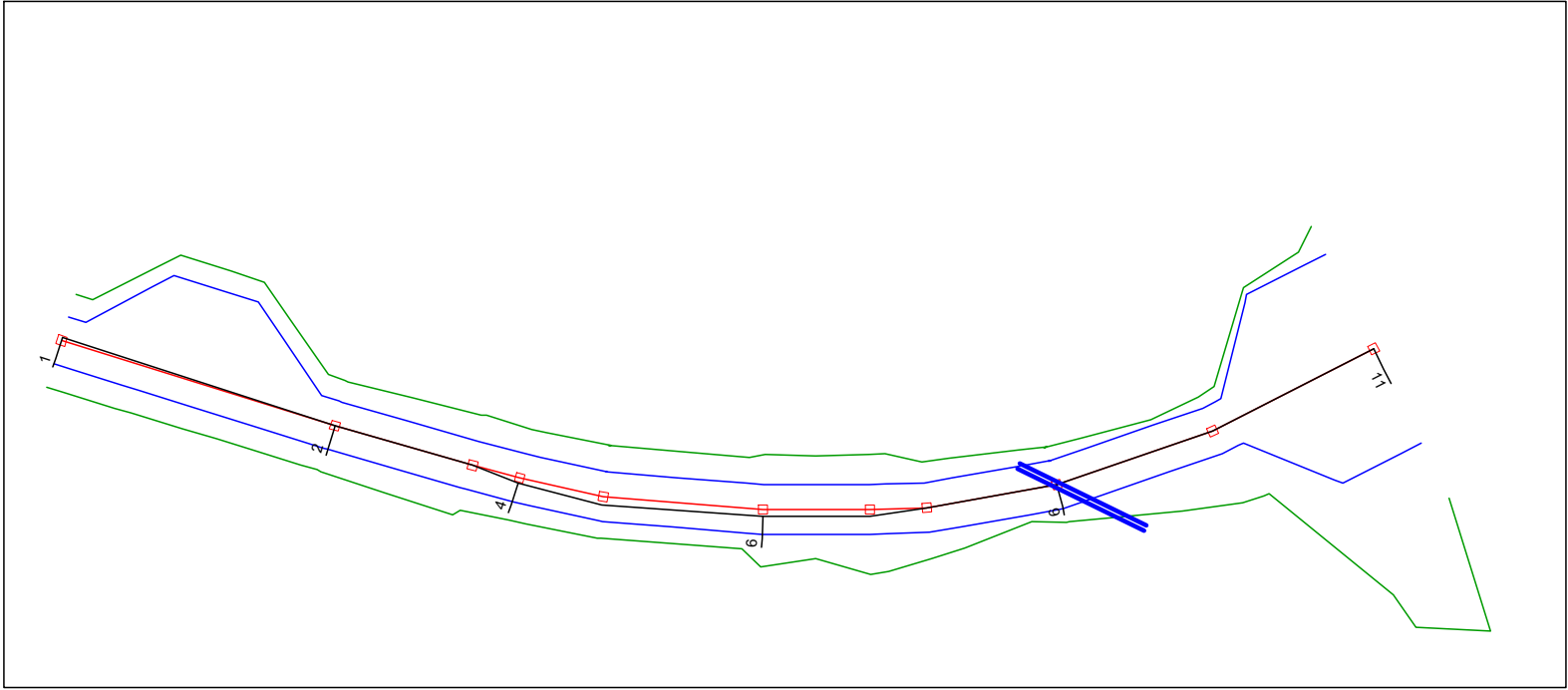

Index	L-Ssl: (Av)	L-Ssr: (Av)
1	-5	+2
2	+37	-40
3	+18	-30
4	+13	-29

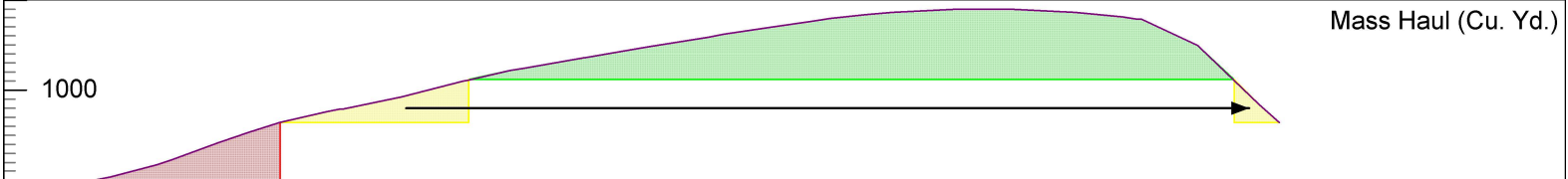

Index	Azimuth deg.	H.Offset ft.	SD ft.	L-Stn ft.	Cut Dp. ft.	Grade %
1	86	1.0	81.2	0.0	7.0	-4.8
2	85	0.0	40.8	81.1	6.0	-11.4
3	84	0.0	14.0	121.6	9.0	-15.4
4	82	-1.5	24.7	135.4	5.9	-18.2
5	82	-2.5	46.1	159.7	5.9	-18.0
6	74	-2.0	30.7	205.1	5.7	-17.6
7	69	-2.0	16.4	235.3	3.9	-18.0
8	67	0.0	37.8	251.4	3.0	-15.3
9	59	0.0	47.0	288.8	0.5	-11.9
10	50	0.0	51.3	335.5	-3.8	-7.7
11	42	0.0		386.6	-7.5	-7.5

## ROAD MAINTENANCE SPECIFICATIONS

General road maintenance specifications are designated by numeric symbols according to the type of work performed as follows:

SECTION	DESCRIPTION
3000	General
3100	Operational Maintenance
3200	Seasonal Maintenance
3300	Final Maintenance
3400	Other Maintenance
3500	Decommissioning

**GENERAL - 3000**

- 3001 The Purchaser shall be required to maintain all roads as shown on the Exhibit E maps of this contract in accordance with Sections 3000, 3100, 3200, 3300, 3400, and 3500 of this exhibit.
- 3002 The Purchaser shall maintain the cross section of existing dirt or graveled roads to the existing geometric standards. Any roads required to be constructed, improved, or renovated under terms of this contract shall be maintained to the geometric standards required in Exhibit C of this contract.
- 3003 The minimum required maintenance on any Purchaser maintained roads shall include the provisions specified in Subsections 3101, 3104, and 3105.
- 3004 The Purchaser shall be responsible for providing timely maintenance and cleanup on any roads with logging units substantially completed prior to moving operations to other roads. The maximum length of non-maintained or non-cleanup of the road prism shall not exceed the sum of one (1) mile at any time. Release of maintenance requirements may be granted, upon written request, when the conditions specified in Sections 3300 and 3400 are met satisfactorily.

**OPERATIONAL MAINTENANCE - 3100**

- 3101 The Purchaser shall blade and shape the road surface and shoulders with a motor grader. Banks shall not be undercut. Back blading with tractors or similar equipment will be allowed only around landings and other areas when approved by the Authorized Officer.
- 3102 The Purchaser shall furnish and place 1,390 cu.yds. of aggregate conforming to the requirements in Sections 1200 of Exhibit C of this contract on the roadway at locations and in the amounts designated by the Authorized Officer.

**640** cu.yds. - To be placed on BLM controlled roads as directed by Authorized Officer (maintenance rock: Sections 42r).

**255** cu yds – To be placed on non-BLM controlled roads as directed by the Authorized Officer (maintenance rock: Section 42v)

This aggregate shall be used to repair surface failures and areas of depleted surface depth excluding damages covered by Section 12 of this contract. The aggregate shall be furnished, hauled, placed, spread, and compacted by use of dump trucks, water trucks, and motor grader or similar equipment.

- 3104 The purchaser shall perform other road cleanup including removal of debris, fallen timber, bank slough, and slides which can practicably be accomplished by a motor grader, rubber tired front end bucket loader, rubber tired backhoe or comparable equipment, and by the use of hand tools.
- 3104a Removal of bank slough and slide material includes placement of material at the nearest designated, suitable disposal site where material cannot erode into streams, lakes, or reservoirs or cause undue damage to road fill slopes which have been planted or mulched to control soil erosion as directed by the Authorized Officer.
- 3104b The Purchaser shall be responsible for removal of all slides or slough, up to fifteen station yards in quantity, at any one site. This work includes unlimited multiple sites on all roads required to be maintained by the purchaser.
- Prior to removal of any slough or slide material exceeding fifteen station yards at any one site, the Purchaser and the Authorized Officer or their Authorized Representatives shall agree in writing, in the field, to the quantity of material, method of disposal, and the disposal site. Work may commence immediately after agreement.
- Upon completion of agreed upon work, a reduction in timber sale purchase price will be made to offset the cost of the work, based on current BLM Road Cost Guide. Adjustments in purchase price for completed work shall be made as necessary and no less than once per year when actual work is ongoing.
- 3105 The Purchaser shall be responsible for maintaining normal flow in drainage structures. This includes cleaning out drainage ditches, catch basins, clearing pipe inverts of sediment and other debris lodged in the barrel of the pipe, and maintaining water dips and waterbars using equipment specified in Subsection 3104 and other culvert cleaning and flushing equipment.
- 3108 The Purchaser shall avoid fouling gravel or bituminous surfaces through covering with earth and debris from side ditches, slides or other sources. The Purchaser shall also avoid blading surfacing material off the running surface of the roadway. (Skidding of logs on the roadway in or outside designated logging units is not authorized without prior written approval by the Authorized Officer. Repair required caused by such skidding activity is not considered maintenance and shall be repaired at the Purchaser's expense.)

### **SEASONAL MAINTENANCE - 3200**

- 3201 The Purchaser shall perform preventative maintenance at the end of Purchaser's hauling each season and during non-hauling periods which occur between other operations on the contract area. This includes requirements specified in Section 3100.

- 3202 The purchaser shall perform and complete maintenance specified in Sections 3000, 3100, and 3200 on all roads maintained by him, during times when there is a low potential to deliver sediment to streams, as determined by Authorized Officer, and as specified in Subsection 3203, after initial commencement of construction or logging operations. Thereafter, all roads shall have continuous preventive maintenance and road cleanup. This includes all roads used and not used during the preceding operating seasons.
- 3203 The Purchaser shall complete road cleanup and maintenance, as specified in Section 3100, at the completion of logging operations on any roads located in an area separate from the area where logging activities will resume.
- 3204 The Purchaser shall be responsible for performing post storm inspections and maintenance during the winter season to minimize erosion and potential road or watershed damage.

#### **FINAL MAINTENANCE - 3300**

- 3301 The Purchaser shall complete final maintenance and/or damage repairs on all roads used under terms of their contract within thirty (30) calendar days following the completion of hauling and in accordance with Sec. 16(b) of this contract. This work shall include any maintenance and/or damage repairs specified in Sections 3000, 3100, and 3200 necessary to meet the conditions specified in Subsection 3002 and shall be executed in accordance with Subsection 3302 of this section.

The Authorized Officer may grant acceptance of Purchaser's maintenance responsibility in part where certain individual roads or road segments are no longer of any use to the Purchaser's remaining removal operations, providing that all contract requirements as specified under Sec. 16(b), Special Provisions (Sections 3000, 3100, 3200 and 3300 of the maintenance specifications) have been completed and a relinquishment of cutting and removal rights on cutting units tributary to these roads is signed by the Purchaser. Request for partial acceptance must be submitted in writing by the Purchaser.

- 3302 The Purchaser shall perform final road maintenance only when weather or soil moisture conditions are suitable for normal maintenance equipment operations as determined by the Authorized Officer.

If final maintenance is delayed after the date required in Subsection 3301 of this contract by adverse soil moisture or unsuitable equipment operating conditions, the Purchaser will be notified by the Authorized Officer when soil moisture and equipment operating conditions are suitable. The Purchaser shall then be required to complete final maintenance within 30 days.



**OTHER MAINTENANCE - 3400**

- 3401 The Purchaser shall repair any damage to road surfaces that was specified under Subsection 3108. This repair includes restoring the roadway to the designed standard and replacement of surfacing with approved surface material. This repair is not limited to use of equipment specified in Subsection 3104.
- 3402 The Purchaser shall be permitted to remove ice and snow from roads authorized for use under this contract only when prior written approval has been secured from the Authorized Officer. The Purchaser shall submit a written request for permission to remove ice and snow in advance of the date operations are to begin.
- Upon receiving written authorization for ice or snow removal, the Purchaser will perform the work according to the conditions and equipment requirements set forth in the authorization.

**DECOMMISSIONING – 3500**

- 3501c Stabilization on the following roads shall consist of installing drivable waterbars/waterdips (as directed). This work is *not* required for road acceptance under Section 18 of this contract.

Road No or Site	From Sta/MP	To Sta/MP	Length
2-6-10.1	0+00	17+63	1,763 ft
2-6-10.2	0+00	1+62	162 ft
2-6-11.0	16+30	45+79	2,949 ft
2-6-11.1	0+00	42+80	4,280 ft
2-6-11.2	0+00	4+49	449 ft
2-6-11.3	0+00	2+83	283 ft
2-6-14.2	17+80	21+67	387 ft
2-6-14.3	0+00	12+16	1,216 ft
2-6-14.5	0+00	1+50	150 ft
2-6-14.6	0+00	3+62	362 ft
2-6-15.4	0+00	23+51	2,351 ft

- 3504 Decommissioning and Stabilization work shall be completed after all harvesting activities requiring that road segment have ceased, unless otherwise authorized in writing by the Authorized Officer. All decommissioning and stabilization work shall be performed during times when there is a low potential to deliver sediment to streams, as determined by the Authorized Officer (except in-stream work, which is in lines 2 North Yamhill River Watershed:

July 15	September 30

3513 Waterbars (drivable and non-drivable)/Waterdips shall be installed across full width of roadway at locations marked in the field by Authorized Officer and constructed to the dimensions of the waterbar detail on Page 44 of Exhibit C.

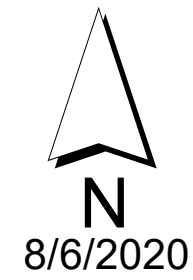





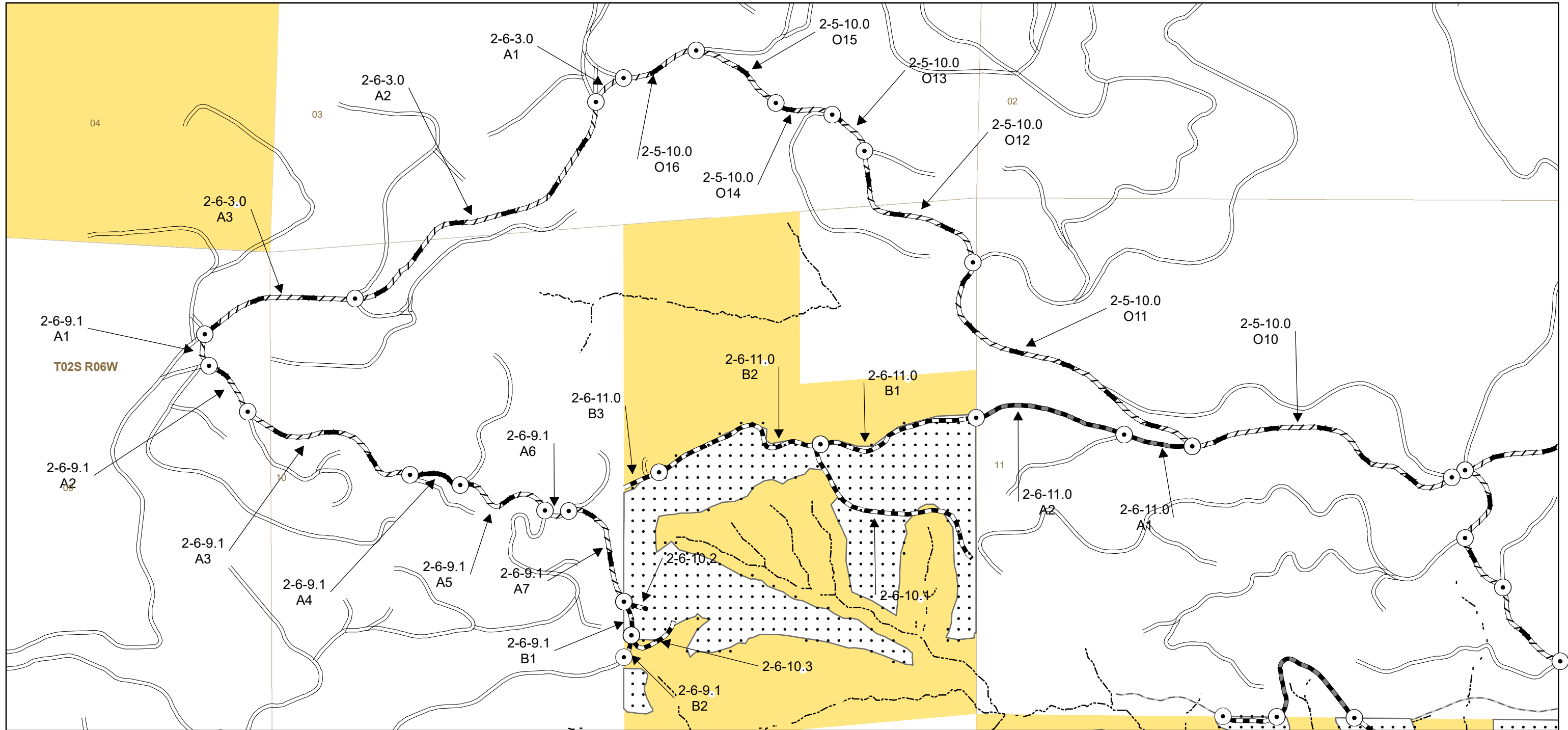

8/6/2020

# United States Department of Interior BUREAU OF LAND MANAGEMENT NORTHWEST OREGON DISTRICT - OREGON Road Plan Map

Fairchild Timber Sale  
Contract NO. ORN04-TS-2020.0402  
Exhibit E  
Page 1 of 5

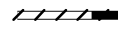
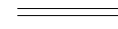
T. 02S. R. 6W. Sections 10, 11, 13, & 14 W.M. - NORTHWEST OREGON DISTRICT - OREGON



-  BLM controlled road - Purchaser Maintenance
-  Weyerhaeuser controlled road - Purchaser Maintenance
-  Weyerhaeuser controlled road - Weyerhaeuser Maintenance
-  Existing Roads
-  Segment Breaks
-  Streams
-  Fairchild Project Area
-  Bureau of Land Management

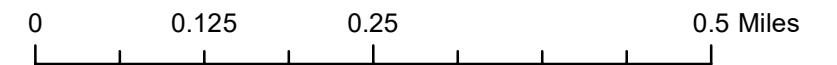

No warranty is made by the Bureau of Land Management as to the accuracy, reliability, or completeness of these data for individual or aggregate use with other data. Original data were compiled from various sources and may be updated without notification.  
Prepared By: Austin Bettis







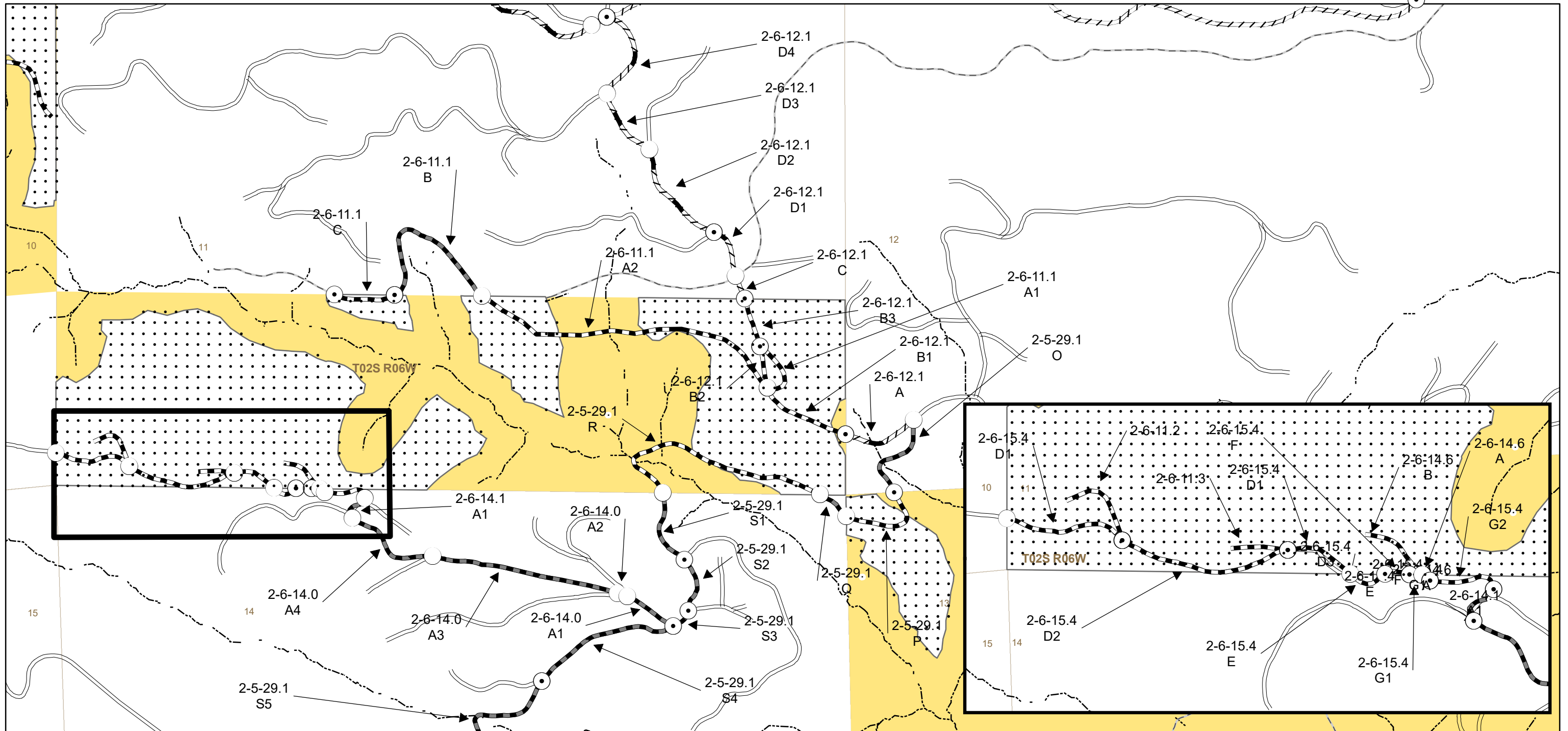

United States Department of Interior  
**BUREAU OF LAND MANAGEMENT**  
 NORTHWEST OREGON DISTRICT - OREGON  
**Road Plan Map**

Fairchild Timber Sale  
 Contract NO. ORN04-TS-2020.0402  
 Exhibit E  
 Page 2 of 5

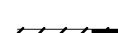
  
**N**  
 8/6/2020

**T. 02S. R. 6W. Sections 10, 11, 13, & 14 W.M. - NORTHWEST OREGON DISTRICT - OREGON**



-  BLM controlled road - Purchaser Maintenance
-  Weyerhaeuser controlled road - Purchaser Maintenance
-  Weyerhaeuser controlled road - Weyerhaeuser Maintenance
-  Existing Roads
-  Segment Breaks
-  Streams
-  Fairchild Project Area
-  Bureau of Land Management

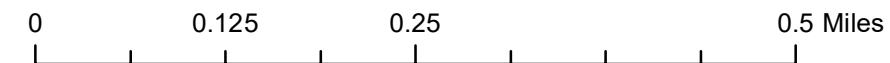

No warranty is made by the Bureau of Land Management as to the accuracy, reliability, or completeness of these data for individual or aggregate use with other data. Original data were compiled from various sources and may be updated without notification.  
 Prepared By: Austin Bettis

United States Department of Interior  
 BUREAU OF LAND MANAGEMENT  
 NORTHWEST OREGON DISTRICT - OREGON  
**Road Plan Map**

Fairchild Timber Sale  
 Contract NO. ORN04-TS-2020.0402  
 Exhibit E  
 Page 3 of 5

8/6/2020

T. 02S. R. 6W. Sections 10, 11, 13, & 14 W.M. - NORTHWEST OREGON DISTRICT - OREGON

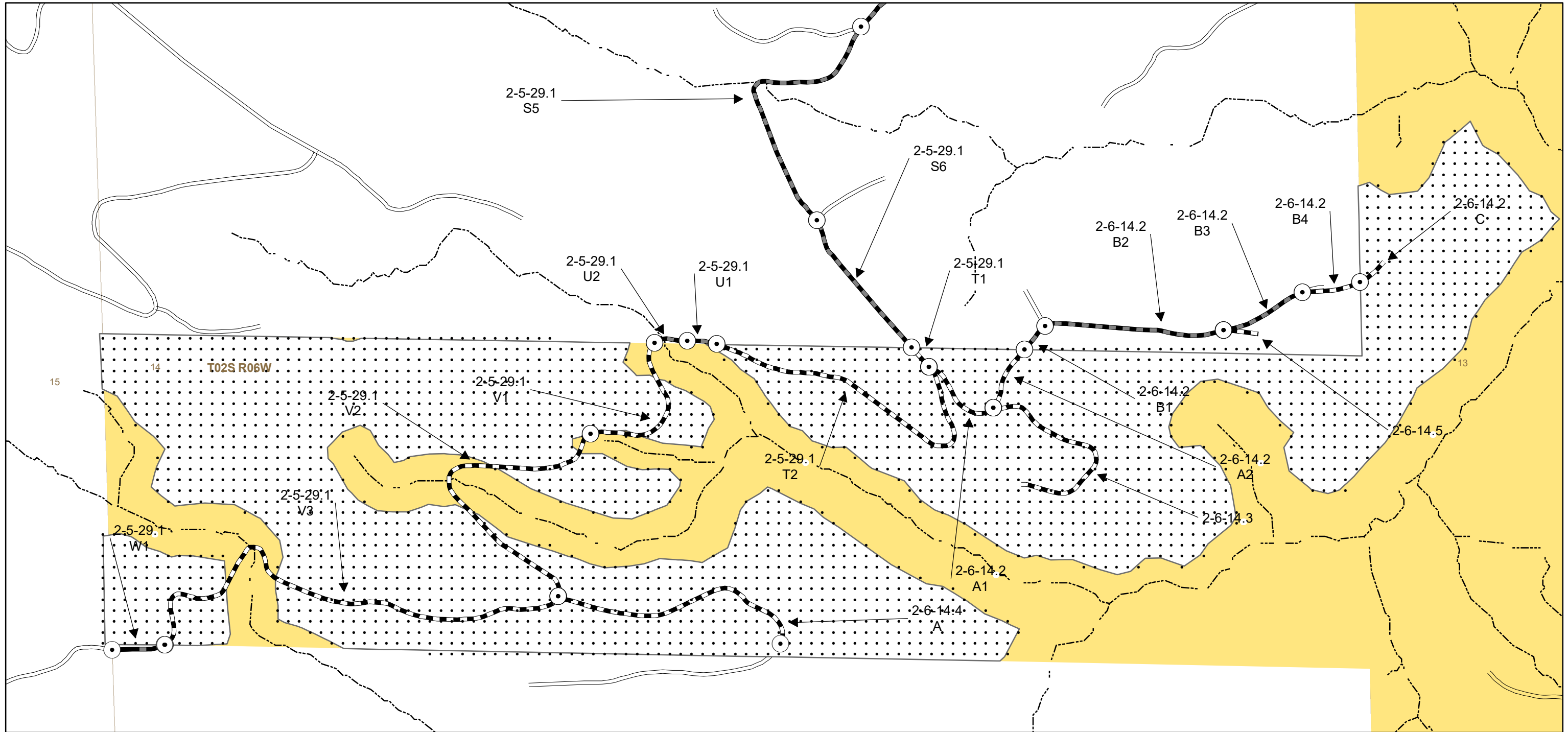

- BLM controlled road - Purchaser Maintenance
- Streams
- Weyerhaeuser controlled road - Purchaser Maintenance
- Fairchild Project Area
- Existing Roads
- Bureau of Land Management
- Segment Breaks

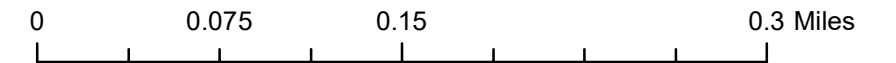





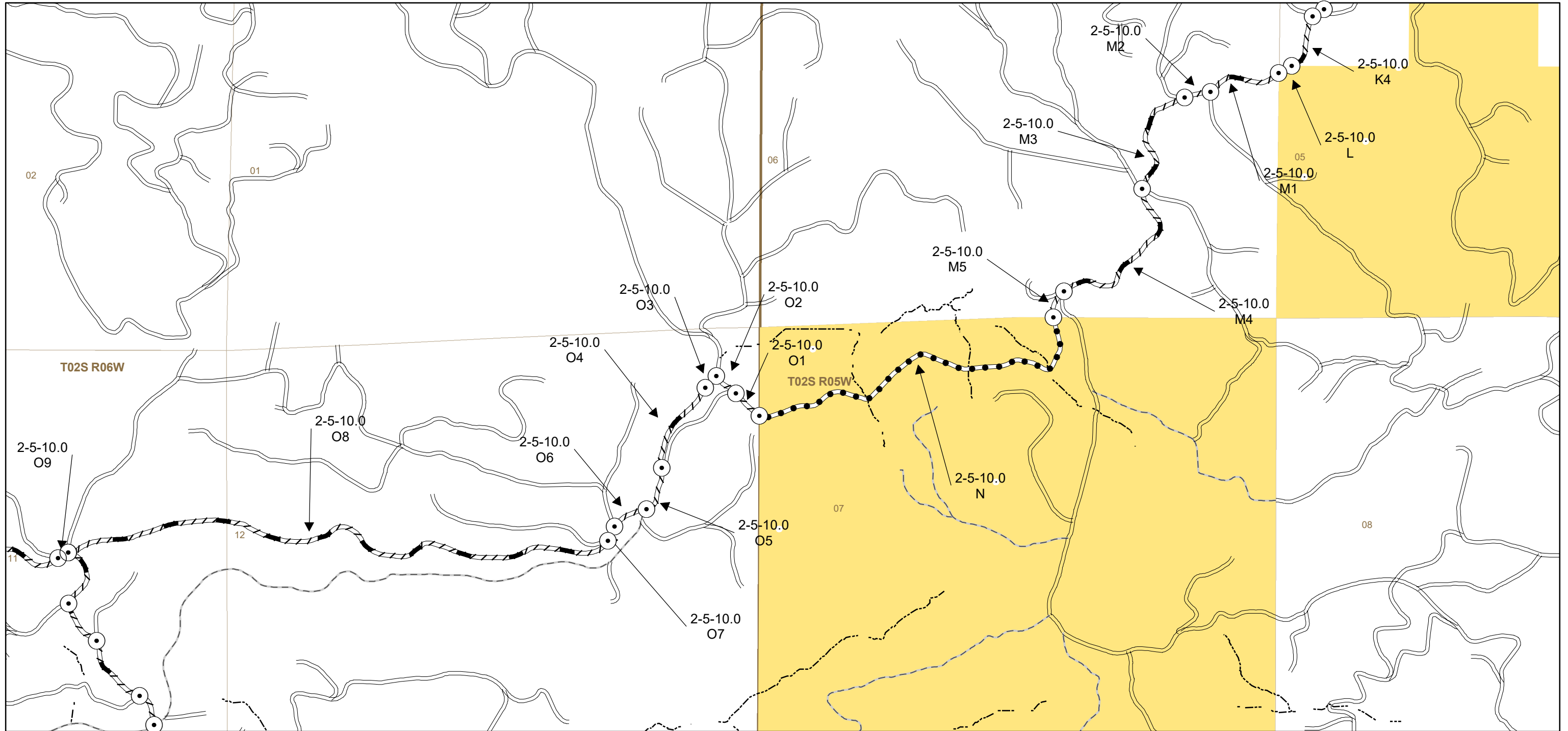

No warranty is made by the Bureau of Land Management as to the accuracy, reliability, or completeness of these data for individual or aggregate use with other data. Original data were compiled from various sources and may be updated without notification.  
 Prepared By: Austin Bettis

United States Department of Interior  
**BUREAU OF LAND MANAGEMENT**  
 NORTHWEST OREGON DISTRICT - OREGON  
**Road Plan Map**

  
 8/6/2020

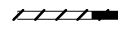
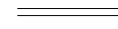
T. 02S. R. 6W. Sections 10, 11, 13, & 14 W.M. - NORTHWEST OREGON DISTRICT - OREGON



-  BLM controlled road - Purchaser Maintenance
-  BLM controlled road - Weyerhaeuser Maintenance
-  Weyerhaeuser controlled road - Weyerhaeuser Maintenance
-  Existing Roads
-  Segment Breaks
-  Streams
-  Fairchild Project Area
-  Bureau of Land Management

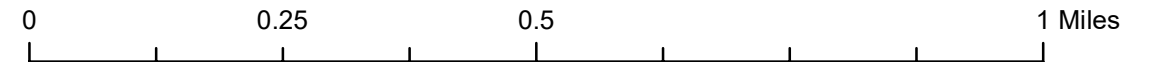

No warranty is made by the Bureau of Land Management as to the accuracy, reliability, or completeness of these data for individual or aggregate use with other data. Original data were compiled from various sources and may be updated without notification.  
 Prepared By: Austin Bettis





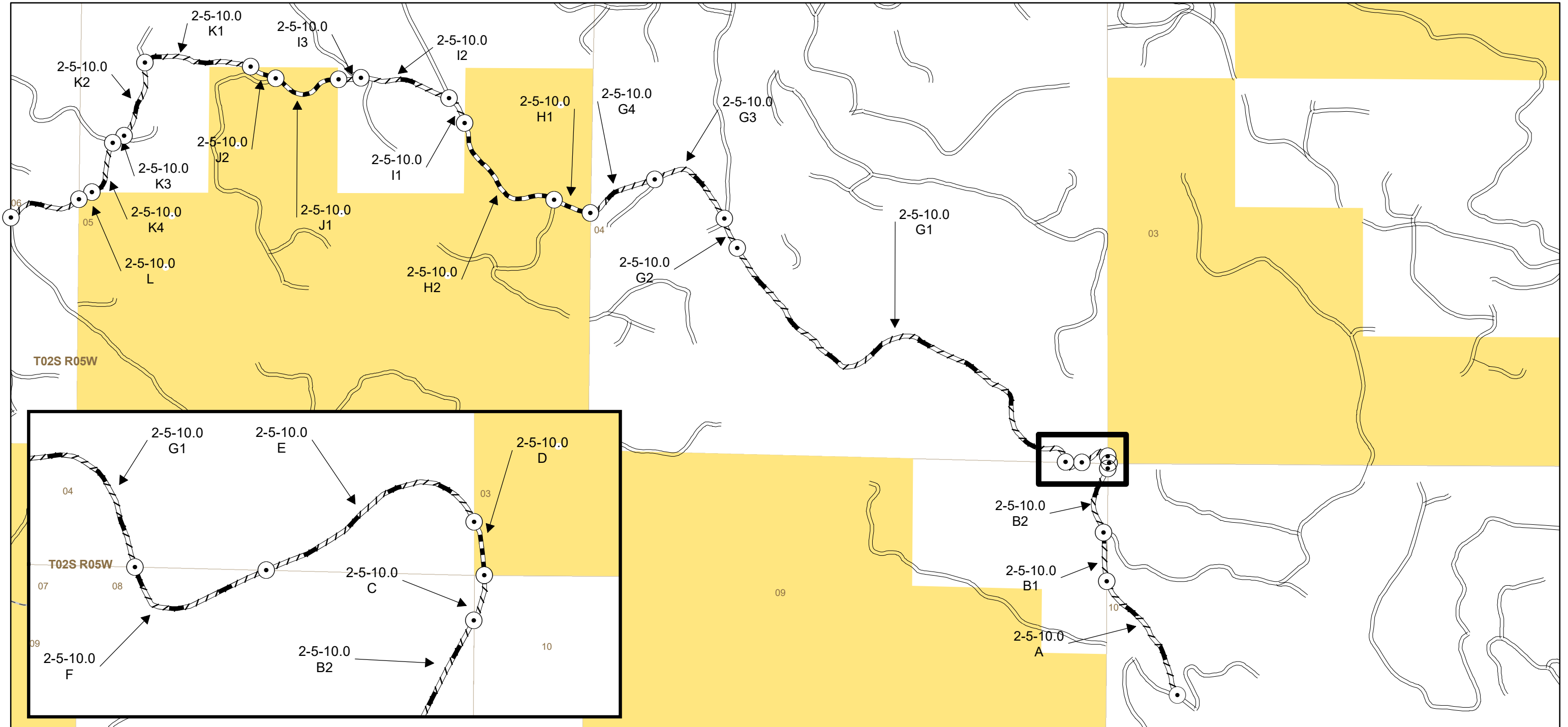

United States Department of Interior  
**BUREAU OF LAND MANAGEMENT**  
 NORTHWEST OREGON DISTRICT - OREGON  
**Road Plan Map**

Fairchild Timber Sale  
 Contract NO. ORN04-TS-2020.0402  
 Exhibit E  
 Page 5 of 5

  
**N**  
 8/6/2020

**T. 02S. R. 6W. Sections 10, 11, 13, & 14 W.M. - NORTHWEST OREGON DISTRICT - OREGON**



-  BLM controlled road - Purchaser Maintenance
-  Weyerhaeuser controlled road - Weyerhaeuser Maintenance
-  Existing Roads
-  Segment Breaks
-  Streams
-  Fairchild Project Area
-  Bureau of Land Management

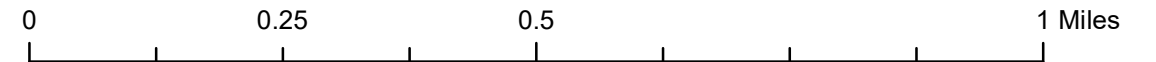

No warranty is made by the Bureau of Land Management as to the accuracy, reliability, or completeness of these data for individual or aggregate use with other data. Original data were compiled from various sources and may be updated without notification.  
 Prepared By: Austin Bettis

COARSE WOODY DEBRIS (CWD) CREATION

The Purchaser shall select and treat a total of five hundred eighty-two (582) reserve trees in the CWD Creation Units shown on Exhibit F maps (pages 10 and 11) to create Coarse Woody Debris (CWD) by saw-topping, high-girdling, basal-girdling or felling. Treated trees will be marked with numbered aluminum tags and flagging. The Purchaser shall record the tree tag number, treatment type, tree data, and UTM coordinates for all treated trees on the Wildlife Tree Data Recording Forms (Illustration #4).

Treatment of trees to create CWD within any given unit shall not start until all yarding operations within that unit are complete. The Purchaser must provide a proposed schedule of work to the Authorized Officer at least one week prior to commencing the CWD creation activities.

**CWD Creation per CWD Unit**

CWD Unit Number <sup>1</sup> (section)	Acres	Total Trees	Saw-Top	High Girdle	Basal Girdle	Fell	Tree Size to be Selected <sup>2</sup> (inches at DBH)
1 (10)	32	32	13	13	6	0	20-28
2 (10)	26	26	13	13	0	0	20-28
3RR (10)	25	70	20	20	20	10	Snags: 50% 10-20; Fell: 50% 12-20; ALL: 50% 20-32
4 (11)	52	52	52	0	0	0	23-30
6 (11)	8	8	8	0	0	0	20-28
7 (11)	31	31	13	12	6	0	20-28
8 (14)	3	3	3	0	0	0	20-28
9RR (14)	13	45	10	10	9	16	Snags: 50% 10-20; Fell: 50% 12-20; ALL: 50% 20-32
10 (14)	52	52	22	20	10	0	20-28
11RR (14 & 13)	74	210	45	45	45	75	Snags: 50% 10-20; Fell: 50% 12-20; ALL: 50% 20-32
12 (14)	30	30	16	14	0	0	20-28
13 (13)	14	14	14	0	0	0	23-30
14 (13)	9	9	5	4	0	0	16-26
<b>Totals</b>	<b>369</b>	<b>582</b>	<b>234</b>	<b>151</b>	<b>96</b>	<b>101</b>	

<sup>1</sup> See Coarse Woody Debris Creation maps (Exhibit F pages 10 and 11)



<sup>2</sup> Select approximately 50% of the trees larger and 50% of the trees smaller than the median tree size for the given range unless stand conditions dictate otherwise. If only trees smaller than the appropriate size are available, select trees of the largest size class present. Do not select the largest, most dominant tree within any given area.

1. **Tree Selection** – The Purchaser shall select five hundred eighty-two (582) reserve trees to create CWD by saw-topping, high-girdling, basal-girdling or felling according to the following guidelines. Numbers of trees and tree sizes to be selected, specific to each CWD unit, are displayed in the table above. Placement of trees to be selected by treatment type within the individual treatment units is displayed on the Coarse Woody Debris Creation maps (Exhibit F pages 10 and 11). The locations of the selected trees (individually or in small groups; distance from roads or property line) varies by treatment method; see treatment methods below for additional treatment-specific information concerning tree selection.
  - Only healthy Douglas-fir trees shall be selected for treatment.
  - No trees marked with any existing metal tags shall be selected for treatment.
  - No trees with nests or any nest-like structures of any birds or mammals, or trees with defects such as cavities, platforms, mistletoe infection, or dead, forked/multiple and/or broken tops shall be selected.
  - Selected trees shall be evenly distributed throughout the CWD units. When selecting trees, select approximately fifty (50) percent of the trees larger than the median tree size for the given range, and approximately fifty (50) percent of the trees smaller than the median tree size for the given range unless stand conditions dictate otherwise. If only trees smaller than the appropriate size are available, select trees of the largest size class present. Do not select the largest, most dominant tree within any given area.
  - a. **Saw-topping and High-girdling:** Select healthy appearing Douglas-fir trees with live crown ratios greater than thirty (30) percent and with **average or larger** crown spread. If only trees with smaller live crown ratios than appropriate are available, select trees with the largest crown ratio present. Treatment types and selected trees shall be scattered uniformly throughout the units. Trees selected for saw-topping shall be selected singly. Trees selected for high-girdling shall be selected in groups of three (3) to five (5) trees. Trees selected for saw-topping or high-girdling shall not be located within seventy-five (75) feet of a drivable road (open after use) or a property line boundary where BLM land abuts non-federal ownership (Exhibit F pages 10 and 11).
  - b. **Basal-girdling:** Select healthy Douglas-fir trees with live crown ratios **less** than thirty (30) percent and **smaller** than average crown spread. If only trees with larger live crown ratios than appropriate are available, select appropriately sized trees with the smallest crown ratio present. Selected trees shall be located within the portion of the CWD units designated for basal-girdling and selected in groups of three (3) to five (5) trees. Trees selected for basal-girdling shall not be located within approximately one hundred fifty (150) feet of a drivable

road (open after use) or a property line boundary where BLM land abuts non-federal ownership (Exhibit F pages 10 and 11). Trees selected for basal-girdling shall be those trees which provide minimal amounts or no shade to streams (e.g., north side of stream channel and/or being an area where topography or tree location minimizes the shade afforded to stream by selected tree, such as being located several tree spacings from the stream channel).

- c. **Tree felling:** Select Douglas-fir trees with live crown ratios less than thirty (30) percent and smaller than average crown spread. If only trees with larger live crown ratios than appropriate are available, select appropriately sized trees with the smallest crown ratio present. Selected trees shall be located within the portion of the CWD unit designated for felling and shall be scattered uniformly throughout the unit. Trees selected for felling shall be and selected singly (not in groups). Trees selected for felling shall be located within one hundred (100) feet of the stream channel and selected so that when felled, the portion of the tree in contact with the stream channel would be at least six (6) inches in diameter. Trees selected for felling shall be those trees which provide minimal amounts or no shade to streams (e.g., north side of stream channel and/or being an area where topography or tree location minimizes the shade afforded to stream by selected tree, such as being located several tree spacings from the stream channel).

## 2. CWD Treatments

- a. **Saw-Topping** – severing the treetop within the live crown
1. The Purchaser shall climb and top selected trees at a height of at least sixty (60) feet above the ground at a point where approximately twenty to fifty (20-50) percent of the live crown remains; saw-topping heights shall be varied equally within this placement within the live crown (See Illustration 1). Topping shall be done with power tools (e.g., chainsaws).
  2. The Purchaser shall cut several V-type notches that are a minimum of six (6) cuts into the sawn top surface of the tree, each a minimum of six (6) inches deep.
  3. To the extent practicable, the Purchaser shall retain all green limbs and the largest dead limbs on the treated trees during the climbing and topping operations.
  4. Tree tops shall be completely severed from the tree and fall completely to the ground inside unit boundaries.
  5. To the extent practicable, the Purchaser shall directionally fall tops in order to not damage existing snags, under-story conifers, any tree containing a suspected nest of a bird or mammal, or any tree with defects such as hollow cavities, multiple tops, or decay, and avoid to contact with unburned burn piles and drivable roads.
  6. The Purchaser shall tie two (2) pieces of flagging of a color approved by the Authorized Officer around the bole of each treated tree, one (1) at a height of approximately twenty to thirty (20-30) feet above the ground and another at four and one-half (4.5) feet above the ground (measured from the uphill side of the tree).

7. A small numbered aluminum tag shall be nailed to the base of the treated tree (uphill side). The tree tag number shall be recorded on the Wildlife Tree Data Recording Form.

b. **High-Girdling** – girdling within the live crown

1. The Purchaser shall climb and girdle selected trees within the live crown at a point where approximately twenty to fifty (20-50) percent of the live crown remains below the point of girdling and at a height of at least sixty (60) feet above the ground; girdling heights shall be varied equally within this placement within the live crown. Girdling may be done with a hand tool or power tool and will consist of removing all bark and cambium in a ten to twelve (10-12) inch band completely around the main stem of the tree. (See Illustration #3)
2. Tool cuts must not penetrate more than one-half (0.5) inches into the wood of high-girdled trees.
3. Live limbs below the point of high-girdling shall not be removed. To the extent practicable, the Purchaser shall retain the largest dead limbs on the trees during the climbing and high-girdling operations.
4. The Purchaser shall tie three pieces of flagging of a color approved by the Authorized Officer to each high-girdled tree. One flag shall be tied on a branch visible from the ground near the point of girdle, a second flag shall be tied around the bole of the tree at a height of approximately twenty to thirty (20-30) feet above the ground and a third flag at four and one-half (4.5) feet above the ground (measured from the uphill side of the tree). The two highest flags shall extend at least four (4) feet from the knot.
5. A small numbered aluminum tag shall be nailed to the base of the treated tree (uphill side). The tree tag number shall be recorded on the Wildlife Tree Data Recording Form.

c. **Basal-Girdling**

1. The Purchaser shall basal-girdle selected trees by making three (3) parallel cuts around the bole of the tree between three (3) and four (4) feet above ground level measured on the uphill side of the tree; power tools may be used. Each cut must connect with itself completely around the tree and penetrate through the cambium layer into the wood at least one-half (0.5) inches, but not more than one and one-half (1.5) inches. The distance between the top cut and the bottom cut shall not exceed twelve (12) inches. (See Illustration #2)
2. The Purchaser shall tie a piece of flagging of a color approved by the Authorized Officer around the bole of each treated tree four and one-half (4.5) feet above the ground (measured from the uphill side of the tree).
3. A small numbered aluminum tag shall be nailed to the base of the treated tree (uphill side). The tree tag number shall be recorded on the Wildlife Tree Data Recording Form.

d. **Felling**

1. The Purchaser shall completely sever selected trees from the stump and fall them completely to the ground.
2. Stumps shall be no more than four and one-half (4.5) feet tall measured on the uphill side.
3. No part of a fallen tree shall rest outside of the CWD unit boundaries, or within one hundred fifty (150) feet of any drivable road.
4. Directionally fall trees toward the nearest mapped stream or stream channel.
5. Trees shall be felled into active stream channels only during the Oregon Department of Fish and Wildlife's (ODFW's) in-stream work window (July 15 – September 30) unless a waiver is obtained from ODFW by the BLM.
6. Directionally fall trees away from existing snags, under-story conifers, any tree containing a suspected nest of a bird or mammal, or any green tree with defect such as multiple tops, hollow cavities, or decay.
7. A small numbered aluminum tag shall be nailed to the base of the felled tree. The tree tag number shall be recorded on the Wildlife Tree Data Recording Form.

**3. Documentation**

- a. The Purchaser shall provide the location for all saw-topped, high-girdled, basal-girdled or felled trees by documenting the UTM coordinates using a GPS unit with NAD83 datum, zone 10. If acceptable GPS satellite coverage cannot be obtained at a site, the point shall be hand drawn onto a map and submitted to the Authorized Officer with the Wildlife Tree Data Recording Forms (Illustration #4).
- b. The Purchaser shall provide the Wildlife Tree Data Recording Forms, UTM coordinates, and any hand drawn maps in a digital format once per week to the Authorized Officer for work completed during the previous week.
- c. All information recorded on the Wildlife Tree Data Recording Forms (Illustration #4) shall be legible, clear and reproducible on a black and white copy machine. All documents shall be reviewed by the Purchaser to ensure completeness, legibility, accuracy, and consistency in style before submitting them to the Authorized Officer.

### ILLUSTRATION #1 – Saw-topping within the Live Crown

Cut a V-type notch or a “King’s Crown” (with a minimum of 6 cuts) into the sawn top surface, a minimum of 6 inches deep, to provide for a greater potential of future decay in the treetop. To the extent practicable, retain all green limbs and the largest dead limbs on the treated trees during the climbing and topping operation.

The tree shall be topped at a height of at least 60 feet above the ground at a point where approximately 20% to 50% of the live crown remains. Topping heights shall be varied equally within this placement within the live crown.

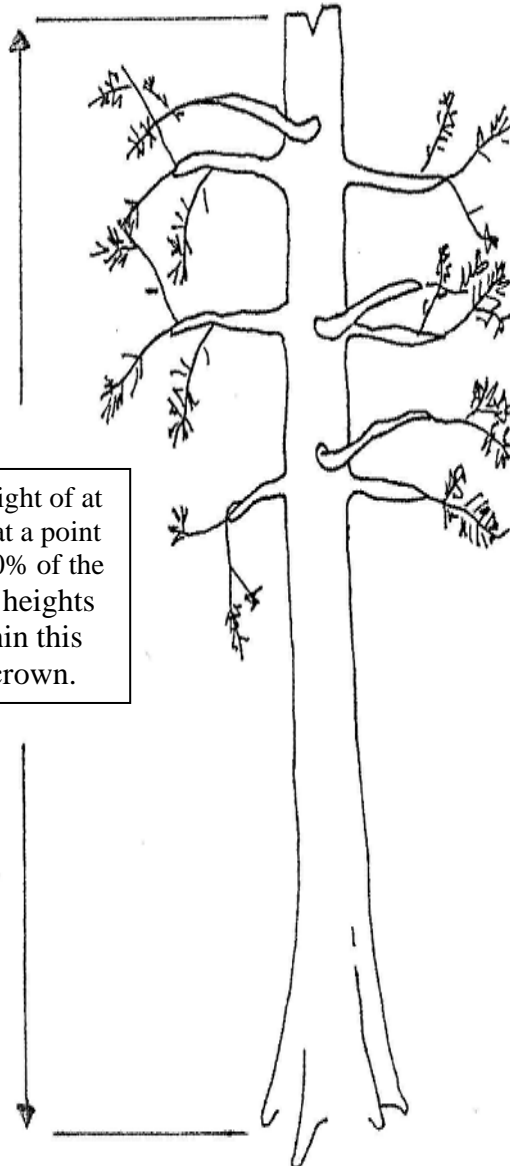

Tie two pieces of flagging around the bole of each saw-topped tree, one at a height of approximately 20-30 feet and one 4.5 feet above the ground. A small numbered aluminum tag shall be nailed to the base of the tree (uphill side).

## Basal-Girdling ILLUSTRATION #2

**Girdling example:** make three (3) parallel unbroken cuts around the tree. The distance between the top and the bottom of the cut shall not exceed twelve inches. Cuts must penetrate at least  $\frac{1}{2}$  inch, but not more than  $1\frac{1}{2}$  inches into the wood of the tree. Trees shall be girdled between 3 and 4 feet from the ground.

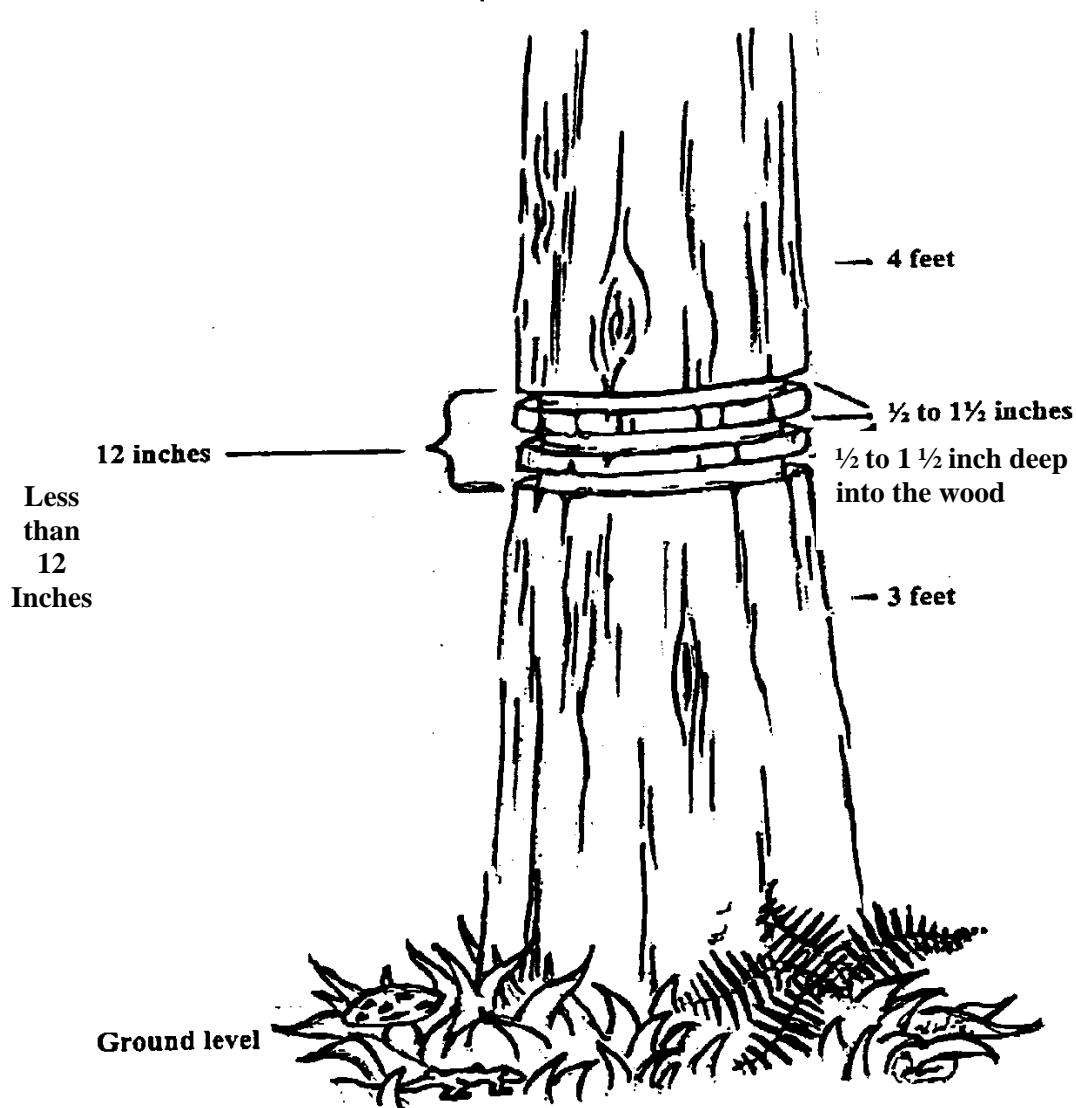

Tie one piece of flagging around the bole of each basal-girdled tree 4.5 feet above the ground.  
A small numbered aluminum tag shall be nailed to the base of the tree (up-hill side).

### Illustration #3 – High-Girdling within the Live Crown

#### Crown Girdling Specifications:

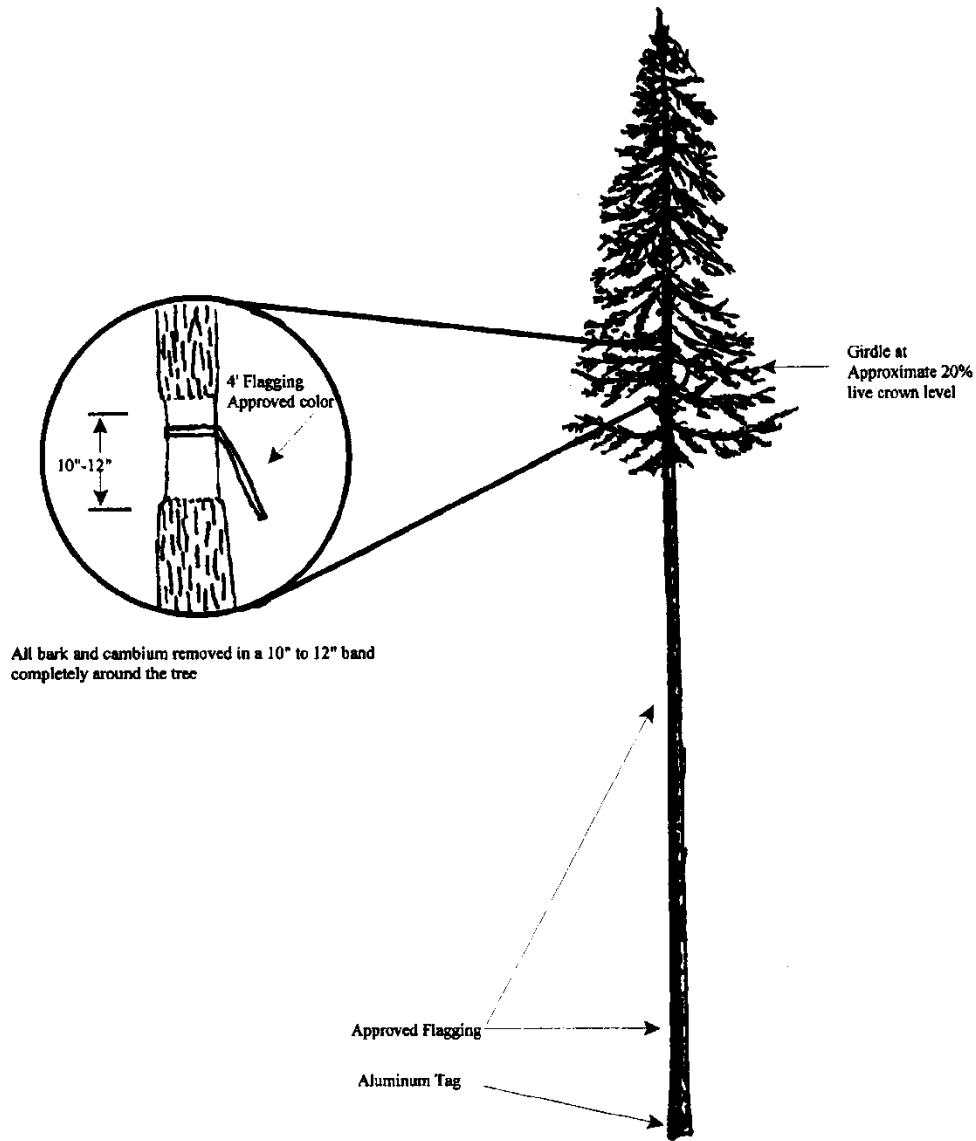

All bark and cambium removed in a 10" to 12" band completely around the tree

To the extent practicable, retain all green limbs and the largest dead limbs on the treated trees below the point of treatment. Treatment heights shall be greater than or equal to 60 feet above the ground at a point in the live crown where 20% to 50% of live branches remain. Girdling heights shall be varied equally within this placement within the live crown. Tie three pieces of flagging around the bole of each high-girdled tree, one at the point of girdling, one at a height of approximately 20-30 feet and one 4.5 feet above the ground. A small numbered aluminum tag shall be nailed to the base of the tree (uphill side).







United States Department of the Interior  
 BUREAU OF LAND MANAGEMENT  
 COARSE WOODY DEBRIS CREATION

Contract No. ORN04-TS-2020.0402  
 Fairchild Timber Sale  
 Exhibit F  
 Page 10 of 11

7/22/2020

T. 2S. R. 6W, Section 10 and 11 W. M. - NORTHWEST OREGON DISTRICT - OREGON

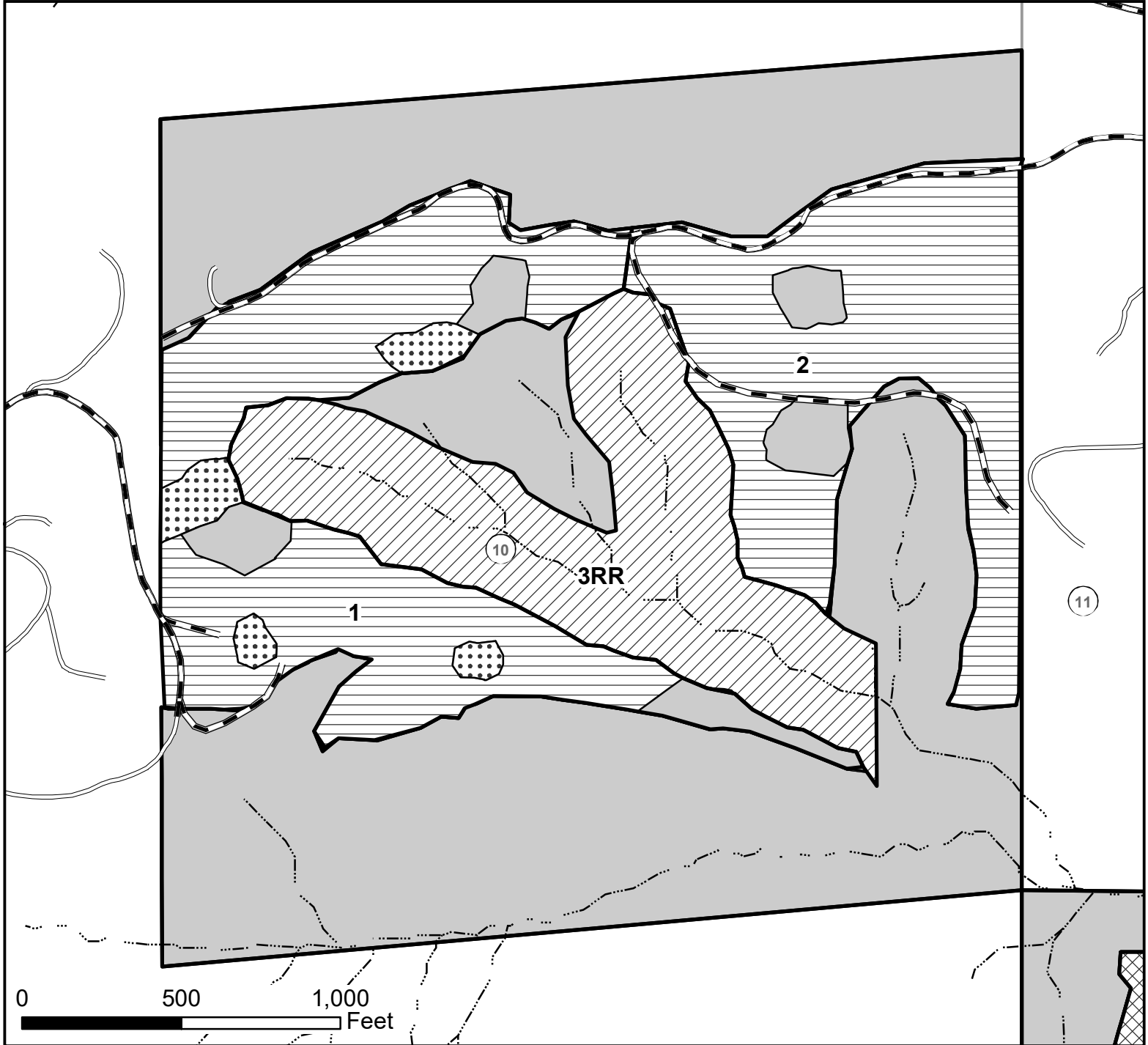

-  Open After Use
-  Existing Roads
-  Streams
-  Sawtop
-  Sawtop, High Girdle
-  Sawtop, High Girdle, Basal Girdle
-  Sawtop, High Girdle, Basal Girdle, Fell

CWD Unit	Acres	Total Trees	Saw-Top	High Girdle	Basal Girdle	Felled	Tree Size to be Selected (inches at DBH)
1	32	32	13	13	6	0	20-28
2	26	26	13	13	0	0	20-28
3RR	25	70	20	20	20	10	Snags: 50% 10-20; Fell: 50% 12-20; ALL: 50% 20-32
4	52	52	52	0	0	0	23-30
6	8	8	8	0	0	0	20-28
7	31	31	13	12	6	0	20-28
8	3	3	3	0	0	0	20-28
9RR	13	45	10	10	9	16	Snags: 50% 10-20; Fell: 50% 12-20; ALL: 50% 20-32
10	52	52	22	20	10	0	20-28
11RR	74	210	45	45	45	75	Snags: 50% 10-20; Fell: 50% 12-20; ALL: 50% 20-32
12	30	30	16	14	0	0	20-28
13	14	14	14	0	0	0	23-30
14	9	9	5	4	0	0	16-26
<b>Totals</b>		<b>582</b>	<b>234</b>	<b>151</b>	<b>96</b>	<b>101</b>	

No warranty is made by the Bureau of Land Management as to the accuracy, reliability, or completeness of these data for individual or aggregate use with other data. Original data were compiled from various sources and may be updated without notification. Note: Boundaries of harvest area and rights-of-ways (ROW) are painted orange and posted. Harvest area acres do not include existing roads. Acres shown on Exhibit A for harvest area have been computed using a S1 mobile mapper and Trimble R1 GNSS Receiver.

Prepared By: dtyler



United States Department of the Interior  
 BUREAU OF LAND MANAGEMENT  
 COARSE WOODY DEBRIS CREATION

Contract No. ORN04-TS-2020.0402  
 Fairchild Timber Sale  
 Exhibit F  
 Page 11 of 11

7/22/2020

T. 2S. R. 6W, Section 11, 13, and 14 W. M. - NORTHWEST OREGON DISTRICT - OREGON

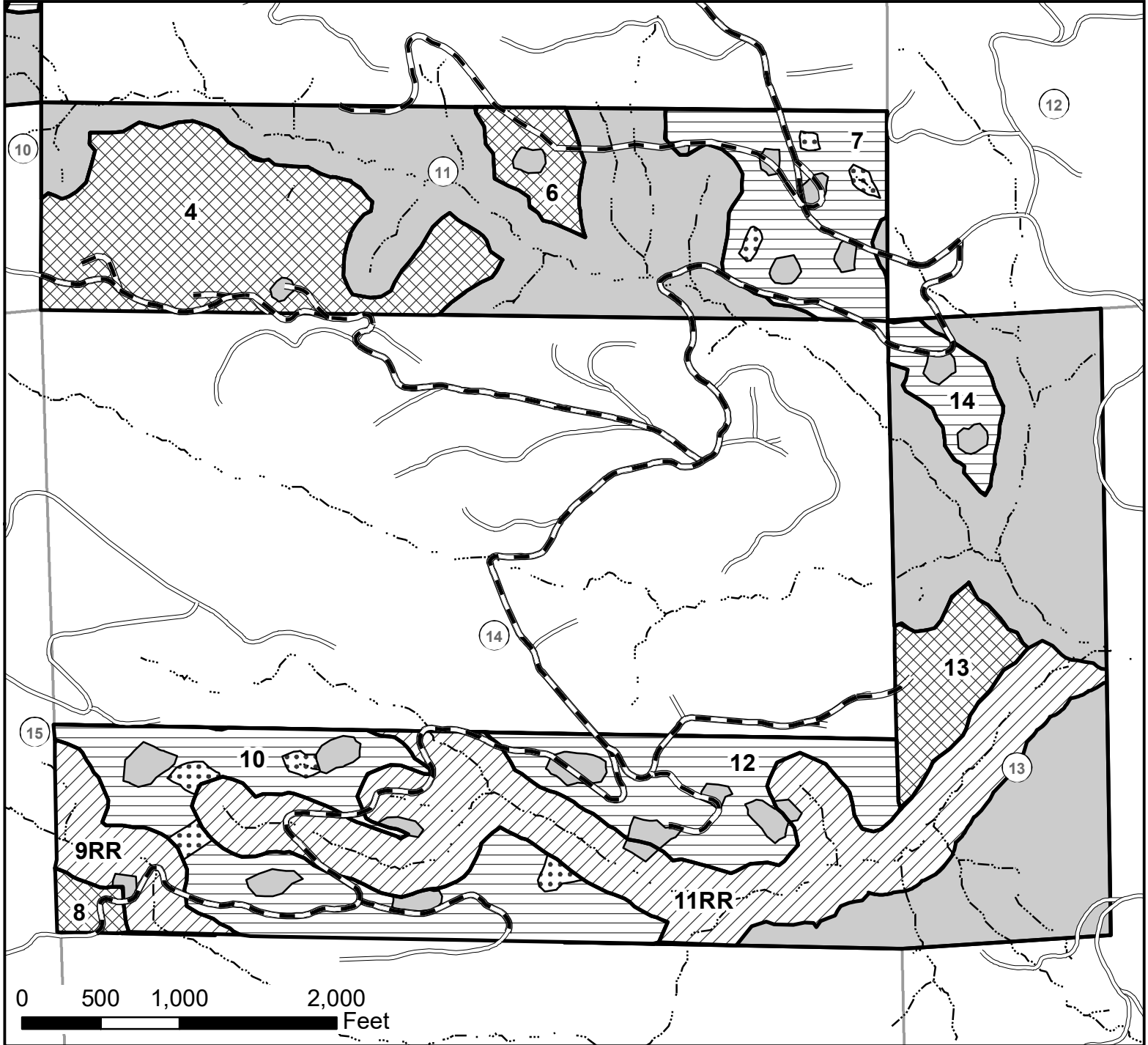

- Open After Use
- Existing Roads
- Streams
- Sawtop
- Sawtop, High Girdle
- Sawtop, High Girdle, Basal Girdle
- Sawtop, High Girdle, Basal Girdle, Fell

CWD Unit	Acres	Total Trees	Saw-Top	High Girdle	Basal Girdle	Felled	Tree Size to be Selected (inches at DBH)
1	32	32	13	13	6	0	20-28
2	26	26	13	13	0	0	20-28
3RR	25	70	20	20	20	10	Snags: 50% 10-20; Fell: 50% 12-20; ALL: 50% 20-32
4	52	52	52	0	0	0	23-30
6	8	8	8	0	0	0	20-28
7	31	31	13	12	6	0	20-28
8	3	3	3	0	0	0	20-28
9RR	13	45	10	10	9	16	Snags: 50% 10-20; Fell: 50% 12-20; ALL: 50% 20-32
10	52	52	22	20	10	0	20-28
11RR	74	210	45	45	45	75	Snags: 50% 10-20; Fell: 50% 12-20; ALL: 50% 20-32
12	30	30	16	14	0	0	20-28
13	14	14	14	0	0	0	23-30
14	9	9	5	4	0	0	16-26
<b>Totals</b>		<b>582</b>	<b>234</b>	<b>151</b>	<b>96</b>	<b>101</b>	

No warranty is made by the Bureau of Land Management as to the accuracy, reliability, or completeness of these data for individual or aggregate use with other data. Original data were compiled from various sources and may be updated without notification. Note: Boundaries of harvest area and rights-of-ways (ROW) are painted orange and posted. Harvest area acres do not include existing roads. Acres shown on Exhibit A for harvest area have been computed using a S1 mobile mapper and Trimble R1 GNSS Receiver. Prepared By: dtyler



**United States  
Department of the Interior  
Bureau of Land Management**

**Timber Appraisal**

---

<b>Sale Name:</b> Fairchild	<b>Sale Date:</b> Wednesday, September 16, 2020
<b>BLM District:</b> NW Oregon DO	<b>Unit of Measure:</b> 16' MBF
<b>Contract #:</b> ORN04-TS-2020.0402	<b>Contract Term:</b> 36 months
<b>Sale Type:</b> Advertised	<b>Contract Mechanism:</b> 5450-3 Sale of Timber - Lump Sum

---

**Content**

**Timber Appraisal Summary  
Stumpage Summary  
Unit Summary  
Stump to Truck  
Transportation  
Engineering Allowances  
Other Allowances**

**Prepared By:** Bryant, William A - 8/7/2020

**Approved By:** -

## Legal Description of Contract Area

Land Status	County	Township	Range	Section	Subdivision	Meridian
O&C	Yamhill	2 S	6 W	10	S1/2NE1/4, N1/2SE1/4	Willamette
O&C	Yamhill	2 S	6 W	11	S1/2SW1/4, S1/2SE1/4	Willamette
O&C	Yamhill	2 S	6 W	13	W1/2NW1/4, NW1/4SW1/4	Willamette
O&C	Yamhill	2 S	6 W	14	N1/2SW1/4, N1/2SE1/4	Willamette

## Species Totals

Species	Net	Gross Merch	Gross	# of Merch Logs	# of Cull Logs	# of Trees
Douglas Fir	10,536.0	10,870.0	10,909.0	142,914	297	26,530
Western Hemlock	79.0	84.0	84.0	1,864	0	786
Bigleaf Maple	55.0	140.0	140.0	2,008	2,962	2,391
Red Alder	23.0	54.0	54.0	570	701	468
Western Redcedar	2.0	3.0	3.0	23	0	13
<b>Totals</b>	<b>10,695.0</b>	<b>11,151.0</b>	<b>11,190.0</b>	<b>147,379</b>	<b>3,960</b>	<b>30,188</b>

## Cutting Area Acres

Regeneration Harvest Acres	Partial Cut Acres	Right of Way Acres	Total Acres	Net Volume per Acre
65.0	215.0	3.0	283.0	37.8

**Logging Costs**

Stump to Truck	\$1,184,808.63
Transportation	\$585,212.57
Road Construction	\$1,293,771.41
Maintenance/Rockwear	\$199,281.70
Road Use	\$21,390.00
Other Allowances	\$47,376.20
<b>Total:</b>	<b>\$3,331,840.51</b>
<b>Total Logging Cost per MBF:</b>	<b>\$311.53</b>

**Utilization Centers**

<u>Location</u>	<u>Distance</u>	<u>% of Net Volume</u>
Willamina	42.0 miles	99 %
Garibaldi	44.0 miles	1 %

**Profit & Risk**

Profit	10 %
Risk	3 %
<b>Total Profit &amp; Risk</b>	<b>13 %</b>

**Tract Features**

<b>Quadratic Mean DBH</b>	16.6 in
<b>Average GM Log</b>	74 bf
<b>Average Volume per Acre</b>	37.8 mbf
<b>Recovery</b>	96 %
<b><u>Net MBF volume:</u></b>	
<b>Green</b>	10,695.0 mbf
<b>Salvage</b>	0 mbf
<b>Export</b>	0 mbf
<b><u>Ground Base Logging:</u></b>	
<b>Percent of Sale Volume</b>	35 %
<b>Average Yarding Slope</b>	30 %
<b>Average Yarding Distance</b>	350 ft
<b><u>Cable Logging:</u></b>	
<b>Percent of Sale Volume</b>	65 %
<b>Average Yarding Slope</b>	55 %
<b>Average Yarding Distance</b>	600 ft
<b><u>Aerial Logging:</u></b>	
<b>Percent of Sale Volume</b>	0 %
<b>Average Yarding Slope</b>	0 %
<b>Average Yarding Distance</b>	0 ft

**Cruise**

<b>Cruise Completed</b>	February 2020
<b>Cruised By</b>	Bill Bryant
<b>Cruise Method</b>	Variable Plot 40 BAF

## Stumpage Computation

Species	# of Trees	Net Volume	Pond Value	(-) Profit & Risk	(-) Logging Costs	(+) Marginal Log Value	Appraised Price/MBF	Appraised Value
Douglas Fir	26,530	10,536.0	\$540.25	\$70.23	\$311.53	\$0.00	\$158.50	\$1,669,956.00
Western Hemlock	786	79.0	\$348.91	\$45.36	\$311.53	\$0.00	\$34.90 *	\$2,757.10
Bigleaf Maple	2,391	55.0	\$260.00	\$33.80	\$311.53	\$0.00	\$26.00 *	\$1,430.00
Red Alder	468	23.0	\$295.67	\$38.44	\$311.53	\$0.00	\$29.60 *	\$680.80
Western Redcedar	13	2.0	\$655.50	\$85.22	\$311.53	\$0.00	\$258.80	\$517.60
<b>Totals</b>	<b>30,188</b>	<b>10,695.0</b>						<b>\$1,675,341.50</b>

\* Minimum Stumpage values were used to compute the Appraised Price/MBF (10% of Pond Value)

## Percent of Volume By Log Grade

Species	No. 1 & 2 Peeler	No. 3 Peeler	Special Mill	No. 2 Sawmill	No. 3 Sawmill	No. 4 Sawmill	Camp Run
Douglas Fir				57.0 %	40.0 %	3.0 %	

Species	Peeler	No. 1 Sawmill	Special Mill	No. 2 Sawmill	No. 3 Sawmill	No. 4 Sawmill	Camp Run
Western Hemlock				36.0 %	55.0 %	9.0 %	

Species	No. 1 Sawmill	No. 2 Sawmill	No. 3 Sawmill	No. 4 Sawmill	No. 5 Sawmill	Camp Run
Bigleaf Maple						100.0 %

Species	No. 1 Sawmill	No. 2 Sawmill	No. 3 Sawmill	No. 4 Sawmill	No. 5 Sawmill	Camp Run
Red Alder						100.0 %

Species	No. 1 Sawmill	No. 2 Sawmill	No. 3 Sawmill	No. 4 Sawmill	Camp Run
Western Redcedar					100.0 %

**Fairchild****Unit Summary****ORN04-TS-2020.0402****Unit: 1****Net Volume/Acre: 37.5 MBF**

Species	Net	Gross Merch	Gross	# of Trees
Douglas Fir	2,294.0	2,366.0	2,373.0	5,771
Western Hemlock	17.0	18.0	18.0	171
Bigleaf Maple	12.0	31.0	31.0	523
Red Alder	5.0	12.0	12.0	102
<b>Totals:</b>	<b>2,328.0</b>	<b>2,427.0</b>	<b>2,434.0</b>	<b>6,567</b>

Regeneration Harvest	0.0
Partial Cut	62.0
Right of Way	0.0
<b>Total Acres:</b>	<b>62.0</b>

**Unit: 2****Net Volume/Acre: 40.0 MBF**

Species	Net	Gross Merch	Gross	# of Trees
Douglas Fir	2,010.0	2,074.0	2,082.0	5,063
Western Hemlock	15.0	16.0	16.0	150
Bigleaf Maple	11.0	26.0	26.0	458
Red Alder	4.0	10.0	10.0	90
<b>Totals:</b>	<b>2,040.0</b>	<b>2,126.0</b>	<b>2,134.0</b>	<b>5,761</b>

Regeneration Harvest	51.0
Partial Cut	0.0
Right of Way	0.0
<b>Total Acres:</b>	<b>51.0</b>

**Unit: 3****Net Volume/Acre: 38.3 MBF**

Species	Net	Gross Merch	Gross	# of Trees
Douglas Fir	1,809.0	1,867.0	1,874.0	4,557
Western Hemlock	14.0	15.0	15.0	135
Bigleaf Maple	10.0	25.0	25.0	413
Red Alder	4.0	9.0	9.0	80
<b>Totals:</b>	<b>1,837.0</b>	<b>1,916.0</b>	<b>1,923.0</b>	<b>5,185</b>

Regeneration Harvest	0.0
Partial Cut	48.0
Right of Way	0.0
<b>Total Acres:</b>	<b>48.0</b>

**Unit: 4**

Species	Net	Gross Merch	Gross	# of Trees
Douglas Fir	4,302.0	4,439.0	4,455.0	10,835
Western Hemlock	32.0	34.0	34.0	321
Bigleaf Maple	21.0	56.0	56.0	969
Red Alder	9.0	22.0	22.0	191
Western Redcedar	2.0	3.0	3.0	13
<b>Totals:</b>	<b>4,366.0</b>	<b>4,554.0</b>	<b>4,570.0</b>	<b>12,329</b>

**Net Volume/Acre: 36.7 MBF**

Regeneration Harvest	14.0
Partial Cut	105.0
Right of Way	0.0
<b>Total Acres:</b>	<b>119.0</b>

**Unit: RW**

Species	Net	Gross Merch	Gross	# of Trees
Douglas Fir	121.0	124.0	125.0	304
Bigleaf Maple	1.0	2.0	2.0	28
Red Alder	1.0	1.0	1.0	5
Western Hemlock	1.0	1.0	1.0	9
<b>Totals:</b>	<b>124.0</b>	<b>128.0</b>	<b>129.0</b>	<b>346</b>

**Net Volume/Acre: 41.3 MBF**

Regeneration Harvest	0.0
Partial Cut	0.0
Right of Way	3.0
<b>Total Acres:</b>	<b>3.0</b>



Total Stump To Truck	Net Volume	\$/MBF
\$1,184,808.63	10,695.0	\$110.78

#### Stump to Truck: Falling, Bucking, Yarding, & Loading

Yarding System	Unit of Measure	# of Units of Measure	\$/Unit of Measure	Total Cost	Remarks
Cable: Medium Yarder	GM MBF	2,587.0	\$137.82	\$356,540.34	cable thin 5 loads/day
Cable: Medium Yarder	GM MBF	4,683.0	\$98.44	\$460,994.52	Cable Regen 7 loads/day
Track Skidder	GM MBF	3,881.0	\$94.17	\$365,473.77	ground thin 7 loads/day
<b>Subtotal</b>				<b>\$1,183,008.63</b>	

#### Additional Costs

Item	Unit of Measure	# of Units of Measure	\$/Unit of Measure	Total Cost	Remarks
Intermediate Support	Each	6.0	\$300.00	\$1,800.00	
<b>Subtotal</b>				<b>\$1,800.00</b>	

#### Additional Moves

Equipment	Unit of Measure	# of Units of Measure	\$/Unit of Measure	Total Cost	Remarks
<b>Subtotal</b>				<b>\$0.00</b>	

**Comments:**  
fuel 3.00/gal.  
5mbf/load

Total	Net Volume	\$/MBF
\$585,212.57	10,695.0	\$54.72

Utilization Center	One Way Mileage	Description	Unit of Measure	# of Units	\$/Unit of Measure	Total Cost	% of Sale Volume
Garibaldi	44.0	Hardwoods	GM MBF	197.0	\$65.31	\$12,866.07	1 %
Willamina	42.0	Conifer	GM MBF	10,954.0	\$52.25	\$572,346.50	99 %

**Comments:**

\$95/hr. 2.75 hr. round trip

5mbf/load conifer

4mbf/load hardwood

**Engineering Allowances**

Total	Net Volume	\$/MBF
\$1,514,443.11	10,695.0	\$141.60

Cost Item	Total Cost
Road Construction:	\$1,293,771.41
Road Maintenance/Rockwear:	\$199,281.70
Road Use Fees:	\$21,390.00

**Comments:**

See engineering appraisal

Total	Net Volume	\$/MBF
\$47,376.20	10,695.0	\$4.43

### Environmental Protection

Cost item	Total Cost
equipment washing	\$400.00
<b>Subtotal</b>	<b>\$400.00</b>

### Miscellaneous

Cost item	Total Cost
Administrative cost CWD	\$3,434.20
Basal Girdle	\$2,688.00
Fell	\$3,232.00
High Girdle	\$10,872.00
Saw Top	\$17,550.00
<b>Subtotal</b>	<b>\$37,776.20</b>

### Slash Disposal & Site Prep

Cost item	Total Cost
Landing Pile Cover, Burn	\$1,200.00
Machine Pile Construct, cover, burn	\$8,000.00
<b>Subtotal</b>	<b>\$9,200.00</b>

#### Comments:

See Fuels and Wildlife appraisals for detailed information



United States Department of the Interior  
 BUREAU OF LAND MANAGEMENT  
 CONTRACT AREA VICINITY MAP

Contract No. ORN04-TS-2020.0402  
 Fairchild Timber Sale  
 Vicinity Map  
 Page 1 of 1

7/1/2020

Northwest Oregon District - Tillamook Field Office

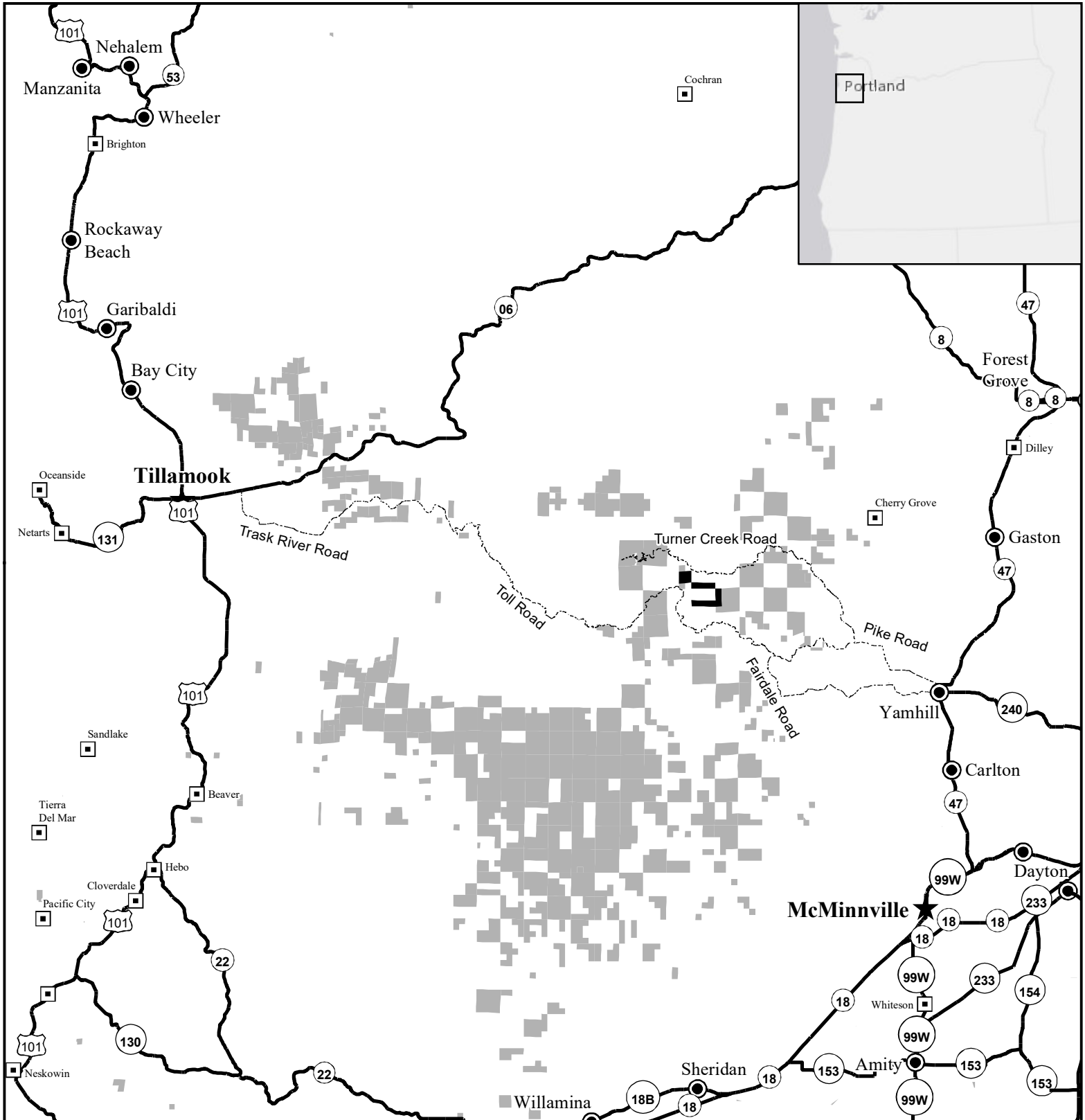

0 5 10 20 Miles

- ★ County Seat
- City, Town, or Village
- Community or Locale
- Highway
- Vicinity Roads
- ▬ Fairchild Contract Area
- BLM Land

No warranty is made by the Bureau of Land Management as to the accuracy, reliability, or completeness of these data for individual or aggregate use with other data. Original data were compiled from various sources and may be updated without notification. Note: Boundaries of harvest area and rights-of-ways (ROW) are painted orange and posted. Harvest area acres do not include existing roads. Acres shown on Exhibit A for harvest area have been computed using a S1 mobile mapper and Trimble R1 GNSS Receiver.