

UNITED STATES
DEPARTMENT OF THE INTERIOR
BUREAU OF LAND MANAGEMENT
Tillamook Field Office
4610 3rd Street
Tillamook, OR 97141

Big Maple Timber Sale
ORN04-TS-2023.0401
Date: October 26, 2022

PROSPECTUS
ORAL AUCTION

THIS IS A PROSPECTUS ONLY. ATTACHMENTS MAY NOT INCLUDE ALL EXHIBITS REFERRED TO IN THE CONTRACT. THE COMPLETE CONTRACT, INCLUDING ALL EXHIBITS, IS AVAILABLE FOR INSPECTION AT THE TILLAMOOK FIELD OFFICE.

NOTICE IS HEREBY GIVEN that the Bureau of Land Management will offer for sale timber as described herein for oral auction, pursuant to Instructions to Bidders, as stated on Form No. 5440-9. **Written and oral bids will be received by the District Manager, or his representative, in the timber sale room at the District Office, 1717 Fabry Road, S.E., Salem, Oregon. Written bids and deposits will be accepted beginning at 8:30 a.m. and the timber sale oral auction will commence at 9:00 a.m., on Wednesday, October 26, 2022.**

THIS PROSPECTUS does not constitute the decision document for purposes of protest and appeal of a forest management decision. Consistent with 43 CFR Subpart 5003.2(b), the date the BLM posts the forest management decision on the BLM's ePlanning website establishes the effective date of the decision for purposes of an administrative appeal. The decision was posted to the BLM's ePlanning website on August 12, 2022, referring to the Coast Creek Timber Management Project, DOI-BLM-ORWA-N040-2020-0001-EA.

AN ENVIRONMENTAL ASSESSMENT was prepared for Big Maple timber sale tract, and a Finding of No Significant Impact has been documented. These documents are available for inspection as background for each timber sale tract at the Tillamook Field Office.

THE VOLUMES LISTED herein are estimates only. The sale volumes listed are based on 16-foot taper breaks which must be taken into consideration if comparisons are made with volume predictions based on other standards. The volumes based on 32-foot taper breaks are shown for comparison purposes. No sale shall be made for less than the advertised appraised price. The Purchaser shall be liable for the total purchase price, without regard to the amount bid per unit, even though the quantity of timber cut or removed or designated for taking is more or less than the estimated volume or quantity so listed.

THIS TIMBER SALE has been cruised based upon Eastside Scribner board foot measure. The minimum bid figures shown by species are dollars per thousand board feet (MBF). The minimum bid increment will be \$0.10 per MBF.

A PERFORMANCE BOND in an amount not less than 20 percent of the total purchase price will be required for all contracts of \$2,500 or more. A minimum performance bond of not less than \$500 will be required for all installment contracts less than \$2,500.

PRE-AWARD QUALIFICATIONS. The high bidder may be required to furnish information to determine the ability to perform the obligations of the contract. If the high bidder is determined not qualified, responsible or

refuses to respond within fifteen (15) days of a request for information pertaining to qualifications, the contract may be offered and awarded for the high bid to the highest of the bidders who is qualified, responsible, and willing to accept the contract.

LOG EXPORT AND SUBSTITUTION: All timber sales, including timber from Federal rights-of-ways, shall be subject to the restrictions relating to the export and substitution of unprocessed timber from the United States in accordance with P.L. 94-165 and 43 CFR 5400 and 5420, as amended.

LOG EXPORT AND SUBSTITUTION RESTRICTIONS: Excepting Port-Orford-cedar, all timber offered for sale hereunder is restricted from export from the United States in the form of unprocessed timber and is prohibited from being used as a substitute for exported private timber. The BLM has revised the log export restrictions special provision to reduce the log branding and painting requirements. The new requirements include branding of one end of all logs with a scaling diameter of over 10 inches. All loads of 11 logs or more, regardless of the diameter of the logs, will have a minimum of 10 logs branded on one end. All logs will be branded on loads of 10 logs or less. One end of all branded logs will be marked with yellow paint. At the discretion of the Contracting Officer, the Purchaser may be required to brand and paint all logs. The Purchaser shall bear any increased costs for log branding and painting.

CONTRACT MODIFICATION, SUSPENSION OR TERMINATION: A revised Special Provision has been added to the contract which enables the Contracting Officer to suspend the contract to facilitate protection of certain plant or animal species, and/or to modify or terminate the contract when necessary to: (1) Comply with the Endangered Species Act or to prevent incidental take of northern spotted owls in accordance with management direction in the Record of Decision (ROD) and Resource Management Plan (RMP), or; (2) Comply with a court order, or; (3) Protect species which were identified for protection through survey and manage and/or protection buffer standards and guidelines or management direction established in the ROD and RMP.

ADDITIONAL INFORMATION concerning this timber sale tract is available at the above District Office. A copy of the timber sale contract is also available for inspection at the District Office. The prospectus for this sale is also available online at: <https://www.blm.gov/programs/natural-resources/forests-and-woodlands/timber-sales>. The prospectus includes maps and tables that cannot be made Section 508 compliant. For help with its data or information, please contact the Tillamook Field Office at 503-815-1109.

TIMBER SALE NOTICE

NORTHWEST OREGON DISTRICT
TILLAMOOK FIELD OFFICE
COLUMBIA MASTER UNIT

Sale Date: October 26, 2022

CONTRACT NO.: ORN04-TS-2023.0401, Big Maple Timber Sale, Lump Sum
YAMHILL COUNTY, OREGON: O&C: **Oral Bid**
BID DEPOSIT REQUIRED: **\$204,300.00**

All timber designated for cutting on: SW¹/₄NE¹/₄, NW¹/₄, NE¹/₄SW¹/₄ **Sec. 33**, T. 4 S., R. 7 W.; SE¹/₄NW¹/₄ **Sec. 03**; S¹/₂NE¹/₄, W¹/₂SW¹/₄, N¹/₂SE¹/₄ **Sec. 08**; N¹/₂NW¹/₄ **Sec. 09**, T. 5 S., R. 7 W., WM., Oregon.

THIS TIMBER SALE HAS BEEN CRUISED BASED UPON EASTSIDE SCRIBNER MEASURE.

Minimum bid figures shown by species are dollars per thousand board feet (MBF). The minimum bid increment will be \$0.10 per MBF.

Approx. No. Merchantable Trees	Est. Vol. MBF 32' Log	Species	Est. Vol. MBF 16' Log	Appraised Price Per MBF	Estimated Volume Times Appraised Price
14,241	5,413	Douglas-fir	6,643	\$307.50	\$2,042,722.50
40	2.2	bigleaf maple	3	\$29.40*	\$88.20
14,281	5,415.2	Totals	6,646		\$2,042,810.70

*Minimum Stumpage values were used to compute the Appraised Price/MBF (10% of Pond Value)

LOG EXPORT AND SUBSTITUTION RESTRICTIONS: All timber offered for sale hereunder is restricted from export from the United States in the form of unprocessed timber and prohibited from substitution of exported private timber.

CRUISE INFORMATION: The timber volumes for the harvest units were based on a variable plot cruise for estimating the board foot volume of trees. Plots were measured using a 40 basal area factor (BAF) for regen units, and a 20 (BAF) in all thinning harvest units. None of the total sale volume is salvage material. For merchantable Douglas- fir trees the average DBHOB is 18.1 inches; the average gross merchantable log contains 111 bf (board feet); the total gross volume is approximately 6,937 MBF; and 96% recovery is expected.

CUTTING AREA: Six (6) units totaling approximately one hundred forty-nine (149) acres, of which one hundred twenty-three (123) acres shall be regeneration harvest and twenty-six (26) acres shall be partial cut harvest. In addition, approximately two (2) acres of right-of-way shall be cut. Acres shown on Exhibit A have been computed using S1 Mobile Mapper, ArcGIS Field Maps, and Trimble R1 GNSS receiver. Acreage was calculated based on Global Positioning System traverse procedures including differential correction.

DURATION OF CONTRACT: Contract length will be 36 months for cutting and removal of timber.

OPTIONAL CONTRIBUTION (Sec. 42.kk.): The Purchaser will have the option of performing Coarse Woody Debris or contributing eighteen thousand four hundred ninety and 88/100 dollars (\$18,490.88) in lieu thereof. The option must be declared *prior* to contract execution.

LOCATION: The contract area is located approximately seven (7) air miles northwest of Willamina, Oregon. Starting in Willamina, Oregon, head west on NE Main Street for .3 miles. Continue onto Willamina Creek Road for 6 miles. Slight left onto Coast Creek Road and follow for 1.3 miles. Keep left to stay on Coast Creek Road and follow for 1.2 miles. Slight right onto the 5-7-10.1 Road for .5 miles. Keep left onto the 5-7-9.3 road and continue on for .2 miles where you will encounter Unit 4 of the Timber Sale. Consult a project location map.

ACCESS AND ROAD MAINTENANCE:

Access is provided by Yamhill County, Giustina Land and Timber Company, Stimson Lumber Company, and the Bureau of Land Management (BLM) controlled roads. All roads (except Road 4-7-22.0 (Bible Creek Road) and 4-7-27.0 (Bald Mountain Road)) used in conjunction with this sale will be maintained by the Purchaser. Purchaser will be required to pay a rockwear obligation of nine thousand five hundred seventy-three and 30/100 dollars (\$9,573.30) to the Government, pay a maintenance fee of three thousand five hundred eleven and 43/100 dollars (\$3,511.43) to the Government, and spread **525 CY** crushed rock on BLM roads for maintenance.

In the use of Giustina Land and Timber Company controlled roads, under Right-of-Way Agreement No. S-682A (OR066504) and as shown on Exhibit E, the Purchaser will be required to enter into a license agreement which requires: (a) Purchaser maintenance of all Giustina Land and Timber Company controlled roads, (b) Purchaser pay a road use obligation fee of forty-three thousand nineteen and 77/100 dollars (\$43,019.77), (c) Purchaser pay a rockwear fee of eight hundred seventy-two and 39/100 dollars (\$872.39), (d) Purchaser provide proof of insurance with limits of \$1,000,000/\$1,000,000/\$1,000,000 and a performance bond of \$10,000. Prior to the use of said roads, the Purchaser shall furnish the Authorized Officer a copy of the executed license agreement.

In the use of Stimson Lumber Company controlled roads, under Right-of-Way Agreement No. S-796 (OR045077) and as shown on Exhibit E, the Purchaser will be required to enter into a license agreement which requires: (a) Purchaser maintenance of all Stimson Lumber Company controlled roads, (b) Purchaser pay a rockwear fee of four hundred sixty-two and 25/100 dollars (\$462.25), (c) Purchaser provide proof of insurance with limits of \$1,000,000/\$1,000,000/\$1,000,000 and a performance bond of \$10,000. Prior to the use of said roads, the Purchaser shall furnish the Authorized Officer a copy of the executed license agreement.

In the use of 5-7-10.2 (Segment F), Purchaser shall pay Hampton Lumber Company one thousand seven hundred fifty and 00/100 dollars (\$1,750.00) for merchantable timber to be removed (before cutting of timber). Purchaser shall supply verification of receipt of payment to Hampton Lumber Co. upon request of the Authorized Officer.

In the use of Yamhill County controlled roads, which include all of Coast Creek County Road (gravel section), 5-7-10.1 (Joe White Road), and 5-7-10.2 (Canada Creek Road), the Purchaser will be required to maintain segments of Yamhill County controlled roads, as shown on Exhibit E. The designated haul route will be on Gilbert Creek Road to Coast Creek Road to Willamina Creek Road towards Willamina.

No additional road use obligation fees will be charged for modified volume hauled over Giustina Land and Timber controlled roads. Rockwear fees have been calculated using timber volumes based on the actual BLM timber sale cruise volume. Additional fees for rockwear will be calculated at the agreed upon rates (in the license agreements) for additional timber volume for non-BLM controlled roads. Additional fees for rockwear (and maintenance on the 4-7-22.0 (Bible Creek Road) and 4-7-27.0 (Bald Mountain Road)) will be calculated at the current rate for additional timber volume for BLM controlled roads and be charged to the Purchaser. Purchaser maintenance shall include frequent blading and shaping of road surface; ditch, culvert and catch basin cleaning; removal of minor slides and other debris. Roads shall be left in a condition to withstand adverse

weather at the end of the seasonal operations.

Purchaser shall also spread **345 CY** crushed rock on non-BLM roads as needed and instructed by the Authorized Officer.

ROAD CONSTRUCTION AND RENOVATION: The Purchaser will be required to do all work set forth below. The Purchaser shall supply all material unless otherwise indicated.

1. New Road Construction:

Road 4-7-28.3: 2,108 feet, 14-foot ditched/crowned subgrade, natural surfacing, Clearing and Grubbing, Blading and Compacting Surface, Construct ditchouts, lead-off ditches, turnarounds, and landings as marked. Spread 6" Jaw Run Base Spot Rock as marked. Spread 1-1/2"-0" Crushed Spot Rock as marked. Place Bedding/Backfill Rock as marked. Install 2 Poly Pipe cross-drains. Install 2 Culvert markers.

Road 4-7-28.3a: 115 feet, 14-foot ditched/crowned subgrade, natural surfacing, Clearing and Grubbing, Blading and Compacting Surface.

Road 4-7-28.3b: 161 feet, 14-foot ditched/crowned subgrade, natural surfacing, Clearing and Grubbing, Blading and Compacting Surface.

Road 4-7-33.5: 1,212 feet, 14-foot ditched/crowned subgrade (Sta. 0+00 – 6+42) & 14-foot outsloped subgrade (Sta. 6+42 – 12+12), natural surfacing, Clearing and Grubbing, Blading and Compacting Surface, Construct truck turnaround, ditchouts, lead-off ditches, and landing as marked. Do NOT cut RTV trees (marked with aluminum tag).

Road 4-7-33.6: 98 feet, 14-foot outsloped subgrade, natural surfacing, Clearing and Grubbing, Blading and Compacting Surface, Construct ditchouts and landing as marked.

Road 4-7-33.7: 268 feet, 14-foot ditched/crowned subgrade, natural surfacing, Clearing and Grubbing, Blading and Compacting Surface, Construct ditchouts, waste area, turnaround and landing as marked.

2. Renovation:

Road 4-7-21.0: 0.833 miles, 16-foot ditched/crowned subgrade, Rocked surfacing, Brushing with some Clearing and Grubbing, Blading and Compacting Surface, Clean Culverts, Ditchline Re-establishment by bunching and hauling, Construct turnouts, ditchouts, lead-off ditches, waste areas, and sediment catch basins with straw bales as marked, Spread 6" Jaw Run Base Spot Rock as marked, Spread 1-1/2"-0" Crushed Spot Rock as marked and needed, Place Bedding/Backfill Rock as marked, Install 2 Poly Pipes (cross-drains), Install 2 Poly Downspout Pipes, and Install 5 Culvert markers.

Road 4-7-28.2: 0.774 miles, 14-foot ditched/crowned subgrade, Rocked surfacing, Brushing with some Clearing and Grubbing, Blading and Compacting Surface, Clean Culverts, Ditchline Re-establishment by bunching and hauling, Construct turnouts, ditchouts, lead-off ditches, waste areas, sediment catch basins with straw bales, and place straw bales in ditchline for existing sediments traps as marked, Spread 1-1/2"-0" Crushed Spot Rock as needed, Place Class 3 RipRap as energy dissipater as marked, and Install 6 Culvert markers.

Road 4-7-33.2: 2,935 feet, 14-foot ditched/crowned subgrade (Sta. 1+06 – 18+36 & 21+75 – 29+35) & 14-foot outsloped subgrade (Sta. 0+00 – 1+06 & 18+36 – 21+75), natural surfacing, Clearing and Grubbing, Blading and Compacting Surface, Ditchline Re-establishment by bunching and hauling, Construct ditchouts, lead-off ditches, waste areas, turnarounds, turnouts, and landings as marked, Spread 6" Jaw Run Base Spot Rock as marked, Spread 1-1/2"-0" Crushed Spot Rock as marked, Place Bedding/Backfill Rock as marked, Place Class 5 RipRap as fill armor as marked, Place Class 5 RipRap as fill armor/stabilization wall as marked, Install 8 Poly Pipes (cross-

drains), Replace 2 Stream Pipes (Aluminized Steel Pipes) (Remove/Relocate one of these pipes and backfill trench of removed pipe) and Install 10 Culvert markers.

- Road 5-7-3.1: 120 feet, 14-foot outsloped subgrade, Rocked surfacing, Brushing with some Clearing and Grubbing, Blading and Compacting Surface, Construct turnaround, and landing as marked. Spread 1-1/2"-0" Crushed Spot Rock as marked and needed.
- Road 5-7-8.1: 0.901 miles, 16-foot ditched/crowned subgrade, Rock surfacing, Brushing with some Clearing and Grubbing, Blading and Compacting Surface, Clean Culverts, Ditchline Re-establishment by bunching and hauling, Construct turnouts, waste areas, ditchouts, lead-off ditches, and sediment catch basin with straw bale as marked, Spread 6" Jaw Run Base Spot Rock as marked, Spread 1-1/2"- 0" Crushed Spot Rock as marked and needed, Place Bedding/Backfill Rock as marked, Place Class 3 RipRap for fill armor/energy dissipater as marked, Replace 6 and Install 1 Poly Pipe (cross-drains), Replace 1 Stream Pipe (Poly Pipe), Install 1 Poly Downspout Pipe, and Install 9 Culvert markers.
- Road 5-7-8.2: 0.368 miles, 14-foot ditched/crowned subgrade, Rock surfacing, Brushing with some Clearing and Grubbing, Blading and Compacting Surface, Clean Culverts, Ditchline Re-establishment by bunching and hauling, Construct ditchouts, lead-off ditches, and waste area as marked, Spread 6" Jaw Run Base Spot Rock as marked, Spread 1-1/2"-0" Crushed Spot Rock as marked and needed, Place Bedding/Backfill Rock as marked, Replace 1 and install 1 Poly Pipes (cross-drains), and Install 3 Culvert markers.
- Road 5-7-8.6: 1,203 feet, 14-foot ditched/crowned subgrade, natural surfacing, Brushing with some Clearing and Grubbing, Blading and Compacting Surface, Remove existing waterbars and barriers as marked, Ditchline Re-establishment by bunching and hauling, Construct ditchouts, lead-off ditches, waste area, turnaround, turnaround/roadside landing, and landing as marked, Spread 6" Jaw Run Base Spot Rock as marked, Spread 1-1/2"-0" Crushed Spot Rock as marked, Place Bedding/Backfill Rock as marked, Install 1 Poly Pipe (cross-drain), and Install 1 Culvert marker.
- Road 5-7-8.7: 1,723 feet, 14-foot ditched/crowned subgrade, natural surfacing, Brushing with some Clearing and Grubbing, Blading and Compacting Surface, Remove existing waterbars as marked, Ditchline Re-establishment by bunching and hauling, Construct ditchouts, lead-off ditches, waste area, turnaround, turnaround/roadside landing, turnout/roadside landing, and landing as marked, Spread 6" Jaw Run Base Spot Rock as marked, Spread 1-1/2"-0" Crushed Spot Rock as marked, Place Bedding/Backfill Rock as marked, Install 2 Poly Pipes (cross-drains), and Install 2 Culvert markers.
- Road 5-7-9.0: 1.871 miles, 16-foot ditched/crowned subgrade, Rock surfacing, Brushing with some Clearing and Grubbing, Blading and Compacting Surface, Clean Culverts, Ditchline Re-establishment by bunching and hauling, Construct ditchouts, lead-off ditches, waterdip, turnouts, turnaround, waste areas, and sediment catch basins with straw bales as marked, blocking of old road after using as waste area, Spread 6" Jaw Run Base Spot Rock as marked, Spread 1-1/2"- 0" Crushed Spot Rock as marked and needed, Place Bedding/Backfill Rock as marked, Place Pit-Run as fill armor as marked, Place Class 5 RipRap for fill armor/stabilization wall as marked, Place Class 5 RipRap as fill armor as marked, Place Class 5 RipRap as energy dissipater as marked, Replace 3 and Install 2 Poly Pipe (cross-drains), Replace 3 Stream Pipes (Aluminized Steel Pipes) and Install 9 Culvert markers.
- Road 5-7-9.3: 2,123 feet, 14-foot ditched/crowned subgrade, Rock surfacing, Brushing with some Clearing and Grubbing, Blading and Compacting Surface, Ditchline Re-establishment by bunching and hauling, Construct ditchouts, lead-off ditches, turnouts, turnarounds, roadside landings, bank widening for junction/ditchline, and sediment catch basins with straw bales as marked, Spread 6" Jaw Run Base Spot Rock as marked. Spread 1-1/2"-0" Crushed Spot Rock as

marked and needed. Place Bedding/Backfill Rock as marked, Place Class 5 RipRap for stabilization wall/energy dissipater as marked, install 4 Poly Pipes (cross-drains), Replace 1 Stream Pipe (Poly Pipe), Install 5 Culvert marker.

Road 5-7-10.0: 0.527 miles, 16-foot ditched/crowned subgrade, Rock surfacing, Brushing with some Clearing and Grubbing, Blading and Compacting Surface, Ditchline Re-establishment by bunching and hauling, Construct turnouts, waste areas, 2' x 2' ditchline (MP 0.014 – 0.052), ditchouts, and lead-off ditches as marked, Spread 6" Jaw Run Base Spot Rock as marked, Spread 1-1/2"-0" Crushed Spot Rock as marked and needed, Place Bedding/Backfill Rock as marked, Place Pit-Run Rock as ditchline armor as marked, Place Class 5 RipRap as dissipater and fill armor as marked, Remove/relocate one existing CMP and backfill trench, Install 1 poly pipe (cross-drain), Replace 2 stream pipes (aluminized steel), Install 6 Culvert markers. **Utility locates will need to be done before any grading or excavation work. Coordination with homeowner shall occur before replacing Pipe @ MP 0.237.**

Road 5-7-10.1: 0.489 miles, 14-foot ditched/crowned subgrade (MP 0.036 – 0.489) & 14-foot outsloped subgrade (MP 0.000 – 0.036), Rock surfacing, Brushing with some Clearing and Grubbing, Blading and Compacting Surface, Clean Culverts, Ditchline Re-establishment by bunching and hauling, Construct turnout, waste areas, ditchouts, lead-off ditches, and 2' x 2' ditchline (MP 0.423 – 0.431), sediment catch basins with straw bales as marked, Spread 6" Jaw Run Base Spot Rock as marked, Spread 1-1/2"-0" Crushed Spot Rock as marked and needed, Place Bedding/Backfill Rock as marked, Place Pit-Run Rock as ditchline armor as marked, Replace 2 stream pipes (Poly pipe and aluminized steel), Install 1 Culvert marker and re-use 1 Culvert marker.

Road 5-7-10.2: 11,434 feet, 14-foot ditched/crowned subgrade (Sta. 4+85 – 114+34) & 14-foot outsloped subgrade (Sta. 0+00 – 4+85), Rock surfacing, Brushing with some Clearing and Grubbing, Blading and Compacting Surface, Clean Culverts, Ditchline Re-establishment by bunching and hauling, Construct turnouts, waste areas, ditchouts, lead-off ditches, turnarounds, fill slope repair, sediment catch basins with straw bales as marked, Spread 6" Jaw Run Base Spot Rock as marked, Spread 1-1/2"-0" Crushed Spot Rock as marked and needed, Place Bedding/Backfill Rock as marked, Place Pit-Run Rock as fill armor as marked, Place Class 5 RipRap as fill armor/stabilization wall, Place Class 5 RipRap as fill armor, Place Class 5 RipRap as outlet dissipater/stabilization wall, Place Class 5 RipRap as Stabilization Wall, Place Class 5 RipRap as Energy Dissipater, Replace 2 and install 7 poly pipes (cross-drains), Replace 5 and install 2 stream pipes (Poly pipe and aluminized steel), Re-attach 2 existing half-rounds, cut length off existing outlet @ Sta. 38+36 as marked, Fix Inlet of existing CMP @ Sta. 73+73 as marked, Install 20 Culvert markers and re-use 2 Culvert markers.

Road 5-7-10.3: 1.266 miles, 14-foot ditched/crowned subgrade (MP 0.027 – 1.266) & 14-foot outsloped subgrade (Sta. 0.000 – 0.027), Rock surfacing, Brushing with some Clearing and Grubbing, Blading and Compacting Surface, Clean Culverts, Ditchline Re-establishment by bunching and hauling, Construct turnouts, waste areas, ditchouts, lead-off ditches, turnarounds, roadside landings, and landing, sediment catch basins with straw bales as marked, Spread 6" Jaw Run Base Spot Rock as marked, Spread 1-1/2"-0" Crushed Spot Rock as marked and needed, Place Bedding/Backfill Rock as marked, Remove/relocate one existing CMP and backfill trench, Install 7 poly pipes (cross-drains), Install 2 downspouts, Install 6 Culvert markers and re-use 1 Culvert marker.

Coast Creek County Road: 1.199 miles, 16-foot ditched/crowned subgrade, Rock surfacing, Brushing, Blading and Compacting Surface, Clean Culverts, Ditchline Re-establishment by

bunching and hauling, Construct ditchouts as marked and needed, Spread 1-½”-0” Crushed Spot Rock as needed. **Utility locates will need to be done before any grading or excavation work.**

3. Estimated Quantities:

a. Clearing, Grubbing, and Brushing:

12.56 acres of Clearing and Grubbing
11.37 miles of Brushing

b. Culverts:

1,725 feet of 18-inch Corrugated Plastic Pipe (CPP) – Type S--(48 Pipes)
60 feet of 18-inch Corrugated Plastic Pipe (CPP) – Type C--(5 Pipes)
330 feet of 24-inch Corrugated Plastic Pipe (CPP) – Type S-- (9 Pipes)
494 feet of 36-inch 16-gauge Aluminized Steel Pipe (CMP) – (10 Pipes)
40 feet of 48inch 14-gauge Aluminized Steel Pipe (CMP) – (1 Pipe)
Neoprene sleeves or flat gaskets for 42-inch Pipe Bands Installations
85 Metal “T” Post Inlet Markers
4 Re-used Inlet Markers (existing)
16 Metal “T” Posts for Downspouts/Existing Half-Round Installations
33 Straw Bales for Sediment Catch Basin w/ Bale Installations
2 Straw Bales for Existing Sediment Catch Basins

c. Aggregate Material:

<u>Quantity</u>	<u>Description</u>
2,040 cubic yards	1 ½” minus crushed rock – Construction Rock
1,495 cubic yards	6” jaw run crushed rock – Construction Rock
1,180 cubic yards	1 ½” minus crushed rock – Culvert Bedding Material
105 cubic yards	Pit-Run rock – Construction Rock
525 cubic yards	1 ½” minus crushed rock – BLM Maintenance Rock
345 cubic yards	1 ½” minus crushed rock – Non-BLM Maintenance Rock
20 cubic yards	Rip-Rap – Class 3
390 cubic yards	Rip-Rap – Class 5

Rock Source: All 1-½”-0”, 6” Jaw Run, Pit-Run Rock, and Riprap (Class 3&5) – Commercial Source

Other:

Compaction of all final grades will be required.

Right of way debris will be disposed of by scattering adjacent to all roads, outside of clearing limits.

All roads shall be decommissioned as follows:

The Purchaser shall decommission the 4-7-28.3 (Sta. 1+00 – 21+08), 4-7-28.3a, 4-7-28.3b, 4-7-33.5, 4-7-33.6, & 4-7-33.7 by subsoiling, installing non-drivable waterbars, scattering slash, removing culverts, grass seeding, and blocking. The Purchaser shall stabilize the 4-7-33.2, 5-7-3.1, 5-7-8.6, 5-7-8.7, 5-7-9.0 (MP 1.583 – 1.871), 5-7-9.3 (Sta. 8+56 – 21+23), 5-7-10.2 (Sta. 96+69 – 114+34), and 5-7-10.3 (MP 1.050 – 1.266) by installing drivable waterdips.

Grass seeding will be required on all newly disturbed areas. Grass seed will be furnished by the Government.

Straw mulch will be required on all disturbed/seeded soils that are wet and/or within 50 feet each side of “Live stream” locations and all disposal sites. Grass straw for mulch will be furnished by the Government.

All waste from re-establishing ditchlines on rock surfaced roads shall be bunched and end-hauled to

designated waste area.

All slide removal material shall be end-hauled to designated waste areas.

All culverts removed upon road renovation shall be disposed of in a legal fashion off of BLM Land.

All culverts removed upon road decommissioning shall be salvaged and delivered to the BLM

Maintenance Facility at the SW ¼ of Section 5, T. 3 S., R. 6 W., W.M.

SEASONAL RESTRICTION MATRIX:

Restricted Times are Shaded

Activity	JAN		FEB		MAR		APR		MAY		JUN		JUL		AUG		SEP		OCT		NOV		DEC	
	1	16	1	16	1	16	1	16	1	16	1	16	1	16	1	16	1	16	1	16	1	16	1	16
Mechanized falling and Ground-Based yarding																								
Cable yarding, log haul, rock haul, and water haul																								
Roadside brushing																								
Road renovation, construction, and decommissioning																								
In-Stream Activities in the North Yamhill River watershed																								
In-Stream Activities in the Nestucca watershed																								

SPECIAL PROVISIONS TO NOTE

Notwithstanding the provisions of Section 4, the cutting of timber in Units 1 and 5, and the right-of-way cutting associated with roads 4-7-28.3, 4-7-28.3a, 4-7-28.3b, 4-7-33.2, 4-7-33.5, 4-7-33.6, 4-7-33.7, 5-7-8.6, and 5-7-8.7 shall be completed **before December 1, 2024**.

TIMBER SALE CONTRACT SPECIAL PROVISIONS

Sec. 41. Timber and Area Reservation ProvisionsRESERVED

- a. All timber in the reserve and clump areas shown on Exhibit A, and all trees that are painted orange and posted, which mark the boundaries of the timber sale units.
- b. All trees marked with orange paint above and below stump height within the boundaries of the timber sale units shown on Exhibit A.
- c. All conifer trees less than seven (7) inches diameter at breast height (dbh), all Pacific madrone, Pacific yew, bitter cherry, Pacific dogwood, Oregon ash, and Oregon white oak in the Sale Areas shown on Exhibit. If any are felled, they shall be retained on site.
- d. Existing down logs and snags in the Sale Areas shown on Exhibit A, which do not present a safety hazard. All down logs and felled snags shall be retained on site.
- e. Trees felled within road rights-of-way, which are marked with yellow paint above and below stump height shall remain on site and be placed outside of the road prism.

Sec. 42. Special ProvisionsLOGGING

- a. Before beginning operations on the Contract Area for the first time or after a shutdown of seven (7) or more days, the Purchaser shall notify the Authorized Officer in writing of the date they plan to begin operations. This written notification must be received by the Authorized Officer no less than seven (7) days prior to the date the Purchaser plans to begin or resume operations. The Purchaser shall also notify the Authorized Officer in writing if they intend to cease operations for any period of seven (7) or more days.
- b. Prior to the commencement of operations, the Purchaser shall obtain from the Authorized Officer approval of a written operations and logging plan commensurate with the terms and conditions of the contract which shall include measures needed to assure protection of the environment and watershed. A pre-work conference between the Purchaser's authorized representative and the Authorized Officer must be held before the logging plan will be approved. All logging shall be done in accordance with the approved logging plan. The Purchaser shall provide a minimum of seven (7) days notice when requesting the scheduling of a pre-work conference.
- c. Notwithstanding the provisions of Section 4, the cutting of timber in Units 1 and 5, and the right-of-way cutting associated with roads 4-7-28.3, 4-7-28.3a, 4-7-28.3b, 4-7-33.2, 4-7-33.5, 4-7-33.6, 4-7-33.7, 5-7-8.6, and 5-7-8.7 shall be completed before December 1, 2024.
- d. Excessive damage to reserve timber, as determined by the Authorized Officer, will result

in suspension of yarding and felling operations until corrective measures to prevent further damages have been approved by the Authorized Officer.

e. No falling, yarding, or loading is permitted in or through the reserve areas, shown on Exhibit A, unless otherwise approved by the Authorized Officer.

f. Prior to attaching any logging equipment to a reserve tree, the Purchaser shall obtain approval from the Authorized Officer, and shall take precautions to protect the tree from damage as directed by the Authorized Officer.

g. At all landings, all non-merchantable logs more than eight (8) inches in diameter at the large end and exceeding eight (8) feet in length shall be scattered, or decked at a location designated by the Authorized Officer.

h. In skyline harvest areas all yarding shall be done with a skyline or similar cable system equipped with a carriage capable of yarding one thousand (1,000) feet slope distance from the landing and at least seventy-five (75) feet laterally from the skyline to the designated sky road. The carriage shall be capable of being held in position on the skyline during all lateral yarding and shall be able to pass intermediate support jacks as required. The leading end of all logs shall be transported free of the ground during yarding. Full suspension is required within fifty (50) feet of streams. The rigging of tail or lift trees, intermediate supports and use of tail holds outside the Sale Areas shall be required where necessary to meet this requirement. Space designated skyline corridors at a minimum of one hundred fifty (150) feet apart unless otherwise agreed to in writing by the Authorized Officer.

i. Ground-based operations are limited to slopes of thirty-five (35) percent or less. The Authorized Officer may approve the use of specialized, ground-based, mechanized equipment (machines specifically designed to operate on slopes greater than 35%) on slopes of fifty (50) percent or less, except within two hundred ten (210) feet of streams. All skidding shall be done by equipment operated entirely on skid trails that have been approved by the Authorized Officer and use existing skid trails where available. The area composed of skid trails shall not exceed fifteen (15) percent of the total yarding area within a unit. Excavation on designated skid trails shall be limited to a maximum cut of one (1) foot unless otherwise approved by the Authorized Officer. The Purchaser shall directionally fall trees into the lead with the skidding direction and winch or carry the logs to the skid trails. Temporary logging roads, skid trails, and harvester/forwarder trails would be water barred and blocked as directed by the Authorized Officer, after each operating season before the fall wet season begins. Temporary logging roads, skid trails, and harvester/forwarder trails will be de-compacted/tilled and covered with slash as directed by the Authorized Officer.

j. Before cutting and removing any trees necessary to facilitate logging in the Sale Areas shown on Exhibit A, the Purchaser shall identify the location of skid trails, cable yarding roads, and tail hold, tieback, guy line, lift, intermediate support, and danger trees on the ground in a manner approved by the Authorized Officer at the pre-work conference, and documented in the Logging Plan. Said Purchaser identification of trees to be cut and removed does not constitute authority to proceed with cutting and removal. In addition, before proceeding the following conditions must be met:

1. All skid roads and/or cable yarding roads upon which timber is identified by the Purchaser to be cut and removed in accordance with this special provision must be necessary for

the safe and expeditious removal of timber sold under this contract and shall be limited to the minimum width necessary for yarding of logs with a minimum of damage to reserve trees, however, unless otherwise approved in writing by the Contracting Officer, the width of each skid road and/or cable yarding road shall be limited to twelve (12) feet.

2. The Purchaser may immediately cut and remove additional timber to clear skid trails and cable yarding roads; and provide tail hold, tieback, guy line, lift and intermediate support trees when the trees have been marked with blue or green paint above and below stump height by the Authorized Officer and thereby approved for cutting and removal by the Authorized Officer. When trees are marked with yellow paint above and below stump height they may be cut but must remain on site. The volume of the timber to be sold will be determined by the Authorized Officer in accordance with Bureau of Land Management prescribed procedures. No timber may be cut or removed under terms of this provision unless sufficient installment payments have been made in accordance with Sec. 3(b) of the contract or sufficient bonding has been provided in accordance with Sec. 3(d) of the contract.

3. The Purchaser agrees that sale of this additional timber shall be accomplished by a unilateral modification of the contract executed by the Contracting Officer and that such timber shall be sold at the unit prices shown in Exhibit B of this contract unless: the value of the timber must be reappraised subject to the terms for contract extension set forth in Sec. 9. of the contract; or, the Authorized Officer determines that the tree species are not listed in Exhibit B of this contract and otherwise reserved in Sec. 41. of the contract or any tree that exceeds forty (40) inches dbh shall be appraised and sold by bilateral modification of the contract at current fair market value in accordance with Sec. 8. of the contract.

4. This authorization for the Purchaser to cut and remove additional timber prior to the execution of a modification may be withdrawn by the Contracting Officer if the Authorized Officer determines that the Purchaser has cut and removed any tree not previously marked and approved for cutting by the Authorized Officer, which under Sec. 10. of the contract constitutes a violation of the contract and under Sec. 13. of the contract may constitute a trespass rendering the Purchaser liable for damages under applicable law.

5. If authorization is withdrawn, the Contracting Officer shall issue a written notice to the Purchaser that the sale of additional timber under this special provision is no longer approved. In this case, the Purchaser shall inform the Authorized Officer at least one (1) working day prior to the need for cutting and removing any additional timber, and execute a bilateral modification prior to cutting for such additional approved timber at the unit prices shown in Exhibit B of the contract or in accordance with Sec. 8. or Sec. 9. of the contract as determined by the Authorized Officer in accordance with this provision. The Contracting Officer may issue a written order to the Purchaser to suspend, delay, or interrupt any or all contract work for the period of time deemed necessary and appropriate for the Government to safely measure and mark additional timber.

SAFETY

k. Purchaser's operations shall facilitate BLM's safe and practical inspection of

Purchaser's operations and BLM's conduct of other official duties on Contract Area. Purchaser has all responsibility for compliance with safety requirements for Purchaser's employees, contractors and subcontractors.

In the event that the Authorized Officer identifies a conflict between the requirements of this contract or agreed upon methods of proceeding hereunder and State or Federal safety requirements, the contract may be modified. If the cost of such contract modification is of a substantial nature (\$2,000.00 or more), the Purchaser may request, in writing, an adjustment in the Total Purchase Price specified in Sec. 2. of the timber sale contract, as amended, to compensate for the changed conditions.

Unless otherwise specified in writing, when operations are in progress adjacent to or on roads and/or trails in the harvest unit area, Purchaser shall furnish, install, and maintain all temporary traffic controls that provide the road or trail user with adequate warning of and protection from hazardous or potentially hazardous conditions associated with its operations. Purchaser shall prepare a Traffic Control Plan, which the Purchaser has determined is compliant with state and local OSHA and Transportation standards no later than the pre-work meeting and prior to commencing operations. Traffic control devices shall be appropriate to current operating and/or weather conditions and shall be covered or removed when not needed. Flagmen and devices shall be as specified in state OSHA and Transportation standards for logging roads or the "Manual on Uniform Traffic Control Devices for Streets and Highways" (MUTCD) published by the U.S. Department of Transportation - Federal Highway Administration. Included in the Traffic Control Plan, Purchaser shall note traffic control device locations on a Purchaser-produced copy of the contract Exhibit A Map.

SEASONAL RESTRICTIONS

l. No mechanized falling or ground based equipment operation within harvest units shown on Exhibit A during the wet season (generally October 16 of one calendar year to May 31 of the following calendar year) and during periods of wet soil conditions as determined by the Authorized Officer.

m. No cable yarding, log hauling, water hauling, or rock hauling on roads shown on Exhibit C during the wet season (generally October 16 of one calendar year to May 31 of the following calendar year) and during periods of wet soil conditions as determined by Authorized Officer.

n. No road renovation, road construction, road improvement, or road decommissioning (except roadside brushing, which is permitted year-round), shown on Exhibit C, shall be conducted during the wet season (generally between October 16 of one calendar year to May 31 of the following calendar year), or during periods of wet soil conditions during the dry season as determined by Authorized Officer.

o. No road maintenance, as shown on Exhibit E, and described in Exhibit D, shall be conducted during periods of wet soil conditions as determined by the Authorized Officer.

p. No work required in live streams shall be conducted between October 1 of one calendar year and July 14 of the following calendar year in the North Yamhill River watershed, both days inclusive, and between September 16 of one calendar year and June 30 of the following calendar year

in the Nestucca watershed, both days inclusive, unless BLM receives a waiver from the Oregon Department of Fish and Wildlife, and is approved by the Authorized Officer.

ROAD CONSTRUCTION, RENOVATION, IMPROVEMENT, MAINTENANCE AND USE

q. The Purchaser shall haul only on the designated haul route, as shown on Exhibit E, unless an alternative route is approved by the Authorized Officer. The designated haul route for Unit 1 is out Bible Creek Road to Bald Mountain Road towards Willamina. The designated haul route for Units 2 through 6 is out Coast Creek Road towards Willamina.

r. The Purchaser shall construct natural surfaced roads: 4-7-28.3, 4-7-28.3A, 4-7-28.3B, 4-7-33.5, 4-7-33.6, and 4-7-33.7. The Purchaser shall renovate natural surfaced roads: 4-7-33.2, 5-7-8.6, and 5-7-8.7. The Purchaser shall renovate rocked surfaced roads: 4-7-21.0, 4-7-28.2, 5-7-3.1, 5-7-8.1, 5-7-8.2, 5-7-9.0, 5-7-9.3, 5-7-10.0, 5-7-10.1, 5-7-10.2, 5-7-10.3, and Coast Creek County Road. Construction and renovation shall be done in strict accordance with the plans and specifications shown on Exhibit C, which is attached hereto and made a part hereof.

s. Any required construction, renovation, and improvement shall be completed and accepted prior to the removal of any timber, except right-of-way timber, over the road.

t. The Purchaser shall decommission 4-7-28.3 (Sta. 1+00 – 21+08), 4-7-28.3A, 4-7-28.3B, 4-7-33.5, 4-7-33.6, and 4-7-33.7, as shown on Exhibit C, by subsoiling, installing non-drivable waterbars, scattering slash, removing culverts, spreading grass seed, and blocking. The Purchaser shall stabilize 4-7-33.2, 5-7-3.1, 5-7-8.6, 5-7-8.7, 5-7-9.0 (MP 1.583 – 1.871), 5-7-9.3 (Sta. 8+56 – 21+23), 5-7-10.2 (Sta. 96+69 – 114+34), and 5-7-10.3 (MP 1.050 – 1.266) as shown on Exhibit C, by installing drivable waterdips. Subsoiling shall consist of loosening the soil to a depth of eighteen (18) inches utilizing excavator attachments, log loader tongs, or other approved equipment acceptable to the Authorized Officer. No subsoiling shall be required where the road traverses rock outcroppings. All natural water courses shall be opened to prevent erosion of the road. Barriers shall be constructed and clearing debris shall be placed on and around the barriers so as to prevent further use of the road by vehicles as shown on Exhibit C. Decommissioning and stabilization shall be completed within thirty (30) days of completion of yarding and hauling operations on that road.

u. The Purchaser is authorized to use the roads listed below and shown on Exhibit E which are under the jurisdiction of the Bureau of Land Management for the removal of Government timber sold under the terms of this contract and/or the hauling of rock and water as required in Exhibit C, Exhibit D, and Exhibit E provided the Purchaser complies with the condition set forth in Sections 42.v.

Road No. and Segment	Length Used	Road Control	Road Surface Type	Maintenance Responsibility
4-7-21.0 (Seg. A1-B)	0.833 mi.	BLM	Rocked	Purchaser
4-7-28.3	2,108 ft.	BLM	Natural	Purchaser
4-7-28.3A	115 ft.	BLM	Natural	Purchaser
4-7-28.3B	161 ft.	BLM	Natural	Purchaser

4-7-33.2 (Seg. A2-A7)	2,935 ft.	BLM	Natural	Purchaser
4-7-33.5	1,212 ft.	BLM	Natural	Purchaser
4-7-33.6	98 ft.	BLM	Natural	Purchaser
4-7-33.7	268 ft.	BLM	Natural	Purchaser
5-7-3.1	120 ft.	BLM	Rocked	Purchaser
5-7-8.1 (Seg. A)	0.901 mi.	BLM	Rocked	Purchaser
5-7-8.2 (Seg. A1-A2)	0.368 mi.	BLM	Rocked	Purchaser
5-7-8.6 (Seg. A1-A2)	1,203 ft.	BLM	Natural	Purchaser
5-7-8.7	1,723 ft.	BLM	Natural	Purchaser
5-7-9.0 (Seg. A-F3)	1.871 mi.	BLM	Rocked	Purchaser
5-7-9.3	2,123 ft.	BLM	Rocked	Purchaser
5-7-10.0 (Seg. A1-A2)	0.527 mi.	BLM	Rocked	Purchaser
5-7-10.3 (Seg. B1-B4)	0.490 mi.	BLM	Rocked	Purchaser
Bible Creek Road	1.335 mi.	BLM	Paved	BLM
Bald Mountain Road	1.137 mi.	BLM	Paved	BLM

v. The Purchaser shall perform any road repair and maintenance work on roads used, under the terms of Exhibit D, “Road Maintenance Specifications” of this contract which is attached hereto and made a part hereof. Purchaser shall spread **525** cubic yards of crushed rock on BLM controlled roads as directed by the Authorized Officer and as part of maintenance requirements. Purchaser shall also pay a rockwear fee of nine thousand five hundred seventy-three and 30/100 (\$9,573.30) dollars to the Government. Additional fees for rockwear will be calculated at the current rate for additional timber volume for BLM controlled roads and be charged to the Purchaser, and be paid prior to contract termination. Purchaser shall also pay a maintenance fee of three thousand five hundred eleven and 43/100 (\$3,511.43) dollars to the Government. Additional fees for maintenance will be calculated at the current rate for additional timber volume for BLM controlled roads and be charged to the Purchaser, and be paid prior to contract termination.

w. In the use of the roads listed below and shown on Exhibit E, the Purchaser shall comply with the conditions of Right-of-Way and Road Use Agreement S-682A (OR066504) between the United States of America and Giustina Land & Timber Co. The Purchaser will be required to enter into a license agreement with Giustina Land & Timber Co. prior to commencement of operations. The Purchaser shall furnish to the Authorized Officer a copy of the required executed license agreement. The license agreement conditions include: 1) Purchaser pay a road use lump sum amount of forty-three thousand nineteen and 77/100 (\$43,019.77) dollars. Road use fees have been calculated using the actual BLM timber sale cruise volume. 2) Purchaser pays a rockwear fee to Giustina Land & Timber Co of eight hundred seventy-two and 39/100 (\$872.39) dollars. Rockwear fees have been calculated using the actual BLM timber sale cruise volume. Additional fees for rockwear will be calculated at the agreed upon rates (in the license agreement) for additional timber volume for non-BLM controlled roads. 3) The Purchaser shall perform any road repair and maintenance work on road 4-7-28.2 (Seg. A-B) under the terms of Exhibit D, “Road Maintenance Specifications”, of this contract which is attached hereto and made a part hereof. 4) Default by the Purchaser of said Right-of-Way and Road Use Agreement or any license agreement executed pursuant thereto, shall be considered a violation of this contract. The amount of unpaid fees shall be considered as the amount of damage suffered by the Government as a result of the violation of this provision. The Purchaser will be required to carry liability insurance with the limits of \$1,000,000/\$1,000,000/\$1,000,000 and a performance bond of \$10,000.

Road No. and Segment	Length Used	Road Control	Road Surface Type	Maintenance Responsibility
4-7-28.2 (Seg. A-B)	0.774 mi.	Giustina	Rocked	Purchaser

x. In the use of the roads listed below and shown on Exhibit E, the Purchaser shall comply with the conditions of Right-of-Way and Road Use Agreement S-796 (OR045077) between the United States of America and Weyerhaeuser Timber Holding, Inc. The Purchaser will be required to enter into a license agreement with **Stimson Lumber Co.** prior to commencement of operations. The Purchaser shall furnish to the Authorized Officer a copy of the required executed license agreement. The license agreement conditions include: 1) Purchaser pays a rockwear fee to Stimson Lumber Co. of four hundred sixty-two and 25/100 (\$462.25) dollars. Rockwear fees have been calculated using the actual BLM timber sale cruise volume. Additional fees for rockwear will be calculated at the agreed upon rates (in the license agreement) for additional timber volume for non-BLM controlled roads. 2) The Purchaser shall perform any road repair and maintenance work on road 5-7-10.3 (Seg. A1-A2) under the terms of Exhibit D, "Road Maintenance Specifications", of this contract which is attached hereto and made a part hereof. 3) Default by the Purchaser of said Right-of-Way and Road Use Agreement or any license agreement executed pursuant thereto, shall be considered a violation of this contract. The amount of unpaid fees shall be considered as the amount of damage suffered by the Government as a result of the violation of this provision. The Purchaser will be required to carry liability insurance with the limits of \$1,000,000/\$1,000,000/\$1,000,000 and a performance bond of \$10,000.

Road No. and Segment	Length Used	Road Control	Road Surface Type	Maintenance Responsibility
5-7-10.3 (Seg. A1-A2)	0.776	Stimson	Rocked	Purchaser

y. The Purchaser is authorized to use the roads listed below and shown on Exhibit E for the removal of Government timber sold and rock hauled under the terms of this contract. The Purchaser shall perform any road repair and maintenance work on the roads listed below under the terms of Exhibit D, "Road Maintenance Specifications", of this contract which is attached hereto and made a part hereof.

Road No. and Segment	Length Used	Road Control	Road Surface Type	Maintenance Responsibility
Coast Creek Road	1.199 mi.	County	Rocked	Purchaser
5-7-10.1 (Seg. A)	0.489 mi.	County	Rocked	Purchaser
5-7-10.2 (Seg. A-H)	11,434 ft.	County	Rocked	Purchaser

z. In the use of the road listed below and shown on Exhibit E, the Purchaser will be required to remove 21 merchantable trees on Hampton Lumber Co. land. The Purchaser will be required to pay to Hampton Lumber Co. one thousand seven hundred fifty and 00/100 (\$1,750.00) dollars for the timber prior to cutting of such timber. Purchaser shall supply verification of receipt of payment to Hampton Lumber Co. upon request of the Authorized Officer.

Road No. and Segment	Length Used	Road Control	Road Surface Type	Maintenance Responsibility
5-7-10.2 (Seg. F)	1,315 ft	County	Rocked	Purchaser

aa. The Purchaser agrees that if they request to use any other private road, subject of a right-of-way agreement with the Government for the removal of Government timber sold under the terms of this contract, and is approved by the Authorized Officer, Purchaser shall request and agree to the modification of this contract to provide for such use and for allowances for amortization of the Government's shares of the capital investment of any such road.

bb. With the prior written approval of the Authorized Officer, the Purchaser may arrange for cooperative maintenance with other users of roads included in Exhibit E; provided, that such cooperative arrangement shall not relieve the Purchaser of his liability for the maintenance and repair of such roads resulting from wear or damage, in accordance with this contract. The Purchaser shall furnish the Authorized Officer a copy of any cooperative maintenance agreements entered into with other users of these roads.

cc. The Purchaser shall be responsible for repair of any damage to roads or structures caused by the use of overweight or over-dimension vehicles or equipment: (1) without written approval; (2) in violation of the conditions of a written approval; or, (3) in a negligent manner. The amount of actual damage shall be determined by the Authorized Officer following a technical inspection and evaluation.

dd. The Purchaser shall perform any road repair and maintenance work on roads used (and designated as Purchaser Maintenance), under the terms of Exhibit D, "Road Maintenance Specifications", of this contract which is attached hereto and made a part hereof. Purchaser shall spread **345** cubic yards of crushed rock on non-BLM roads used for this timber sale, as directed by the Authorized Officer as part of maintenance requirements.

ENVIRONMENTAL PROTECTION

ee. In order to prevent the spread of noxious weeds, the Purchaser shall pressure wash all road construction equipment (except dump trucks) and wash all ground-based logging equipment that will be used off of existing roads, as well as loaders and mechanically propelled brush cutters, prior to each entry onto the BLM Land shown on Exhibit A, as directed by the Authorized Officer. Cleaning shall be defined as removal of all dirt, grease, plant parts and material that may carry noxious weed seeds.

ff. The Purchaser shall immediately discontinue specified construction or timber harvesting operations upon written notice from the Contracting Officer that:

- (1) threatened or endangered plants or animals protected under the Endangered Species Act of 1973, as amended, may be affected by the operation, and a determination is made that consultation or reinitiation of consultation is required concerning the species prior to continuing operation, or;
- (2) when, in order to comply with the Endangered Species Act, or to prevent incidental take of northern spotted owls in accordance with management direction in the Record of Decision (ROD) and Resource Management Plan (RMP), or to protect occupied marbled murrelet sites in accordance with management direction of the ROD and RMP, the

Contracting Officer determines it may be necessary to modify or terminate the contract, or;

- (3) Federal proposed, Federal candidate, Bureau sensitive or State listed species protected under BLM Manual 6840 - Special Status Species Management - have been identified, and a determination is made that continued operations would affect the species or its habitat, or;
- (4) when, in order to comply with a court order, which enjoins operations on the sale or otherwise requires the Bureau of Land Management to suspend operations, or;
- (5) when, in order to comply with a court order, the Contracting Officer determines it may be necessary to modify or terminate the contract, or;
- (6) when, in order to comply with a stay or other remedy issued by the Interior Board of Land Appeals (IBLA) the Contracting Officer determines it may be necessary to modify or terminate the contract, or;
- (7) species have been discovered which were identified for protection in accordance with management direction established in the ROD and RMP, and the Contracting Officer determines that continued operations would affect the species or its habitat, or;
- (8) when, in order to protect species which were identified for protection in accordance with management direction established in the ROD and RMP, the Contracting Officer determines it may be necessary to modify or terminate the contract.

Those operations necessary for a safe removal of personnel and equipment from the contract area and those directed by the Contracting Officer, which are required in order to leave the contract area in an acceptable condition will be permitted. Discontinued operations may be resumed upon receipt of written instructions and authorization by the Contracting Officer.

During any period of suspension, the Purchaser may withdraw performance and payment bond coverage aside from that deemed necessary by the Authorized Officer to secure cut and/or removed timber for which the Bureau of Land Management has not received payment, and/or unfulfilled contract requirements associated with harvest operations that have already occurred and associated post-harvest requirements.

In the event of a suspension period or a combination of suspension periods that exceed a total of 30 days, the First Installment held on deposit may be temporarily reduced upon the written request of the Purchaser. For the period of suspension extending beyond 30 days, the First Installment on deposit may be reduced to five (5) percent of the First Installment amount listed in Section 3.b. of the contract. Any First Installment amount temporarily reduced may be refunded or transferred to another BLM contract at the request of the Purchaser. However, if the Purchaser has outstanding debt owing the United States, the Contracting Officer must first apply the amount of First Installment that could be refunded to the debt owed in accordance with the Debt Collection Improvement Act, as amended (31 USC 3710, et seq.). Upon Purchaser's receipt of a bill for collection and written notice from the Contracting Officer lifting

the suspension, the Purchaser shall restore the First Installment to the full amount shown in Section 3.b. of the contract within 15 days after the bill for collection is issued, subject to Section 3.j. of the contract. The Purchaser shall not resume contract operations until the First Installment amount is fully restored.

In the event of a suspension period or a combination of suspension periods that exceed a total of 30 days, the unamortized Out-of-Pocket Expenses for road or other construction required pursuant to Exhibit C of the contract shall be refunded or transferred to another BLM contract at the request of the Purchaser. Upon written notice from the Contracting Officer lifting the suspension, the Purchaser shall reimburse the Government the amounts refunded or transferred. The Purchaser may choose to pay this reimbursement at once or in installments payable at the same time as payments are due for the timber under the contract and in amounts approximately equal to the expenses associated with the timber for which payment is due.

In the event that operating time is lost as a result of the incorporation of additional contract requirements, or delays due to Endangered Species Act consultation with the U.S. Fish and Wildlife Service or U.S. National Marine Fisheries Service, court-ordered injunctions, or an IBLA issued stay or remedy, the Purchaser agrees that an extension of time, without reappraisal, will constitute a full and complete remedy for any claim that delays due to the suspension hindered performance of the contract or resulted in damages of any kind to the Purchaser.

The Contracting Officer may determine that it is necessary to modify the contract or terminate the cutting and removal rights under the contract in order to comply with the Endangered Species Act, prevent incidental take of northern spotted owls in accordance with the ROD and RMP, protect occupied marbled murrelet sites in accordance with the ROD and RMP, protect species that have been discovered which were identified for protection in accordance with management direction established in the ROD and RMP, or comply with a court order or an IBLA issued stay or remedy. Following the issuance of a written notice that cutting and removal rights will be terminated, the Purchaser will be permitted to remove timber cut under the contract, if allowed by the Endangered Species Act, if able to proceed without causing incidental take of northern spotted owls in accordance with the ROD and RMP, consistent with marbled murrelet occupied site protection in accordance with the ROD and RMP, if consistent with species protection in accordance with management direction established in the ROD and RMP, or if consistent with a court order or an IBLA issued stay or remedy.

In the event the contract is modified or cutting and removal rights are terminated under this subsection, the Purchaser agrees that the liability of the United States shall be limited to the actual costs incurred by the Purchaser which have not been amortized by timber removed from the contract area. This calculation of liability shall utilize actual Purchaser costs and Government estimates of timber volumes. At the Authorized Officer's request, the Purchaser agrees to provide documentation of the actual costs incurred in the performance of the contract. In addition, the Purchaser shall be released from the obligation to pay the contract price for any timber which is not authorized to be removed from the contract area.

The Purchaser specifically and expressly waives any right to claim damages, other than those described in the preceding paragraphs, based on an alleged breach of any duty to the Purchaser, whether express or implied, in regard to the manner in which the Government defended the

litigation which resulted in the court order affecting the operation of the contract. This waiver also extends to any claims based on effects on the operation of the contract that arise from litigation against another agency. Furthermore, the Purchaser specifically acknowledges and agrees that a court ruling that the Government violated the Administrative Procedures Act cannot be interpreted, in itself, to mean that the Government had not acted reasonably in regard to its duties to the Purchaser under this contract.

FIRE PREVENTION

gg. Primarily for purposes of fire prevention and control, the Purchaser shall, prior to the operation of power driven equipment in construction or logging operations under this contract during the fire season or periods of fire danger, prepare a fire prevention and control plan to the satisfaction of the Authorized Officer. Purchaser shall take such measures for prevention and suppression of fire on the contract area and other adjacent Government lands used or traversed by Purchaser in connection with operations as are required by applicable laws and regulations. However, when in the opinion of the Authorized Officer, weather and other conditions affecting fire incidence and control make special precautions necessary to protect the contract area and said Government lands, Purchaser shall take such additional or other fire prevention and control measures as may be required by the Authorized Officer. The Purchaser shall comply with Oregon Department of Forestry Industrial Fire Precaution Level (IFPL) I Fire Season requirements. At IFPL II and III, additional fire prevention and control provisions may be added as determined by the Authorized Officer and specified in written instructions to the Purchaser to mitigate dry fuel and weather conditions.

LOGGING RESIDUE REDUCTION

hh. In addition to the requirements of Sec. 15 of this contract, and notwithstanding the Purchasers satisfactory compliance with State laws and regulations regarding offsetting or abating the additional fire hazard created by this operation and the States willingness to release the Purchaser from liability for such hazard, the Purchaser shall remain responsible to the Government for performance of the following hazard reduction measure(s) required by this contract: Perform logging residue reduction and site preparation work on approximately one hundred five (105) acres of harvest area located within harvest units. The required work shall consist of any treatment or combination of treatments, as determined by the Authorized Officer and specified in writing by the Contracting Officer. The number of acres of each treatment shall be determined by the Authorized Officer. Prior to commencement of any operation under this Section of the contract, a slash disposal and pre-work conference between the purchaser's representative and the Authorized Officer must be held at a location designated by the Authorized Officer. The number of acres of each treatment shall be determined by the Authorized Officer. All slash disposal shall be done in accordance with the plans developed at this pre-work conference. Slash, as defined for this section, shall mean all material (brush, limbs, tops, unmerchantable stems, and chunks) severed or knocked over as a result of purchasers operations under the terms of this contract.

1. Excavator pile and burn slash within ground-based portion of regeneration harvest units and along roads as directed by the Authorized Officer. Slash shall be piled by an excavator equipped with a hydraulic thumb. Finished piles shall be tight and free of dirt.

a. Unmerchantable logs greater than six (6) inches on the small end shall be

left in place or positioned so that they will not be burned.

b. Slash less than six (6) inches in diameter would be less than one (1) foot in height.

c. Machine piles shall be located as far as possible from retention trees, snags, or unit boundaries to minimize damage.

d. Machine piles shall be kept free of dirt and other non-wood debris and constructed as compactly as possible. There should be an adequate supply of finer fuels located within and under the covered area of the pile to ensure ignition of the larger fuels.

e. A minimum 10-foot by 10-foot cover of four (4) mil (0.004) inch thick polyethylene shall cap each machine pile to maintain a dry ignition point. The cover shall be firmly fixed to each pile to hold it in place. Plastic shall be held in place with woody debris or tied with rope or twine. The plastic must be secured so that it is held in place during strong wind conditions. The Purchaser is required to furnish the covering materials. Covering shall be completed as directed by the Authorized Officer.

f. Cutting Areas shall be piled during the same season that they are logged.

2. Slashing shall be completed as directed by the Authorized Officer.

a. All standing woody vegetation (brush), whips, and designated trees over one (1) foot in height shall be felled (slashed) and lopped into four (4) foot or smaller lengths in harvest units as directed by the Authorized Officer. Designated trees to be slashed include red alder and big leaf maple which are not otherwise reserved in Section 41 of this contract.

b. All logging slash and slashed woody vegetation that is greater than four (4) feet in length and between one (1) inch and six (6) inches in diameter shall be lopped if not being machine piled. Larger material which has a portion meeting this specification must be bucked at the six (6) inch diameter.

c. All woody vegetation, whips, and designated trees shall be completely severed from the stump(s). Stump height shall not exceed six (6) inches measured on the uphill side.

d. All conifers, Pacific madrone, Pacific dogwood, Oregon ash, and Oregon white oak, and Pacific yew trees shall be reserved and undamaged.

3. Pile and burn landing slash within thirty (30) feet of the edge of each landing, all tops, broken pieces, limbs and debris more than one (1) inch in diameter at the large end and longer than three (3) feet in length shall be piled within fifteen (15) days of completion of hauling logs from that landing. Landing piles shall be kept free of dirt and located adjacent to roads at least twenty (20) feet from any Reserve Tree and/or as directed by the Authorized

Officer. Upon completion of landing piling, the Purchaser shall prepare the landing piles for burning by securely covering each landing pile with four (4) mil (0.004) inch thick polyethylene plastic film at least 10 feet wide. Landing piles shall be covered sufficiently to allow for ignition in wet conditions as approved by the Authorized Officer. The plastic shall be oriented southwest to northeast. Pieces of burnable material shall be placed on top of the plastic to secure it from moving and to prevent it from blowing off during strong wind episodes. The Purchaser is required to furnish the covering materials. The timing of this covering work shall be in accordance with instructions from the Authorized Officer. No landing debris shall be dozed off the landing and covered with dirt. Debris which has been buried and is determined to be the source of holdover fire shall be excavated by the Purchaser, at the Purchaser's expense, with a tractor and/or hydraulic excavator as directed by the Authorized Officer. If the structure of the landing piles will not permit adequate consumption of piled debris by burning, the Purchaser shall re-pile them at the direction of the Authorized Officer.

ii. Notwithstanding the provisions of Sec. 15 of this contract, the Government shall assume all obligations for disposal or reduction of fire hazards created by Purchaser's operations on Government lands, except for burning and mop-up assistance as required herein and measures required in Section 42(hh). The Purchaser shall, under supervision of the Authorized Officer or designated representative, assist in preparing units for burning, burning, mop-up, and patrol by furnishing, at the Purchaser's own expense, the services of personnel and equipment on each unit as shown below:

1. For Igniting, Burning, Mop-up of Piles on Units:

1. One work leader(s) Firefighter Type 1 (FFT1) qualified according to National Wildfire Coordinating Group (NWCG) Wildland Fire Qualifications System guide, PMS 310-1) to supervise crew and equipment operations, and to serve as Purchaser's representative.

2. Five-person crew Firefighter Type 2 (FFT2) qualified according to National Wildfire Coordination Group (NWCG) Wildland Fire Qualifications System guide, PMS 310-1, with sufficient fuel for burning, six (6) drip torches, one (1) power saw, and one (1) backpack pump, one (1) tool for each crew member.

3. The crew shall arrive on the project area with radios capable of inter-crew communications and communication with a BLM representative at a ratio of one (1) radio per every five (5) crewmembers.

4. All ignition and mop-up personnel will be directly supervised by a BLM representative.

Aircraft and pilots used for Logging Residue Reduction or the suppression of escaped fires from Logging Residue Reduction operations, shall be acquired from a list of aircraft and pilots approved (i.e., carded for these specific activities) by the Office of Aircraft Services or the U.S. Forest Service. This list is available from BLM District Offices upon request.

All listed personnel shall be physically fit, experienced and fully capable of functioning as required. In addition, all listed personnel shall be qualified according to the National Wildfire Coordinating Group

(NWCG) Wildland Fire Qualification System Guide, PMS-310-1 and provide documentation of these qualifications. On the day of ignition all listed personnel shall be fluent in speaking and understanding English, clothing shall consist of long pants and long sleeved shirts and be of approved aramid fabric (Nomex™ or equivalent), as well as being free of diesel fuel oil. All personnel shall wear lug sole boots with minimum eight (8) inch tall uppers that provide ankle support, approved hardhats and leather gloves. Personnel who do not meet these requirements or do not have proper clothing and personal protective equipment (PPE) will not be allowed to participate. All listed tools and equipment shall be in good usable condition. All power-driven equipment shall be fully fueled and available for immediate use. During periods of use under this subsection, the Purchaser shall provide fuel and maintenance for all such power-driven equipment.

Except as provided hereafter for fire escapement, the Purchaser shall continue the required assistance in mop up on each cutting unit shown on Exhibit A for seventy-two (72) hours, as directed by the Authorized Officer within a five (5) day period commencing at 8:00 a.m. the day following the completion of ignition in that unit, or until released from such service by the Government, whichever occurs first.

In event of a fire escapement, the Purchaser's personnel and equipment shall, under supervision of the Authorized Officer, take action to control and mop up the escaped fire until released from such service by the Government. If it becomes necessary to use furnished personnel and equipment for the suppression of a fire which escapes from the prescribed fire area for a period beyond the remainder of the day in which the fire escapes, then the Government shall, at its option: (1) reimburse the Purchaser for such additional use of personnel and equipment at wage rates shown in the current Administratively Determined Pay Rates for the Western Area and at equipment rates shown in the current Oregon-Washington Interagency Fire Fighting Equipment Rental Rates schedule until the Purchaser is released from such service by the Government; or (2) release the Purchaser from additional suppression work and assume responsibility for suppressing the escaped fire.

In situations where an escaped fire is controlled and contained by an adequate fire break (i.e., trail, road, stream, rock formation, etc.), the Government may permit the Purchaser to remove personnel for that day; provided that all mop up work on the escaped fire is included with mop up work on the prescribed fire area. In such an event, the Purchaser must sign a statement of agreement to complete mop up work on all escaped fire areas concurrently with mop up work on the prescribed fire area.

In case of injury to personnel or damage to equipment furnished as required by this subsection, liability shall be borne by the Purchaser, unless such injury or damage is caused by Government negligence.

Time is of the essence in complying with this provision. In the event the Purchaser fails to provide the personnel and equipment required herein, the Purchaser shall be responsible for all additional cost incurred by the Government in disposing of slash including but not limited to the wages and other costs of providing federal employees and others as substitute labor force, the cost of providing substitute equipment and appropriate additional overhead expenses. If the Purchaser's failure results in a deferral of burning and new conditions necessitate additional personnel and equipment to accomplish the planned burn, the Purchaser also shall be responsible for such additional costs.

CREATION OF COARSE WOODY DEBRIS

jj. In the Coarse Woody Debris Creation Units shown on Exhibit F, the Purchaser shall, upon completion of yarding, select and fall, top, high-girdle, or basal-girdle two hundred five (205) live trees in accordance with Exhibit F. No adjustments of volume or value shall be made to meet these requirements.

CONTRIBUTIONS

kk. The Purchaser shall create coarse woody debris in accordance with Section 42.jj. The Purchaser shall have the option of completing this work, or in lieu thereof, may make a buyout security deposit to the Bureau of Land Management in the amount of eighteen thousand four hundred ninety and 88/100 dollars (\$18,490.88), and upon making such deposit, the Purchaser shall be relieved of the obligations set out in this subsection. The Purchaser shall notify the Authorized Officer of their intention to make this deposit prior to the date of execution of this contract and the Authorized Officer shall establish a required schedule of payments.

LOG EXPORT RESTRICTION

ll. All timber sold to the Purchaser under the terms of the contract, except exempted species, is restricted from export under the United States in the form of unprocessed timber, and is prohibited from being used as a substitute for exported private timber. For the purpose of this contract, unprocessed timber is defined as (1) any logs except those of utility grade or below, such as saw logs, peeler logs, and pulp logs; (2) cants or squares to be subsequently remanufactured exceeding eight and three-quarters (8-3/4) inches in thickness; (3) split or round bolts or other round wood not processed to standards and specifications suitable for end-product uses; or (4) western red cedar lumber which does not meet lumber of American Lumber Standards Grades of Number 3 dimension or better, or Pacific Lumber Inspection Bureau R-List Grades of Number 3 Common or better.

Thus, timber manufactured into the following will be considered processed: (1) lumber and construction timbers, regardless of size, manufactured to standards and specifications suitable for end product uses; (2) chips, pulp and pulp products; (3) green or dry veneer and plywood; (4) poles and piling cut or treated for use as such; (5) cants, squares, and lumber cut for remanufacturing of eight and three-quarters (8-3/4) inches in thickness or less; (6) shakes and shingles. Substitution will be determined under the definition found in 43 CFR 5400.0-5(n).

The Purchaser is required to maintain and upon request to furnish the following information:

1. Date of last export sale.
2. Volume of timber contained in last export sale.
3. Volume of timber exported in the past twelve (12) months from the date of last export sale.
4. Volume of Federal timber purchased in the past twelve (12) months from date of last export sale.
5. Volume of timber exported in succeeding twelve (12) months from date of last export sale.
6. Volume of Federal timber purchased in succeeding twelve (12) months from date of last export sale.

In the event the Purchaser elects to sell any or all of the timber sold under this contract in the form of unprocessed timber, the Purchaser shall require each party buying, exchanging, or receiving such timber to execute a Form 5450-017 (Export Determination). The original of such certification shall be filed with the Authorized Officer. Additionally, when the other party is an affiliate of the Purchaser, the Purchaser will be required to update information under item (3) of Form 5450-017 (Export Determination) and file the form with the Authorized Officer.

In the event an affiliate of the Purchaser has exported private timber within twelve (12) months prior to purchasing or otherwise acquiring Federal timber sold under this contract, the Purchaser shall, upon request, obtain from the affiliate information in the form specified by the Authorized Officer and furnish the information to the Authorized Officer.

Prior to the termination of this contract, the Purchaser shall submit to the Authorized Officer Form 5460-15 (Log Scale and Disposition of Timber Removed Report), which shall be executed by the Purchaser. The purchaser shall also provide a current, interim Log Scale and Disposition of Timber Removed Report (Form 5460-15) upon request by the Authorized Officer at any time during the contract period for cutting and removal specified in Section 4 of this contract as amended. In addition, the Purchaser is required under the terms of this contract to retain for a three-year period from the date of termination of the contract the records of all sales or transfer of logs involving timber from the sale for inspection and use of the Bureau of Land Management.

Unless otherwise authorized in writing by the Contracting Officer, the Purchaser shall brand clearly and legibly one end of all logs with a scaling diameter (small end inside bark) of over ten (10) inches, prior to the removal of timber from the contract area. All loads of eleven (11) logs or more will have a minimum of ten (10) logs clearly and legibly branded on one end regardless of the diameter of the logs. All logs will be branded on loads of ten (10) logs or less. One end of all branded logs to be processed domestically will be marked with a three (3) square inch spot of highway yellow paint. The Purchaser will stop trucks for accountability monitoring at mutually agreed upon locations when notified by the Authorized Officer.

If multiple trailers (mule trains) are used, each bunked load shall be considered an individual load, and these guidelines will apply to each bunked load. If a flatbed stake trailer is used, each bundle will be treated as a separate load.

At the discretion of the Contracting Officer, the Purchaser may be required to brand and paint all logs. Any increased costs for log branding and painting shall be the responsibility of the Purchaser.

In the event of the Purchaser's noncompliance with this subsection of the contract, the Authorized Officer may take appropriate action as set forth in Section 10 of this contract. In addition, the Purchaser may be declared ineligible to receive future awards of Government timber for a period of one year.

mm. Addendum to Section 3(b) (5) Provided further; that in the case of contracts with a thirty-nine (39) month or longer term, the Purchaser shall also be required by the third anniversary date to either (i) pay no less than sixty (60) percent of the total purchase price or (ii) complete road construction required under the contract the value of which when combined with contract payments is equal to no less than sixty (60) percent of the total purchase price.



United States Department of the Interior
 BUREAU OF LAND MANAGEMENT
 TIMBER SALE CONTRACT MAP

Contract No. ORN04-TS-2023.0401
 Big Maple Timber Sale
 Exhibit A
 Page 1 of 3

9/8/2022

T. 4S. R. 7W, Section 33 W. M. - NORTHWEST OREGON DISTRICT - OREGON

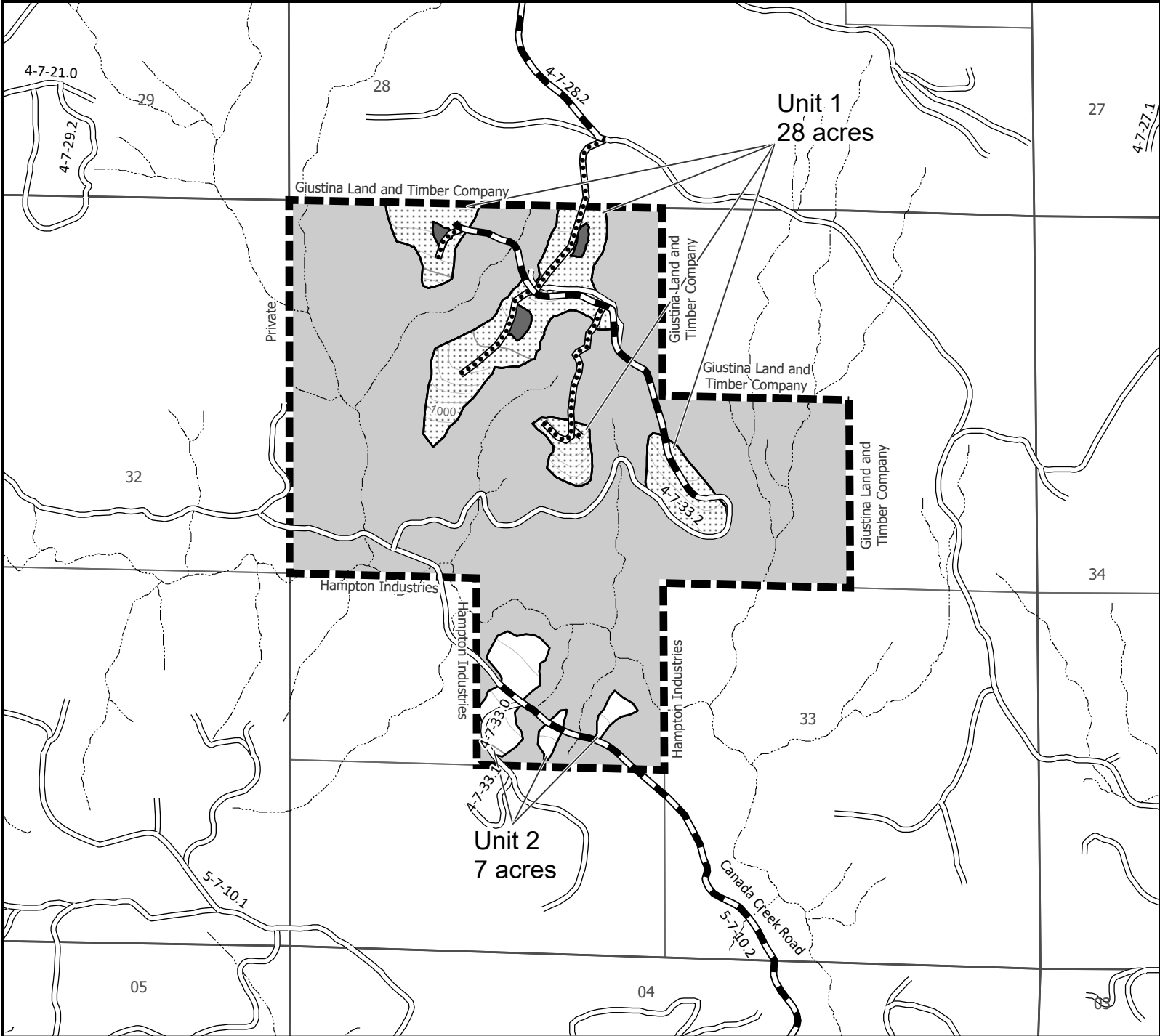

Partial Cut Area	26 acres
Regeneration Cut Area	123 acres
Right-of-Way	2 acres
Reserve Area	430 acres
Clump	8 acres
Patch Cut	2 acres
Total Contract Area	586 acres

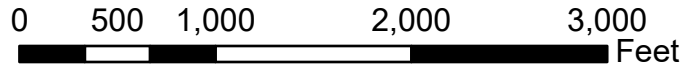

- Contract Area
- Reserve Area
- Partial Cut
- Regeneration Harvest
- Gap
- Construct
- Renovate
- Existing Road
- Streams
- Clump

Contour Interval: 40 feet

No warranty is made by the Bureau of Land Management as to the accuracy, reliability, or completeness of these data for individual or aggregate use with other data. Original data were compiled from various sources and may be updated without notification. Note: Boundaries of harvest areas are painted/flagged in orange and posted. Right-of-ways (ROW) are posted. Harvest area acres do not include existing roads. Prepared By: dtyler



United States Department of the Interior
 BUREAU OF LAND MANAGEMENT
 TIMBER SALE CONTRACT MAP

Contract No. ORN04-TS-2023.0401
 Big Maple Timber Sale
 Exhibit A
 Page 2 of 3

9/8/2022

T. 5S. R. 7W, Sections 3 & 9 W. M. - NORTHWEST OREGON DISTRICT - OREGON

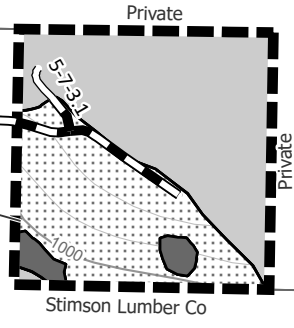
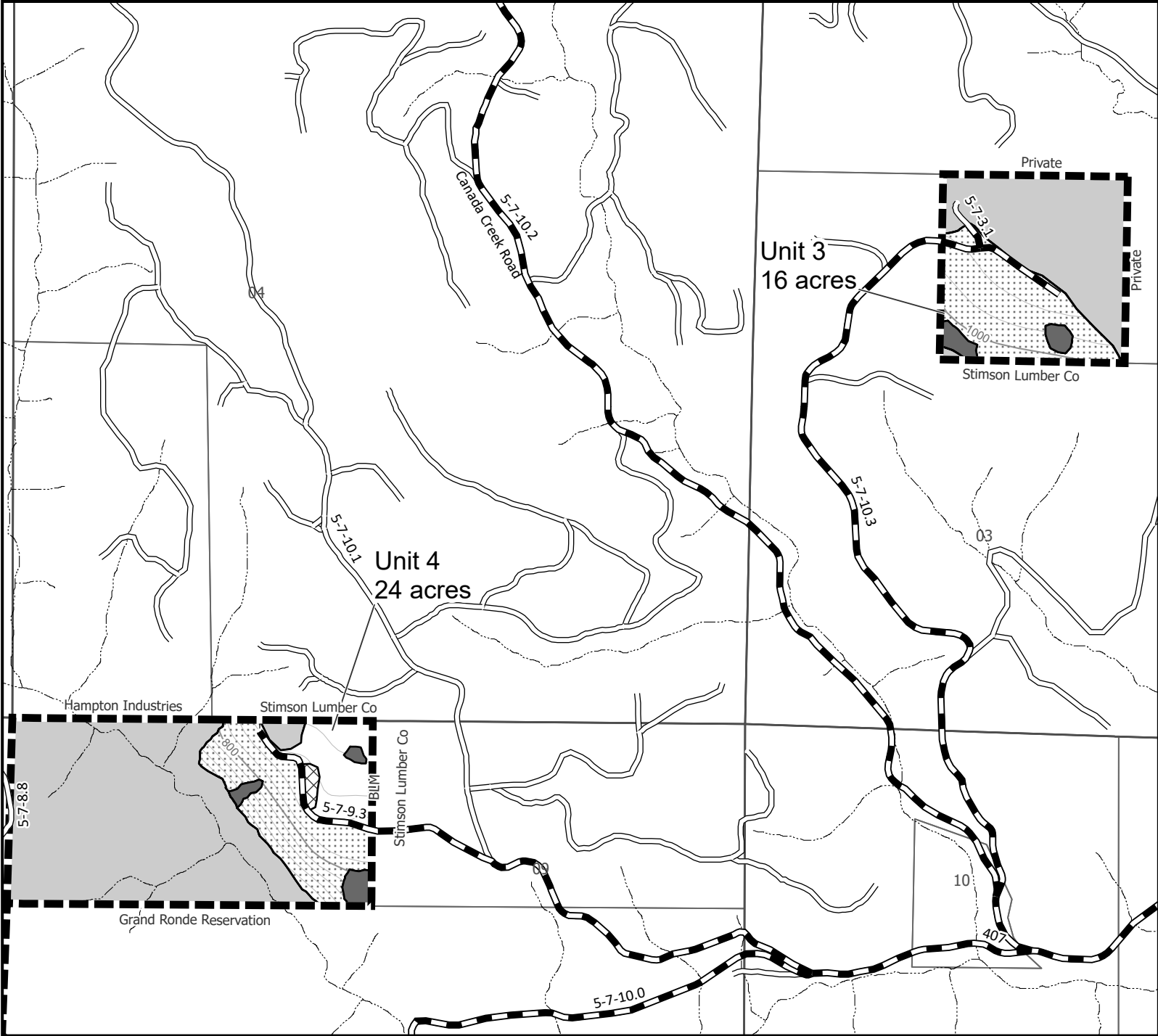

Partial Cut Area	26 acres
Regeneration Cut Area	123 acres
Right-of-Way	2 acres
Reserve Area	430 acres
Clump	8 acres
Patch Cut	2 acres
Total Contract Area	586 acres

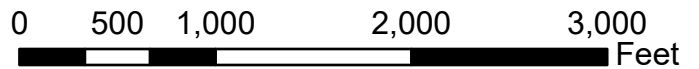

- Contract Area
- Reserve Area
- Partial Cut
- Regeneration Harvest
- Gap
- Construct
- Renovate
- Existing Road
- Streams
- Clump

Contour Interval: 40 feet

No warranty is made by the Bureau of Land Management as to the accuracy, reliability, or completeness of these data for individual or aggregate use with other data. Original data were compiled from various sources and may be updated without notification. Note: Boundaries of harvest areas are painted/flagged in orange and posted. Right-of-ways (ROW) are posted. Harvest area acres do not include existing roads. Prepared By: dtyler



United States Department of the Interior
 BUREAU OF LAND MANAGEMENT
 TIMBER SALE CONTRACT MAP

Contract No. ORN04-TS-2023.0401
 Big Maple Timber Sale
 Exhibit A
 Page 3 of 3

9/8/2022

T. 5S. R. 7W, Section 8 W. M. - NORTHWEST OREGON DISTRICT - OREGON

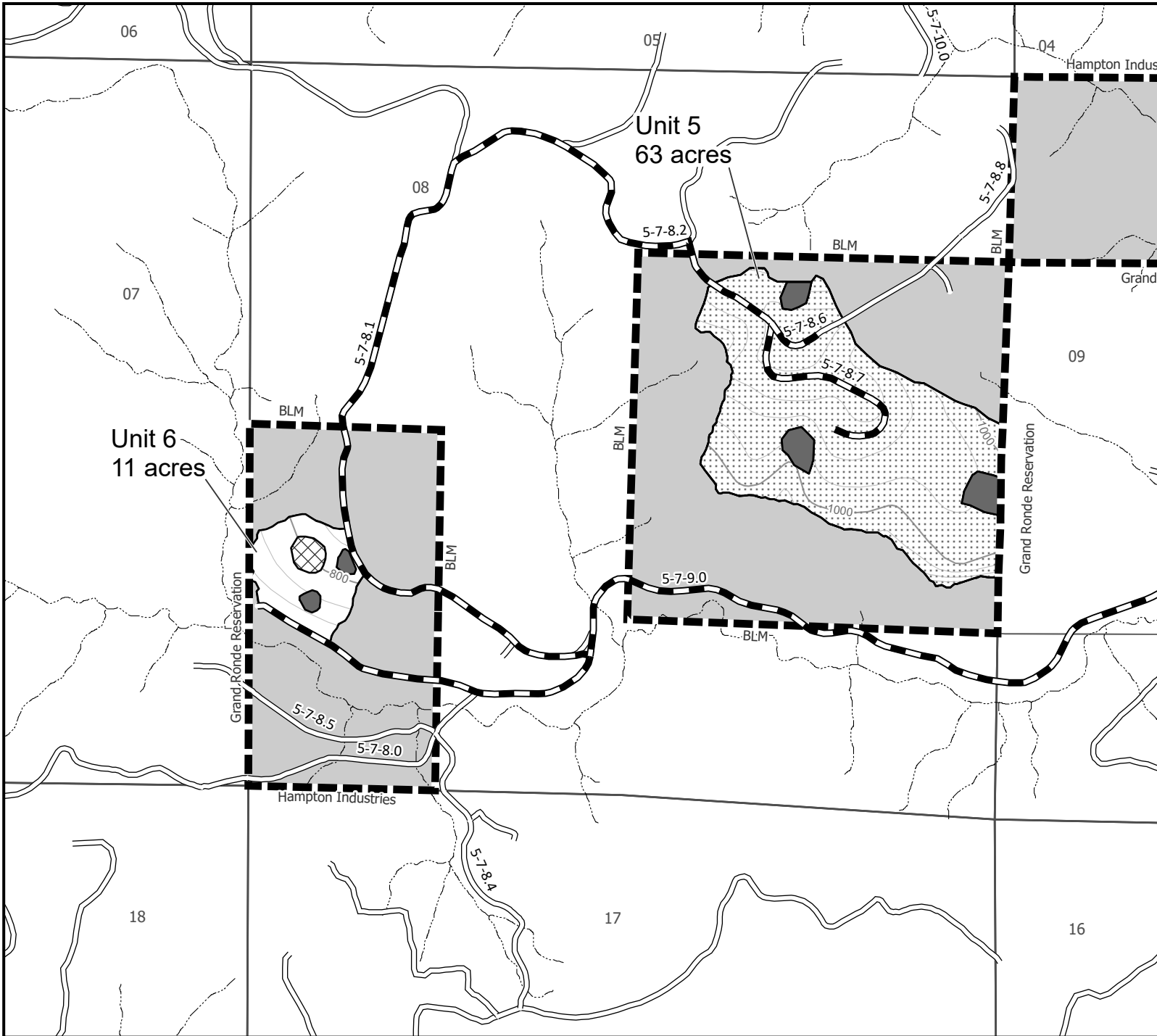

Partial Cut Area	26 acres
Regeneration Cut Area	123 acres
Right-of-Way	2 acres
Reserve Area	430 acres
Clump	8 acres
Patch Cut	2 acres
Total Contract Area	586 acres

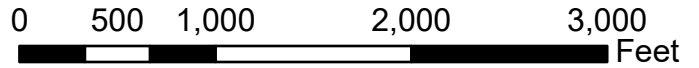

- Contract Area
- Construct
- Renovate
- Reserve Area
- Partial Cut
- Regeneration Harvest
- Clump
- Existing Road
- Streams
- Gap

Contour Interval: 40 feet

No warranty is made by the Bureau of Land Management as to the accuracy, reliability, or completeness of these data for individual or aggregate use with other data. Original data were compiled from various sources and may be updated without notification. Note: Boundaries of harvest areas are painted/flagged in orange and posted. Right-of-ways (ROW) are posted. Harvest area acres do not include existing roads. Prepared By: dtyler

UNITED STATES
DEPARTMENT OF THE INTERIOR
BUREAU OF LAND MANAGEMENT

Contract No.
ORN04-TS-2023.0401
Big Maple

EXHIBIT B / PRE-SALE

5450-3

The following estimates and calculations of value of timber sold are made solely as an administrative aid for determining: (1) adjustments made or credits given in accordance with Secs. 6, 9, or 11; (2) when payments are due; and (3) value of timber subject to any special bonding provisions. The value of timber will be determined by multiplying the value per acre as shown below, times the amount of acreage as determined by the Authorized Officer, which has been cut or removed or designated for taking. Except as provided in Sec. 2, Purchaser shall be liable for total purchase price even though quantity of timber actually cut or removed or designated for taking is less than the estimated volume or quantity shown. Cutting areas are shown on **Exhibit A**.

SPECIES	ESTIMATED VOLUME OR QUANTITY <i>(Units Specified)</i>		PRICE PER UNIT	ESTIMATED VOLUME OR QUANTITY X UNIT PRICE
Douglas Fir	6,643.0	MBF	\$307.50	\$2,042,722.50
Bigleaf Maple	3.0	MBF	\$29.40	\$88.20
TOTALS	6,646.0	MBF		\$2,042,810.70

The apportionment of the total purchase price is as follows:

Unit 1

Douglas Fir	1,469.0 MBF	X	\$307.50	=	\$451,717.50
Total	1469.0 Mbf				\$451,717.50 ÷ 28.0 acres = \$16,132.77/Acre

Unit 2

Douglas Fir	72.0 MBF	X	\$307.50	=	\$22,140.00
Bigleaf Maple	1.0 MBF	X	\$29.40	=	\$29.40
Total	73.0 Mbf				\$22,169.40 ÷ 7.0 acres = \$3,167.06/Acre

Unit 3

Douglas Fir	816.0 MBF	X	\$307.50	=	\$250,920.00
Total	816.0 Mbf				\$250,920.00 ÷ 16.0 acres = \$15,682.50/Acre

Unit 4

Douglas Fir	844.0 MBF	X	\$307.50	=	\$259,530.00
Bigleaf Maple	1.0 MBF	X	\$29.40	=	\$29.40
Total	845.0 Mbf				\$259,559.40 ÷ 24.0 acres = \$10,814.98/Acre

Unit 5

Douglas Fir	3,264.0 MBF	X	\$307.50	=	\$1,003,680.00
Total	3264.0 Mbf				\$1,003,680.00 ÷ 63.0 acres = \$15,931.43/Acre

Unit 6

Douglas Fir	103.0 MBF	X	\$307.50	=	\$31,672.50
Bigleaf Maple	1.0 MBF	X	\$29.40	=	\$29.40
Total	104.0 Mbf				\$31,701.90 ÷ 11.0 acres = \$2,881.99/Acre

Unit R/W

Douglas Fir	75.0 MBF	X	\$307.50	=	\$23,062.50
Total	75.0 Mbf				\$23,062.50 ÷ 2.0 acres = \$11,531.25/Acre

TABLE OF CONTENTS

SECTION	PAGE	DESCRIPTION
	1-2	Road Specifications Table of Contents
100	3-9	General
150	10-12	Road Plan and Detail Sheets
200	13-14	Clearing and Grubbing
300	14-17	Excavation and Embankment
400	17-20	Pipe Culverts
500	20-21	Renovation and Improvement of Existing Roads
600	21-22	Watering
700	22-23	Aggregate Base Course – Pitrun Rock
1000	23-25	Aggregate Base Course - Crushed Rock
1200	25-27	Aggregate Surface Course - Crushed Rock
1400	27-29	Slope Protection
1700	29-30	Erosion Control
1800	30-32	Soil Stabilization
2100	32-33	Roadside Brushing
2700	33	Barricades and Control Devices
	34-35	Road Plan Maps
	36	Earth Barricade, Waterdip, Drivable and Non-Drivable Waterbar Details
	37	Brushing Details
	38	Sediment Catch Basin Details
	39-43	Culvert List
	44	Culvert Installation Details
	45	Culvert Band Details
	46-49	Rock Volumes Totals

**U.S. DEPARTMENT OF THE INTERIOR
 Bureau of Land Management
 SALEM DISTRICT – OREGON
 TIMBER SALE CONTRACT
 ROAD SPECIFICATIONS**

Road Number And Segment	New Construction (Stations and Miles)	Improvement (Stations and Miles)	Renovation (Stations and Miles)
4-7-21.0			43+98 Sta. = 0.833 Miles
4-7-28.2			40+87 Sta. = 0.774 Miles
4-7-28.3	21+08 Sta. = 0.399 Miles		
4-7-28.3a	1+15 Sta. = 0.022 Miles		
4-7-28.3b	1+61 Sta. = 0.030 Miles		
4-7-33.2			29+35 Sta. = 0.556 Miles
4-7-33.5	12+12 Sta. = 0.300 Miles		
4-7-33.6	0+98 Sta. = 0.019 Miles		
4-7-33.7	2+68 Sta. = 0.051 Miles		
5-7-3.1			1+20 Sta. = 0.023 Miles
5-7-8.1			47+57 Sta. = 0.901 Miles
5-7-8.2			19+43 Sta. = 0.368 Miles
5-7-8.6			12+03 Sta. = 0.228 Miles
5-7-8.7			17+23 Sta. = 0.326 Miles
5-7-9.0			98+79 Sta. = 1.871 Miles
5-7-9.3			21+23 Sta. = 0.402 Miles
5-7-10.0			27+83 Sta. = 0.527 Miles
5-7-10.1			25+82 Sta. = 0.489 Miles
5-7-10.2			114+34 Sta. = 2.166 Miles
5-7-10.3			66+84 Sta. = 1.266 Miles
Coast Creek County Rd			63+31 Sta. = 1.199 Miles

GENERAL – 100

101 - Pre-work Conference(s):

A pre-work conference will be held prior to the start of new construction, renovation, improvement, quarry development, and decommissioning operations. The Purchaser shall request the conference at least forty-eight (48) hours prior to the time it is to be held. The conference will be attended by the Purchaser and/or their representatives, subcontractors or their representatives and the Authorized Officer and/or their representatives.

The purpose of the prework conference will be to review the required work, exhibits and specifications, and to establish a work schedule and a list of the Purchaser's representatives and subcontractors.

102 - Definitions:

AASHTO - American Association of State Highway and Transportation Officials. Current editions of tests and specifications.

Apparent Opening Size (AOS) - Number of the U.S. Bureau of Standard sieve (or its opening size in millimeters or inches) having openings closest in size to the diameter of uniform particles which will allow five (5) percent by weight to pass through the geotextile material when shaken in a prescribed manner. This is also referred to as Equivalent Opening Size (EOS).

ASTM - American Society for Testing and Materials.

Base Course - Surfacing structure consisting of crushed gravel or stone, crushed sandstone, pit-run rock, bank or river-run gravels, etc., to provide support and, in the event no surface course is placed, the running surface for traffic load.

BLM - Bureau of Land Management

Borrow - Excavated material required for embankments and other portions of the work.

Burst Strength - The resistance of a geotextile material to rupture from pressure applied at right angles to the plane of the geotextile material under specified conditions, usually expressed as the amount of pressure causing failure. Rupture or burst results from tensile failure of the geotextile material.

Culvert - A pipe, pipe-arch, arch, or box structure constructed of metal, concrete, plastic or wood which provides an opening under the roadway primarily for the conveyance of liquids, pedestrians or livestock.

Curve Widening - Widening required on inside of curves to accommodate long log and equipment hauling trucks.

Embankment - A structure of soil, aggregate, or rock material placed on a prepared ground surface and constructed to subgrade.

End Haul - Excavated material moved, other than by dozer, to an embankment or waste area to prevent sidecasting material outside of the road prism.

Excess Excavation - Material from the roadway in excess of that needed for construction of the designed roadway (waste).

Grab Tensile Strength - A modified tensile strength of a geotextile material. The strength of a specific width of geotextile material together with the additional strength contributed by adjacent areas. Typically, grab strength is determined on a 12-inch-wide strip of geotextile material, with the tensile load applied at the midpoint of the geotextile material width through 1-inch-wide jaw faces.

Grading - Leveling to grade, shaping and smoothing of a road subgrade; the shaping of roadside ditches as to grade and contour. In some instances includes smoothing of the cut bank.

Nonwoven Geotextile Material - A textile structure produced by bonding or interlocking of fibers, or both, accomplished by mechanical or chemical means.

Overhaul - Distance excavated material is transported in excess of the distance included in the cost for excavation.

Penetration Resistance - The geotextile material property determined by the force required to penetrate a geotextile material with a sharp pointed object. Initial penetration is by separating the fibers. Further penetration is essentially a tearing process.

Percent Open Area - The net area of a geotextile material that is not occupied by geotextile material filaments, normally determinable only for woven and nonwoven geotextile material having distinct, visible, and measurable openings that continue directly through the geotextile material.

Permeability - The geotextile material property which permits water to be transmitted in the longitudinal or transverse planes of the geotextile material.

Pioneer Road - Temporary construction access built along the route of the project.

Piping - The process by which soil particles are washed in or through pore spaces in drains and filters or poorly compacted fill/backfill material.

Plans - The approved drawings, or exact reproductions thereof which show the locations, character, dimensions, and details of the work to be done.

Pore Size - The size of an opening between geotextile material filaments; apparent opening size (AOS) is used to quantify this geotextile material property.

Puncture Resistance - The geotextile material property determined by the force required to penetrate a geotextile material with a blunt object. Failure results in a tearing of the geotextile material.

Purchaser - The individual, partnership, joint venture, or corporation contracting with the Government under the terms of a Timber Sale Contract and acting independently or through their, or its agents, employees, or contractors.

Reasonably Close Conformity - Compliance with reasonable and customary manufacturing and construction tolerances where working tolerances are not specified.

Reinforcement - Strengthening of concrete with iron bars or mesh: geotextile with geotextile material inclusion: subgrade with aggregate: etc.

Roadbed - The graded portion of the road within top and side slopes, prepared as a foundation for the pavement structure and shoulders.

Road Centerline - The longitudinal center of a roadbed.

Road Improvement - Work done to an existing road which improves it over its original design standard.

Road Renovation - Work done to an existing road which restores it to its original design.

Roadway - The portion of a road within limits of construction. Usually from the toe of the fill slope to a point where the cut slope intersects natural ground line.
Synonym - road prism.

Scale - In quarrying, consists of the removal of loose or overhanging rock adhering to the solid face after a shot or a round of shots has been fired.

Scarification - The process of loosening or breaking up of the surface layer of soil or road, usually to a specified depth.

Separation - Function of geotextile material as a partition between adjacent materials to prevent mixing of those materials.

Shoulder - The portion of the roadbed contiguous with the traveled way designed for accommodation of stopped vehicles, safety, and lateral support of base and surface courses.

Slope ratio notation (horizontal:vertical) - Slope ratios for constructed cut and fill slopes are expressed as a ratio of horizontal units to vertical units.

Spalls - Flakes or chips of stone.

Specifications - A general term applied to all directions, provisions, and requirements pertaining to performance of the work.

Specific Gravity - The ratio of the density of a material to the density of water obtained by weighing known volumes of both items in air. A specific gravity less than one implies that the material will float.

Structures - Bridges, culverts, catch basins, retaining walls, underdrains, flumes, splash pads, downspouts, and other project features which may be involved in the work and not otherwise classified in these specifications.

Sub-base - Reinforcement of the subgrade with large particles of pit-run rock or crushed stone. Usually confined to roads having wet subgrades or subgrades with weak support characteristics.

Surface Course - Top layer of a road structure consisting of finely crushed gravels or asphalt designed to provide a smooth running surface for traffic load.

Subgrade - The top surface of a roadbed upon which the traveled way and shoulders are constructed.

Tensile Strength - The strength shown by a geotextile material subjected to tension as distinct from torsion, compression, or shear.

Tensile Stress - Strain Modulus - A measure of the resistance to elongation under stress. The ratio of the change in tensile stress to the corresponding change in strain.

Tensile Test - A test which subjects geotextile material to tensile forces and measures resultant stresses and strains.

Timber - Standing trees, downed trees, or logs which can be measured in board feet.

Traveled Way - The portion of the roadbed used for the movement of vehicles, exclusive of shoulders.

Typical Cross Sections - Cross-sectional plane of a typical roadway; showing natural ground line and designed roadway in relation to cut and fill, through cut, and through fill.

Turnout - Extra widening of the roadbed at appropriate intervals on single-lane roads for passing purposes.

Ultraviolet (UV) Radiation Stability - The ability of geotextile material to resist deterioration from exposure to sunlight.

102a - Tests Used in These Specifications:

<u>AASHTO T 11</u>	Quantity of rock finer than No. 200 sieve.
<u>AASHTO T 27</u>	Sieve analysis of fine and coarse aggregate using sieves with square openings; gradation.
<u>AASHTO T 89</u>	Liquid limit of material passing the No. 40 sieve. Water content at which the soil passes from a plastic to a liquid state.
<u>AASHTO T 90</u>	Plastic limits and plasticity index of soil. a. Plastic limit - lowest water content at which the soil remains plastic. b. Plasticity index - range of water content, within which the material is in a plastic state. Numerical difference between the liquid and plastic limits of the soil.
<u>AASHTO T 96</u>	Resistance to abrasion of small size coarse aggregate by use of the Los Angeles machine.
<u>AASHTO T 99</u>	Relationship between soil moisture and density of soil. Method A - 4" mold, soil passing a No. 4 sieve 25 blows/layer & 3 layers. Method C - 4" mold, soil passing a 3/4 inch sieve 25 blows/layer & 3 layers. Method D - 6" mold, soil passing a 3/4 inch sieve. 56 blows/layer & 3 layers.
<u>AASHTO T 166</u>	Specific Gravity of compacted Bituminous Mixtures.
<u>AASHTO T 176</u>	Shows relative portions of fine dust or claylike materials in soil or graded aggregate.
<u>AASHTO T 180</u>	(OSHD 106-71) moisture density relationship of soil same as AASHTO T 99 proctor but uses a 10-lb rammer & 18-in drop height.
<u>AASHTO T 191</u>	<u>Sand Cone.</u> Density of soil in place: For subgrade use 6-inch or 12-inch cone. For rock surfacing for 1-1/2-inch minus to 3-inch minus use 12-inch cone.
<u>AASHTO T 205</u>	<u>Rubber balloon.</u> Density of soil in place. Use for compacted or firmly bonded soil.
<u>AASHTO T 209</u>	Maximum Specific Gravity of Bituminous Paving Mixtures.

AASHTO T 210 Durability of aggregates based on resistance to produce fines.

AASHTO T 224 Correction for coarse particles in the soil.

AASHTO T 238 Density of Soil and Soil-Aggregate in place by nuclear methods.

AASHTO T 248 Reducing field samples of aggregate to testing size by mechanical splitter, quartering, or miniature stockpile sampling.

ASTM D 4564 Determination of relative density of cohesion less soils.

DMSO (dimethyl sulfide) Determines volume of expanding clays in aggregates. Usually associated with marine basalts.

103 - Compaction equipment shall meet the following requirements:

103b - Sheepsfoot/Tamping rollers. A tamping roller unit shall consist of two (2) watertight metal drums mounted in frames in such manner as to be fully oscillating, together with a tractor having sufficient weight and power under actual working conditions to pull the roller drums at a minimum speed of two and a half (2.5) miles per hour. The drums shall be no less than sixty (60) inches in diameter and no less than fifty-four (54) inches in length, measured at the drum's surface, and shall be studded with tamping feet projecting not less than seven (7) inches from the face of the drums.

The distance between circumferential rows of tamper feet shall be such that the diagonal distance from any foot to the nearest foot in each adjacent row shall be not more than twelve (12) inches. The cross-sectional area of the face of each tamper foot, measured perpendicular to the axis of the stud, shall be not less than 5-1/2 square inches nor more than eight (8) square inches.

The weight of the tamping-roller unit shall be such as to exert a minimum pressure of two hundred fifty (250) pounds per square inch on the ground area in contact with the tamping feet, and the roller shall be so designed that the weight may be increased to exert a pressure up to five hundred (500) pounds per square inch on the ground area in contact with the tamping feet.

The ground pressure shall be determined by dividing the total weight of the roller unit, not including the weight of the tractor, by the total cross-sectional area of the tamping feet in one (1) row of tamping feet parallel to the axis of the roller.

103f - Vibratory roller. The drum diameter shall be not less than forty-eight (48) inches, the drum width not less than fifty-eight (58) inches, and have a turning radius of fifteen (15) feet or less. Vibration frequency shall be regulated in steps to 1400,

1500, and 1600 vibrations per minute (VPM), corresponding to engine speeds of 1575, 1690, and 1800 RPM. The centrifugal force developed shall be seven (7) tons at 1600 RPM. It shall be activated by a power unit of not less than twenty-five (25) horsepower. The vibratory roller shall be self-propelled or drawn by a vehicle of sufficient horsepower to enable the unit to travel through a loose layer of material at a speed ranging from 0.9 mile to 1.8 miles per hour, as directed by the Authorized Officer.

The towing vehicle and roller or self-propelled unit meeting the above requirements shall be considered a vibratory roller unit.

- 103g - Vibratory compactor. Vibratory compactors shall consist of multiple or gang-type compacting units or pads with a minimum variable width of two (2) feet. It shall be self-contained and capable of compacting material as required.
- 103h - Drum drive self-propelled vibratory grid roller. The unit shall consist of one cylindrical drum with a drum diameter of not less than fifty-six (56) inches, nor shall be more than sixty-six (66) inches and the drum width be eighty-four (84) inches. Vibratory frequency shall be regulated in seeps from 1200 to 1800 vibrations per minute (VPM), and the centrifugal force developed shall be at least 40,000 pounds at 1800 RPM. The vibratory grid roller shall be self-propelled and have a power unit of not less than 112 horsepower. The "grid" design shall be a herringbone or z-bar pattern around the circumference of the drum. The grid bars shall be one (1) inch in height and spaced not more than eight and one half (8-1/2) inches apart.
- 103i - Other. Compaction equipment approved by the Authorized Officer.

Road Number	Start Station or Milepost	End Station or Milepost	Total Length	Typical Cross Section	Min. Curve Radius	ROAD WIDTH		GRADIENT		SURFACING (*5)										Remarks
						Subgrade	Ditch	Max. Favorable	Max. Adverse	BASE COURSE					SURFACE COURSE					
										Min. Width	Comp. Depth	Surface Type (*3)	Grading Size (*3)	Number of Lifts	Min. Width	Comp. Depth	Surface Type (*3)	Grading Size (*3)	Number of Lifts	
4-7-21.0	0.000	0.833	0.833	6		16'	2'	--	--	--	--	ABC	D	--	--	--	ASC	C	--	Renovation. Existing rock road. Re-establish ditchline and haul material to WA as directed. Spread 150 CY 1-1/2"-0" Crushed Spot Rock as marked and needed (110 CY as marked and 40 CY as needed). Spread 20 CY 6" Jaw Run Base Rock as marked. Place 20 CY 1-1/2"-0" Crushed Bedding/Backfill Rock as marked. Construct 2 Sediment Catch Basins w/ straw bales as marked. Construct turnouts and waste areas as marked or directed. Construct ditchouts as marked and needed. Install 2 cross-drains as marked. Install 2 downspouts as marked. Install 5 metal culvert inlet markers.
4-7-28.2	0.000	0.774	0.774	6		14'	2'	--	--	--	--	ABC	D	--	--	--	ASC	C	--	Renovation. Existing rock road. Re-establish ditchline and haul material to WA as directed. Spread 50 CY 1-1/2"-0" Crushed Spot Rock as needed. Place 10 CY Class 3 RipRap as outlet energy dissipater as marked. Construct 3 Sediment Catch Basins w/ straw bales as marked. Place two straw bales at existing sediment basins as marked. Construct turnouts and waste areas as marked or directed. Construct ditchouts as marked and needed. Install 6 metal culvert inlet markers.
4-7-28.3	0+00	21+08	21+08	5		14'	2'	16%	16%	--	--	ABC	D	--	--	--	ASC	C	--	New Construct. Spread 50 CY 1-1/2"-0" Crushed Spot Cap Rock as marked. Spread 80 CY 6" Jaw Run Spot Base Rock as marked. Place 55 CY 1-1/2"-0" Crushed Bedding/Backfill Rock as marked. Construct turnouts, turnarounds, junctions, and ditchouts as marked and needed. Construct a landing (approx. 50' diameter) as marked. Install 2 cross-drains. Install 2 metal inlet markers.
4-7-28.3a	0+00	1+15	1+15	5		14'	2'	16%	16%	--	--	--	--	--	--	--	--	--	--	New Construct. Construct junctions, and ditchouts as marked and needed. Tie ditchline into ditchline of 4-7-33.2.
4-7-28.3b	0+00	1+61	1+61	5		14'	2'	16%	16%	--	--	--	--	--	--	--	--	--	--	New Construct. Construct junctions, and ditchouts as marked and needed. Tie ditchline into ditchlines of 4-7-28.3 and 4-7-33.2.
4-7-33.2	0+00	1+06	1+06	3		14'	0'	--	--	--	--	--	--	--	--	--	--	--	--	Renovation. Existing natural surfaced road. Construct a landing (approx. 50' diameter) as marked.
	1+06	18+36	17+30	5		14'	2'	--	--	--	--	ABC	D	--	--	--	ASC	C	--	Renovation. Existing natural surfaced road. Re-establish ditchline and haul material to WA as directed. Spread 85 CY 1-1/2"-0" Crushed Spot Rock as marked. Spread 110 CY 6" Jaw-Run Spot Base Rock as marked. Place 115 CY 1-1/2"-0" Crushed Culvert Bedding/Backfill Rock as marked. Construct turnouts, turnarounds, and waste areas as marked or directed. Construct ditchouts and lead-off ditches as marked and needed. Install 6 cross-drains as marked. Install 1 stream culvert (medium fill depth) as marked. Install 7 metal culvert inlet markers.
	18+36	21+75	3+39	3		14'	0'	--	--	--	--	--	--	--	--	--	--	--	--	Renovation. Existing natural surfaced road. Use excavated material as fill to transition road through junction of 4-7-28.3 as directed.
	21+75	29+35	7+60	5		14'	2'	--	--	--	--	ABC	D	--	--	--	ASC	C	--	Renovation. Existing natural surfaced road. Re-establish ditchline and haul material to WA as directed. Spread 50 CY 1-1/2"-0" Crushed Spot Rock as marked. Spread 65 CY 6" Jaw-Run Spot Base Rock as marked. Place 60 CY 1-1/2"-0" Crushed Culvert Bedding/Backfill Rock as marked. Place 25 CY Class 5 RipRap as outlet fill armor/stabilization wall as marked. Place 5 CY Class 5 RipRap as inlet fill armor as marked. Construct 2 Sediment Catch Basins w/ straw bales as marked. Construct turnouts, turnout, junction, and waste areas as marked or directed. Construct a landing (approx. 50' diameter) as marked. Construct ditchouts and lead-off ditches as marked and needed. Remove existing stream culvert @ Sta. 24+06 and install new CMP as marked. Backfill trench with suitable material and surface with Base and Cap Spot Rock from new installation. Install 2 cross-drains as marked. Install 1 stream culvert (medium fill depth) as marked. Install 3 metal culvert inlet markers.
4-7-33.5	0+00	6+42	6+42	5		14'	2'	18%	18%	--	--	--	--	--	--	--	--	--	--	New Construct. Construct turnouts, Waste area, junction, and ditchouts as marked and needed.
	6+42	12+12	5+70	3		14'	0'	18%	18%	--	--	--	--	--	--	--	--	--	--	New Construct. Construct junction, and ditchouts as marked and needed. Construct a landing (approx. 50' diameter) as marked.
4-7-33.6	0+00	0+98	0+98	3		14'	0'	10%	10%	--	--	--	--	--	--	--	--	--	--	New Construct. Construct junction, and ditchouts as marked and needed. Construct a landing (approx. 50' diameter) as marked.

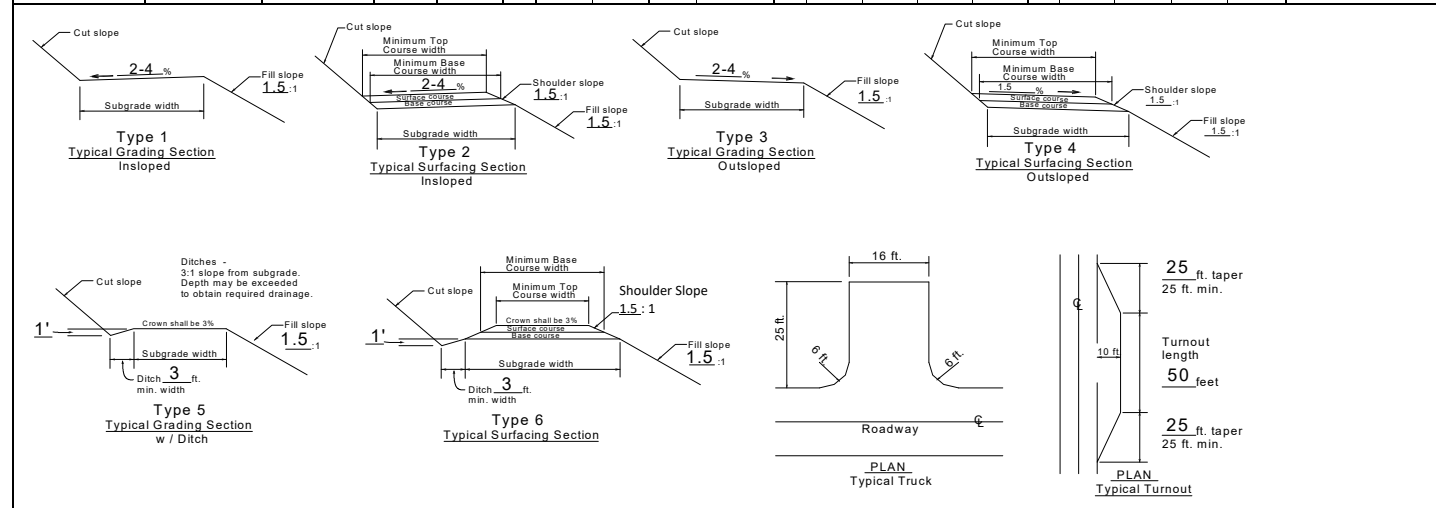

- *NOTES**
- Extra subgrade widths**
Add to each shoulder: 1 ft. for fills of 1-6 ft. and 2 ft. for fills over 6 ft. Widen the inside shoulder of curves as follows:
(See Road Plan Map, Exhibit C)
 - Backslopes**

Materials	Cut slopes	Fill slopes
Solid rock	1:4:1	Angle of repose
Soft rock and shale	1:2:1	
Common		
Slopes under 55%	1:1	1-1/2:1
Slopes over 55%	3/4:1	1-1/2:1

Note: Full bench construction is required on side slopes exceeding 60%.
 - Surface type**

Surface Type	Grading
PRR - Pit run rock	A - 3"
GRR - Grid rolled rock	B - 2"
SRN - Screened rock	C - 3" jaw run
JRR - Jaw run rock	D - 6" jaw run
ABC - Aggr. base course	E - 1 1/2" - 0"
ASC - Aggr. surface course	D - 1"
WC - Wood chips	E - 3/4"
 - Turnouts**
Width - 10 ft. in addition to subgrade width, or as shown on the plans. Located approximately as shown on the plans. Intervisible and not more than 750 ft. apart.
 - Surfacing**
Turnouts, curve widening and road approach aprons shall be surfaced.
 - Clearing width** 200
See Section
 - As posted and painted for Right-of-Way:
 - Drainage**
See Culvert List
 - Compaction** 300 and 400
See Sections
- *Clearing Limits as posted on ground**

CLEARING AND GRUBBING - 200

- 201 - This work shall consist of clearing, grubbing, removing and disposing of vegetation, debris, surface objects, and protruding obstructions within the clearing limits in accordance with these specifications and conforming to the lines, grades, dimensions and typical cross sections shown on the plans and as marked on the ground.
- 202 - Where clearing limits have not been staked, established by these specifications or shown on the plans, the limits shall extend ten (10) feet back of the top of the cut slope and five (5) feet out from the toe of the fill slope.
- 202b - Where clearing limits for channel changes and waste areas have not been staked or shown on the plans, the limits shall extend ten (10) feet back of the top of the cut slope and five (5) feet outside of the outside slope lines.
- 203 - Clearing shall consist of the removal and disposal of trees, logs, rotten material, brush, and other vegetative materials and surface objects in accordance with these specifications and within the limits established for clearing as specified under Subsections 202 and 202b, as shown on the plans, and as marked on the ground.
- 203b - Standing trees and snags to be cleared shall be felled within the limits established for clearing, unless otherwise authorized. Felled snags shall be left as down woody debris outside of the clearing limits.
- 203c - Disposal of logs from private timber cleared within the limits established shall consist of decking at a location designated by the Authorized Officer.
- 204 - Grubbing shall consist of the removal and disposal of stumps, roots, and other wood material embedded in the ground and protruding obstacles remaining as a result of the clearing operation. Undisturbed stumps, roots and other solid objects which will be a minimum of four (4) feet below subgrades or slope surfaces or embankments are excluded.
- 205 - Clearing and grubbing debris shall not be placed or permitted to remain in or under road embankment sections.
- 206a - Notwithstanding Subsections 204 and 205, clearing and grubbing debris resulting from landing construction, waste area construction, turnaround construction, or log fill replacement shall be placed at disposal sites and shall not be covered with excavated material. Location of disposal sites will be determined by the Authorized Officer.
- 210 - Disposal of clearing and grubbing debris, stumps and cull logs shall be by scattering over government owned lands outside of established clearing limits in a

manner acceptable to the Authorized Officer. The areas for such scattering shall have the prior approval of the Authorized Officer.

- 210a - Disposal of clearing and grubbing debris, stumps, and cull logs on non-government property shall be by scattering over non-government owned lands outside of established clearing limits in a manner acceptable to the Authorized Officer.
- 213 - No clearing or grubbing debris shall be left lodged against standing trees.

EXCAVATION AND EMBANKMENT - 300

- 301 - This work shall consist of excavating, overhaul, placement of embankments, backfilling, borrowing, leveling, ditching, grading, outsloping, crowning and scarification of the subgrade, compaction, disposal of excess and unsuitable and slide materials, and other earth-moving work in accordance with these specifications and conforming to the lines, grades, dimensions, and typical cross sections shown on the plans.
- 302 - Excavation shall also consist of the excavation of road and landing cut sections, borrow sites, backfilling, leveling, ditching, grading, compaction, and other earth moving work necessary for the construction of the roadway in accordance with these specifications and conforming to the lines, grades, dimensions, and typical cross sections shown on the plans and as marked on the ground.
- 303 - Suitable material removed from the excavation shall be used in the formation of embankment subgrade, shoulders, slopes, bedding, backfill for structures, and for other purposes as shown on the plans.
- 304 - Borrow shall consist of suitable material required for the construction of embankments or for other portions of the work; such material shall be obtained from sources selected by the Purchaser at his option and approved by the Authorized Officer.
- 305 - Embankment construction shall consist of the placement of excavated and borrowed materials, backfilling, leveling, grading, compaction, and other earth-moving work necessary for the construction of the roadway and landings in accordance with these specifications and conforming to the lines, grades, dimensions, and typical cross sections shown on the plans and as marked on the ground.

- 305a - Material used in the construction of embankment sections shall be free of stumps, cull logs, brush, muck, sod, roots, frozen material, and other deleterious materials and shall be placed and compacted as specified.
- 305b - Embankment materials shall be placed in successive parallel layers on areas cleared of stumps, cull logs, brush, sod, and other vegetative and deleterious materials, except as provided under Subsection 204. Roadway embankments of earth material shall be placed in horizontal layers not exceeding eight (8) inches in depth.
- 305d - Where embankments are constructed predominantly of blasted rock material, depth of layers shall not exceed (4) feet. Rock fragments having dimensions greater than 4 feet will be permitted provided that they have no dimensions greater than (6) feet and that clearance between adjacent fragments is adequate for the placing and compacting of material in horizontal layers as specified, and that no part of the larger fragments comes within (4) feet of subgrade.
- 306 - Layers of embankment and selected borrow, as specified under Subsections 305a, 305b, and 317 shall be moistened or dried to a uniform optimum moisture content suitable for maximum density and compacted to full width with compacting equipment conforming to requirements of Subsections 103b, 103g, or 103i. Final Subgrades shall be moistened or dried to a uniform optimum moisture content suitable for maximum density and compacted to full width with compacting equipment conforming to requirements of Subsections 103f or 103i.
- 306c - Compacted materials shall have a uniform density of not less than eighty-five (85) percent of the maximum density as determined by AASHTO T 99, Method A or Method D.
- 313 - In cut areas where solid rock is encountered at, or near subgrade, the rock shall be excavated to a minimum depth of six (6) inches below subgrade elevation and the excavated area backfilled with suitable material. The backfill material shall be processed to the optimum moisture content suitable for maximum density and compacted to full width in accordance with the requirements of Subsection 306.
- 314 - When heavy clays, muck, clay shale, or other deleterious material for forming the roadbed is encountered in cuts at subgrade, it shall be excavated to a minimum depth of two (2) feet below the subgrade elevation and the excavated area backfilled with a selected borrow material approved by the Authorized Officer. The backfill material shall be uniformly moistened or dried to the optimum moisture content suitable for maximum density in accordance with the

requirements of Subsection 306. Unsuitable material shall be disposed of as directed by the Authorized Officer.

- 315 - Borrow material required for the construction of embankment or for other portions of the work shall be obtained from sources adjacent to the roadway.
- 316 - Borrow material from sources selected at the Purchaser's option shall be inspected and approved in writing by the Authorized Officer prior to placement.
- 317 - Selected borrow shall consist of talus material, finely broken rock, gravel, or other material of granular or favorable characteristics from sources shown on the plans.
- 320 - Ditches shall conform to the slope, grade, dimensions, and shape of the required cross section shown on the plans. Roots, stumps, rocks, and other projections shall be removed to form smooth, even slopes.
- 321 - Excess excavated, unsuitable, or slide materials shall not be disposed of on areas where the material will encroach on a stream course or other body of water. Such materials shall be disposed of in accordance with Subsection 321c. Materials not disposed of in this manner shall be retrieved and disposed of at the Purchaser's expense and at the direction of the Authorized Officer.
- 321a - Excess construction materials specified under Subsection 321 shall be loaded, hauled, and placed as embankment for the roadbed on the following road section:

Road No.	Borrow: From Sta. to Sta.	Embankment: From Sta. to Sta.
4-7-28.3	1+00 – 11+61	11+61 – 21+08
4-7-33.5	0+20 – 1+70	1+70 – 3+21
4-7-33.7	0+23 – 2+31	2+31 – 2+68

- 321c - End-dumping will be permitted for the placement of excess materials under Subsection 321 in designated disposal areas or within areas approved by the Authorized Officer. Watering, rolling, and placement in layers are not required. Materials placed shall be sloped, shaped, and otherwise brought to a visible condition acceptable to the Authorized Officer.
- 322 - When so indicated on the plans, selected coarse rock encountered in the excavation shall be conserved for slope protection or special rock embankment

purposes and placed in accordance with the requirements and details of Section 1400 of these specifications and as shown on the plans.

- 323 - In the construction of channel changes and stream-crossing embankment sections, natural stream flow shall be maintained unless otherwise provided.
- 324 - Excavated material shall not be allowed to cover boles of standing trees to a depth in excess of a half (1/2) feet on the uphill side.
- 327 - The finished grading shall be approved by the Authorized Officer in segments or for the total project. The Purchaser shall give the Authorized Officer three (3) days' notice prior to final inspection of the grading operations.

PIPE CULVERTS - 400

- 401 - This work shall consist of furnishing and installing pipe culverts, downspouts, and other erosion control devices in accordance with these specifications and conforming to the lines, grades, dimensions, and typical cross sections shown on the plans. Individual lengths and locations are approximate; final lengths and locations will be determined by the Authorized Officer upon completion of the roadbed and upon installation of the appurtenance structures. Additional pipe and erosion control devices may be required at the option of the Authorized Officer, in which case a reduction in the total purchase price shall be made to offset the cost of furnishing and installing such items. Costs will be based upon the unit prices set forth in the current BLM Timber Appraisal Production Cost Schedule.
- 403 - Grade culverts shall have a gradient from two (2) percent to four (4) percent greater than the adjacent road grade. Grade culverts shall be skewed down grade thirty (30) degrees as measured from the perpendicular to the centerline unless otherwise specified on the plans.
- 404 - Damage to the spelter, or burn back in excess of three-eighths (3/8) inch, shall be wire brushed and painted with two coats of zinc-rich paint on zinc-coated steel pipe.
- 405a - Corrugated-(aluminized) steel-welded pipe culverts and pipe-arch culverts and special sections shall conform to the requirements of AASHTO M 36 and AASHTO M 218, AASHTO M 274, or AASHTO M 289 as specified on the plans.
- 405e - Corrugated-polyethylene pipe for culverts 18-inch through 24-inch diameter shall meet the requirements of AASHTO M 294, Type S.

Corrugated-polyethylene pipe for culverts to be used for downspouts 18-inch through 24-inch diameter shall meet the requirements of AASHTO M 294, Type C.

Installation will be subject to the same specification as other pipe materials.

- 406 - Coupling bands shall conform to the requirements of AASHTO M 36 and AASHTO M 274 with the exception of band widths and the "Hugger"-type band which shall conform to the details, dimensions, and typical diagram shown on the plans.
- 406a - "Hugger"-type coupling bands shall only be used with annular corrugated pipe and pipe-arch culverts, or helically corrugated pipe and pipe-arch culverts having annular reformed ends. Annular reformed ends shall consist of two annular corrugations.
- 406d - Pipe culvert @ 5-7-9.0 (MP 0.415) shall be connected with "Hugger"-type coupling bands using sleeve gaskets, "O"-ring neoprene gaskets, or 1-inch neoprene flat gaskets, as shown on Exhibit C (page 45) or as directed by Authorized Officer.
- 408 - Pipe culverts shall be placed on the bed starting at the downstream end with the inside circumferential laps pointing downstream and with the longitudinal laps at the side or quarter points. Coupling bands of the type required under these specifications shall be installed so as to provide the circumferential and longitudinal strength necessary to preserve the pipe alignment, prevent separation of the pipe sections, and minimize infiltration of fill material.
- 409 - Structural-plate pipe culverts and pipe-arch culverts shall be installed in accordance with the plans and detailed erection instructions furnished by the manufacturer. One copy of the erection instructions shall be submitted to the Authorized Officer (3) days prior to erection.
- 410 - Pipe shall be unloaded and handled with reasonable care. If the Authorized Officer determines any structure is damaged to the extent that it is unsuitable for use in the road construction, it shall be replaced at the Purchaser's expense.
- 411 - Trenches necessary for the installation of pipe culverts shall conform to the lines, grades, dimensions, and typical diagram included in the plans and the Culvert Installation Detail Sheet.
- 412 - Where ledge rock, boulders, soft, or spongy soils are encountered, they shall be excavated a minimum of twenty-four (24) inches below the invert grade for a width of at least one (1) pipe diameter or span on each side of the pipe and shall be backfilled with selected granular or fine readily compactable soil material or crushed rock material.

- 413 - All pipe culverts shall be bedded on a 1-1/2"-0" crushed rock material in accordance with Section 1200 gradation. Bedding shall have a depth of not less than six (6) inches as shown on plans. Foundation material shall be of uniform density throughout the length of the structure and shall be shaped to fit the pipe.
- 414a - The invert grade of the bedding shall be cambered at the middle ordinate a minimum of 1 percent of the total length of the drainage structure. Camber shall be developed on a parabolic curve.
- 415 - Inspection of pipe culverts having a diameter of (30) inches or a cross sectional area of (13) or larger shall be made before backfill is placed. Culverts found to be out of alignment or damaged shall be replaced, reinstalled or repaired as directed by the Authorized Officer at the Purchaser's expense.
- 416 - Side-fill material for pipe culverts shall be placed within one (1) pipe diameter, or a minimum of one (1) foot, of the sides of the pipe barrel, and to a half (1/2) pipe diameter on round pipes with 1-1/2"-0" crushed rock material in accordance with Section 1200 gradation if crushed bedding/backfill is required in the rock sheets and Section 413.

The remaining fill material shall be of fine, readily compactable soil and be free of excess moisture, muck, frozen material, roots, sod, or other deleterious or caustic material and devoid of rocks or stones of sizes which may impinge upon and damage the pipe or otherwise interfere with proper compaction.
- 419 - The pipe culverts, after being bedded and backfilled as required by these specifications, shall be protected by a minimum of 18" cover of fill before heavy equipment is permitted to cross the drainage structures.
- 421 - Trenches and bedding rock necessary for the installation of perforated pipe shall conform to the lines, grades, dimensions and typical diagram as shown on the plans or directed by Authorized Officer.
- 423 - Construction of catch basins conforming to lines, grades, dimensions and typical diagrams shown on the plans, shall be required for grade culverts.
- 424 - Construction of splash pads and energy dissipaters conforming to lines, grades, dimensions and typical diagram shown on the plans, shall be required for grade culverts and culverts as listed on the culvert sheet.
- 426 - Culvert markers consisting of six (6) foot steel fence posts painted blue shall be furnished, fabricated, and installed by the Purchaser at the inlet of all culverts (installed and existing) as marked. Marker shall be installed within six (6) inches of upslope side of culvert inlet.

- 427 - The Purchaser shall record culvert sizes, lengths and location actually installed on a copy of the culvert list. This culvert list shall be furnished to the Authorized Officer.
- 428 - The Purchaser shall remove and dispose of old culverts (removed in the construction phase) in a legal manner, off Government property, and pay any fees required. The Purchaser shall remove the old culverts from the work site prior to road acceptance.
- 429 - Keep the excavation site dewatered so that the installation of culverts is completed under dry conditions. Dispose of excess water by using pumping or natural drainage ways near the site in a manner that will avoid damage to adjacent property. Provide for downstream waterflow with no more than ten (10) percent increase in natural stream turbidity due to transport of excavated material or sediment during construction. Diversion streams shall not be returned to the natural channel until all in-stream work has been completed.
- 430 - During culvert installations or replacement activities, all stream flow shall be diverted around the culvert work occurring in live streams, as to maintain downstream flows and minimize turbidity. Woody material removed from stream channels during culvert work shall be placed in the stream channel downstream of the culvert.

RENOVATION AND IMPROVEMENT OF EXISTING ROADS - 500

- 501 - This work shall consist of reconditioning and preparing the roadbed and shoulders, minor excavation and/or embankment, cleaning and shaping drainage ditches, trimming vegetation from cut and embankment slopes, and cleaning and repairing drainage structures of existing roads in accordance with these specifications, as shown on the plans, and as marked on the ground.
- 501a - This work shall include the removal and disposal of slides in accordance with these specifications and as marked on the ground.
- 502 - The existing road surface shall be bladed and shaped to the lines, grades, dimensions, and typical cross sections shown on the plans.
- 502b - Drainage ditches shall be bladed and shaped in accordance with the lines, grades, dimensions, and typical cross sections shown on the plans.
- 503a - Material from the ditchline reestablishment excavation shall be hauled to designated disposal sites or at locations directed by the Authorized Officer.

- 504 - Existing road surface shall be uniformly moistened or dried to the optimum moisture content suitable for maximum density and compacted to full width with equipment conforming to requirements of Subsections 103f and 103i.
- 504a - Minimum compaction required shall be six (6) passes over each full-width layer, or fraction thereof, as measured along the centerline per layer of material.
- 506 - The inlet end of all existing drainage structures shall be cleared of vegetative debris and boulders that are of sufficient size to obstruct normal flow. Pipe inverts shall be cleared of sediment and other debris lodged in the barrel of the pipe. The outflow area of pipe structures shall be cleared of rock and vegetative obstructions which will impede the structure's designed outflow configuration. Catch basins shall conform to the lines, grade, dimensions, and typical diagram shown on the plans.
- 508 - Vegetation encroaching on the roadbed and the drainage ditches of existing roads shall be removed by cutting and disposed of in accordance with Subsection 2100 of these specifications.
- 509 - The finished grading and compacting shall be approved by the Authorized Officer. The Purchaser shall give the Authorized Officer three (3) days notice prior to final inspection of the grading operations.

WATERING - 600

- 601 - This work shall consist of furnishing and applying water required for the compaction of embankments, roadbeds, backfills, base courses, surface courses, finishing and reconditioning of existing roadbeds, laying dust, or for other uses in accordance with these specifications.
- 602 - Water, when needed for compaction or laying dust, shall be applied at the locations, in the amounts, and during the hours as directed by the Authorized Officer. Amounts of water to be provided will be the minimum needed to properly execute the compaction requirements in conformance with these specifications.
- 603 - Water trucks used in this work shall be equipped with a distributing device of ample capacity and of such design as to ensure uniform application of water on the road bed.
- 604 - Water required under these specifications shall be obtained at the times and at the locations indicated below:

Willamette Meridian			Dates Available		
Common Name	Section	T	R	From	To
Bible Crk Rd/4-7-21.0 Junction pond	NE ¼ of the SW ¼ Sec. 21	04S	07W	TBD	TBD

Use of water sources are subject to applicable State water regulations. In the event that the required water is not available at the locations specified, water shall be obtained from a source approved by the Authorized Officer as permitted by Oregon Water Resources. A reduction shall be made in the total purchase price to reflect additional hauling distance based on rental rates from current BLM Timber Appraisal Cost Schedules. It is estimated that approximately one hundred twenty-eight thousand, fifty (128,050) gallons will be required for processing rock.

- 605 - The Purchaser shall secure the necessary water permits and pay all required water fees for use of the water sources specified under Subsection 604 for use of water sources approved by the Authorized Officer. Purchaser shall notify the Bureau of Land Management when an agreement has been met and shall provide a copy of the documentation.

AGGREGATE BASE COURSE - 700
PIT-RUN ROCK MATERIAL

- 701 - This work shall consist of furnishing, hauling, and placing pit-run rock material on fill slopes and ditchlines and as backfill material approved for placing pit-run materials in accordance with these specifications and conforming to the dimensions and typical cross sections shown on the plans.
- 702 - Pit-run rock materials used in this work shall be obtained from a commercial source or other sources selected by the Purchaser at his option, providing the materials furnished comply with these specifications and the sources are approved in writing by the Authorized Officer prior to use.
- 703 - Pit-run rock materials shall consist of talus rock, partly decomposed granite or basalt, or other approved materials. The materials shall be reasonably free from vegetative matter or other deleterious material.
- 704 - Pit-run rock material shall consist of native materials of such a size and grading that it can be taken directly from the source and placed on the road without crushing or screening.

- 705 - Pit-run rock material shall be placed in layers of sufficient thickness to accommodate the material as directed by Authorized Officer.
- 706 - Oversize material that cannot be accommodated in the layer shall be removed at the source, or before placement, and shall be disposed of as directed by the Authorized Officer.
- 708 - The Ditchline or culvert fill slopes, as shaped under sections 150, 300, 400, and 500 of these specifications, shall be approved by the Authorized Officer prior to placement of pit-run rock material.
- 709 - Pit-run rock material shall be placed on excavated ditchlines and culvert fill slopes, as indicated in sections 150, culvert sheets, and rock sheets, and as marked in field, and as directed by Authorized Officer.

AGGREGATE BASE COURSE - 1000
CRUSHED ROCK MATERIAL

- 1001 - This work shall consist of furnishing, hauling, and placing one or more layers of crushed rock material on roadbeds approved for placing crushed rock material, in accordance with these specifications and conforming to the dimensions and typical cross sections shown on the plans.

Material not conforming to these specifications will be rejected and shall be removed from the road or stockpile at the purchaser's expense.
- 1002a - Crushed rock materials used in this work may be obtained from a commercial source selected by the Purchaser at his option and expense providing that the rock materials selected comply with the specifications in this section.
- 1003 - Crushed rock material produced from gravel shall have two (2) manufactured fractured faces on sixty-five (65) percent, by weight, of the material retained on the No. 4 sieve. If necessary to meet the above requirements or to eliminate an excess of filler, the gravel shall be screened before crushing.
- 1004 - Crushed rock material shall consist of hard durable rock fragments conforming to the following gradation requirements:

TABLE 1004
AGGREGATE BASE COURSE
CRUSHED ROCK MATERIAL
Percentage by weight passing square mesh sieves
AASHTO T 11 & T 27

GRADATION

Sieve Designation	D
6-inch	100
3-inch	45-65
1-1/2-inch	-
1-inch	-
3/4-inch	-
No. 4	10 Max
No. 30	-
No. 40	-
No. 200	-

- 1004a - The Purchaser shall submit samples to a certified lab for testing for gradation requirements using AASHTO T 11 and AASHTO T 27 testing procedures and also perform testing for sand equivalency requirements using AASHTO T 176 testing procedures. The Purchaser shall provide test results upon request to the Authorized Officer.
- 1005 - Crushed rock material shall not exceed thirty-five (35) percent loss as determined by AASHTO T 96.
- 1006 - Crushed rock material shall show a durability value of not less than thirty-five (35) as determined by AASHTO T210.
- 1007 - That portion of crushed rock material passing the No. 40 sieve, including blending filler, shall have a liquid limit of not more than thirty (35) and a plasticity index of not less than four (4) and not more than twelve (12) as determined by AASHTO T 89 and AASHTO T 90.
- 1008 - If additional binder or filler material is necessary to meet the grading or plasticity requirements or for satisfactory bonding of the material, it shall be uniformly blended with the crushed rock material at the crushing and screening plant prior to placing on the road, unless otherwise agreed. The material for such purposes

shall be obtained from sources approved by the Authorized Officer and shall be free from stones, vegetative matter, and other deleterious materials.

- 1009 - Shaping and compacting of roadbed shall be completed and approved prior to placing crushed rock material, in accordance to the requirements of Subsections 300, 400, and 500. Notification for final inspection of base rock shall be three (3) days prior to the spreading of crushed cap rock.
- 1010 - Crushed rock material conforming to the requirements of these specifications shall be placed on the approved roadbed, turnarounds, turnouts, roadside landings, and landings in accordance with these specifications and conforming to the lines, grades, dimensions, and typical cross sections shown on the plans and marked on the ground. Compacted layers shall not exceed nine (4) inches in depth (per layer). Irregularities or depressions that develop during compaction of the top layer shall be corrected by loosening the material at these places and then adding or removing crushed rock material until the surface is smooth and uniform.
- 1010a - Crushed rock material used to repair or reinforce soft, muddy, frozen, yielding, or rutted roadbed shall not be construed as surfacing required by this specification unless approved by the Authorized Officer in advance.
- 1012 - Each layer of crushed rock material placed, processed, and shaped as specified shall be moistened or dried to a uniform moisture content suitable for maximum compaction, determined by Authorized Officer, and compacted to full width by compacting equipment conforming to the requirements of Subsections 103f and 103i . Minimum compaction shall be six (6) passes over each full-width layer, or fraction thereof.

AGGREGATE SURFACE COURSE – 1200
CRUSHED ROCK MATERIAL

- 1201 - This work shall consist of furnishing, hauling, and placing one (1) or more layers of crushed rock material on roadbeds, base courses, and culvert bedding approved for placing crushed rock material in accordance with these specifications and conforming to the dimensions and typical cross sections shown on the plans. Material not conforming to these specifications will be rejected and shall be removed from the road or stockpile at the purchaser's expense.
- 1202a - Crushed rock materials used in this work may be obtained from a commercial source selected by the Purchaser at his option and expense, providing the rock materials furnished comply with the specifications in this section.
- 1203 - When crushed rock material is produced from gravel, not less than seventy-five (75) percent by weight of the particles retained on the No. 4 sieve will have 4 manufactured fractured faces. If necessary to meet the above requirements or to eliminate an excess of filler, the gravel shall be screened before crushing.

- 1204 - Crushed rock material shall consist of hard durable rock fragments conforming to the following gradation requirements:

TABLE 1204
AGGREGATE SURFACE COURSE
CRUSHED ROCK MATERIAL
 Percentage by weight passing square mesh sieves
 AASHTO T 11 & T 27
 GRADATION

Sieve Designation	C
1-1/2-inch	100
1-inch	-
3/4-inch	60-90
1/2-inch	-
No. 4	30-55
No. 8	22-43
No. 30	11-27
No. 40	-
No. 200	3-15

- 1204a - The Purchaser submit samples to a certified lab or perform testing for gradation requirements using AASHTO T 11 and AASHTO T 27 testing procedures and also perform testing for sand equivalency requirements using AASHTO T 176 testing procedures. The Purchaser shall provide test results upon request to the Authorized Officer.
- 1205 - Crushed rock material retained on the No. 4 sieve shall have a percentage of loss of not more than thirty-five (35) at five hundred (500) revolutions, as determined by AASHTO T 96.
- 1206 - Crushed rock material shall show a durability value of not less than thirty-five (35) as determined by AASHTO T210.
- 1207 - That portion of crushed rock material passing the No. 40 sieve, including blending filler, shall have a liquid limit of not more than thirty-five (35) and a plasticity index of not less than four (4) and not more than twelve (12) as determined by AASHTO T 89 and AASHTO T 90.
- 1208 - If additional binder or filler material is necessary to meet the grading or plasticity requirements or for satisfactory bonding of the material, it shall be uniformly blended with the crushed rock material at the crushing and screening plant prior to

placing on the road, unless otherwise agreed. The material for such purposes shall be obtained from sources approved by the Authorized Officer and shall be free from stones, vegetative matter, and other deleterious materials.

- 1208a - Each layer of crushed rock material shall be thoroughly mixed on the roadbed by alternately blading, to full depth, until a uniform mixture has been obtained. The mixture shall then be spread to full width. When completed, the spreading shall produce a surface which is smooth, presents uniform shoulder lines, and conforms to the specified cross section.
- 1209 - Shaping and compacting of roadbed, base course, or culvert trench shall be completed and approved prior to placing crushed rock material, in accordance to the requirements of Subsections 300, 400, 500, and 700. Notification for final inspection of base rock shall be three (3) days prior to the spreading of crushed cap rock.
- 1210 - Crushed rock material conforming to the requirements of these specifications shall be placed on the approved roadbed, landings, turnarounds, turnouts, base courses, and culvert trenches in accordance with these specifications and conforming to the lines, grades, dimensions, and typical cross sections shown on the plans and marked on the ground. Compacted layers shall not exceed 4 inches in depth. When more than one (1) layer is required, each shall be shaped, processed, compacted, and approved by the Authorized Officer before the succeeding layer is placed.
- Irregularities or depressions that develop during compaction of the top layer shall be corrected by loosening the material at these places and then adding or removing crushed rock material until the surface is smooth and uniform.
- 1210a - Crushed rock material used to repair or reinforce soft, muddy, frozen, yielding, or rutted roadbed shall not be construed as surfacing required by this specification unless approved by the Authorized Officer in advance.
- 1212 - Each layer of crushed rock material placed, processed, and shaped as specified, shall be moistened or dried to a uniform moisture content suitable for maximum compaction, as determined by Authorized Officer, and compacted to full width by compacting equipment conforming to the requirements of Subsections 103f, 103g, and 103i . Minimum compaction shall be six (6) passes over each full-width layer, or fraction thereof.

SLOPE PROTECTION - 1400

- 1401 - This work shall consist of furnishing, hauling, and placing stone materials for slope protection structures, splash pads, and road blockages in accordance with

these specifications and conforming to the lines, grades, dimensions, and typical cross-sections shown on the plans. Material not conforming to these specifications will be rejected and shall be removed from the slope protection structure at the purchaser's expense and as directed by the Authorized Officer.

- 1402 - Stone material shall consist of hard angular quarry rock of such quality that it will not disintegrate on exposure to water or weathering, and shall be graded in accordance with these specifications.

Volume/ Cubic Foot	Average Dimension in inches	Approximate Weight in Pounds
12	27.5 x 27.5 x 27.5	2100
6	21.8 x 21.8 x 21.8	1050
4	19.1 x 19.1 x 19.1	700
3	17.3 x 17.3 x 17.3	525
1	12.0 x 12.0 x 12.0	175
2/3	10.5 x 12.0 x 12.0	120
1/2	9.5 x 9.5 x 9.5	88
1/3	8.3 x 8.3 x 8.3	60
1/4	7.6 x 7.6 x 7.6	44
1/6	6.6 x 6.6 x 6.6	30
1/8	6.0 x 6.0 x 6.0	22
1/100	2.6 x 2.6 x 2.6	2

- 1404 - The material shall be well graded from the smallest to the maximum size specified. Stones smaller than the specified ten (10) percent size shall consist of spalls and fine rock fragments so distributed as to provide a stable compact mass.

- 1405 - Rip rap shall conform to the following gradations:

TABLE 1405

Class	Approx. Cubic Dimension (inches)	Sphere Diameter (inches)	% of Total Volume Smaller than Size of Stone
3	14-16	21	100
	10-14	18	80
	5-10	12	50
	0-5	6	10
5	26-28	36	100
	20-26	32	80
	8-20	25	50
	0-8	10	10

Rocks smaller than six inches in diameter are not counted.

- 1405a - Stone materials shall show a durability value of not less than fifty (50) as determined by AASHTO T 210.
- 1406a - The embankment shall be placed in successive horizontal layers of sufficient depth to contain the maximum size rock present in the material. Spalls and finer fragments of stone other than specified in Subsection 1405 shall be used to chock the larger stones solidly in position and to fill voids between the major stones as laid in the embankment. The exposed face of the embankment shall be reasonably smooth and uniform; material shall be prevented from escaping beyond the toe of the structure
- 1407 - Determination of the acceptability of the slope protection material gradation will be through visual inspection and physical measurements by the Authorized Officer.
- 1408 - Trenches for slope protection structures shall be excavated to the lines, elevations, and typical diagram shown on the plans. They shall be of sufficient size to permit the placing of structure footing of the full widths and length shown. Trenches shall be approved by the Authorized Officer prior to placement of slope protection material.
- 1408a - Foundation trenches and other required excavation as shown on the plans shall be approved prior to placing the slope protection material.

EROSION CONTROL - 1700

- 1701 - This work shall consist of measures to control soil erosion or water pollution during the construction operation through the use of berms, dikes, dams, sediment basins, fiber mats, netting, gravel, mulches, grasses, slope drains, and other erosion control devices or methods in accordance with these specifications and conforming to the lines, grades, dimensions and typical cross sections shown on the plans.
- 1708 - Newly constructed and renovated roads to be carried over the winter period, shall be blocked to vehicular traffic and waterbars installed.
- 1708a - Road segments not completed during dry weather periods shall be winterized, by providing a well-drained roadway using waterbars, maintaining drainage, and performing additional measures necessary to minimize erosion and other damage to the roadway, as directed by the Authorized Officer. Portions of roads not having surface rock in place will be blocked or barricaded to prevent vehicular traffic. A winterization plan shall be submitted to the Authorized Officer no later than September 15th of each harvest season.

- 1711 - The Purchaser shall construct sediment catch basins with straw bales at the following locations: 4-7-21.0 (MP 0.440 & 0.481), 4-7-28.2 (MP 0.333, 0.341, & 0.531), 4-7-33.2 (Sta. 23+63 & 24+52), 5-7-8.1 (MP 0.179), 5-7-9.0 (MP 0.027, 0.046, 0.424, 0.897, 0.955, 1.332, 1.361, 1.700, & 1.706), 5-7-9.3 (Sta. 4+17 & 4+76), 5-7-10.1 (MP 0.111, 0.202, & 0.434), and 5-7-10.2 (Sta. 29+65, 30+23, 47+42, 55+10, 73+38, 74+35, 103+20, 105+80 (both sides of road), 108+77, & 109+45). Construct sediment catch basins to the dimensions of the sediment catch basin detail on Pg. 51 of Exhibit C.
- 1711a - The Purchaser shall place straw bales in ditchline before existing sediment catch basins at the following locations: 4-7-28.2 (MP 0.296 & 0.699). Final sediment catch basin dimensions and configuration shall be as on detail on Pg. 38 of Exhibit C.
- 1711b - Straw bales required for sediment catch basins shall be furnished by the Purchaser. Straw bales shall be certified weed free from commercial grain fields and native grass fields. Straw bales shall be from oats, wheat, rye, or other approved grain crops and shall be free from, mold, or other objectionable material. Straw bales shall be in an air-dry condition and suitable for placement. The Purchaser shall provide the weed free certification to the Authorized Officer upon request.

SOIL STABILIZATION – 1800

- 1801 - This work shall consist of seeding on designated cut, fill, borrow, disposal, and special areas in accordance with these specifications and as shown on the plans. This work is not required for road acceptance under Section 18 of this contract. Grass seed will be furnished by the Government. Straw Mulch shall be furnished by the Government.
- 1802a - Soil stabilization work consisting of seeding and mulching shall be performed on new road construction, road renovation and improvement, landings, borrow sites, and disposal sites in accordance with these specifications and as shown on the plans. The seed shall be spread at a rate of sixty (60) pounds/acre, (to be determined by the Authorized Officer based on visual observation of trial applications).
- 1803 - Soil stabilization work as specified under Subsection 1802a shall be performed during the following seasonal periods:

From	To
August 1	October 15

The Authorized Officer may modify the above seasonal dates to conform to existing weather conditions and changes in the construction schedule.

- 1809 - Mulch material conforming to the requirements of Subsections 1809a and 1809b shall be furnished by the Government and shall be delivered to the work area in a dry state. Material to be used in the mulching operation may be stockpiled along the road designated for treatment.
- 1809a - Straw mulch shall be from oats, wheat, rye, or other approved grain crops which are free from noxious weeds, mold, or other objectionable materials. Straw mulch shall be in an air-dry condition and suitable for placing with power spray equipment.
- 1809b - Grass straw mulch shall be from perennial grass or, if specified, an annual rye grass, from which the seed has been removed. The straw shall be free from Bentgrass, Canada Thistle, Tansy Ragwort, Skeleton weed, and other noxious weed seed. The grass straw shall be from fields which have passed the current year's field inspection of the Oregon Grass Seed Certification program, or from fields certified by the County Agent, or by seed companies purchasing the seed.
- 1810 - Bulk mulching material required under these specifications shall be delivered to the work area bound either by twine, string or hemp rope. Wire binding will not be permitted.
- 1811 - The Purchaser shall apply to the disturbed soils that are wet and/or within fifty (50) feet each side of "live stream" locations and all disposal sites a mixture of grass seed and straw mulch material at the application rate of six (6) pounds seed/acre and three thousand (3000) pounds straw mulch/acre (to be determined by Authorized Officer based on visual observation of trial applications).
- 1814 - The Purchaser may reduce the application rate on partially covered slopes and refrain from application on areas already well stocked with grass or on rock surfaces as determined by the Authorized Officer.
- 1815b - Dry Method - Blowers, mechanical seeders, seed drills, landscape seeders, cultipaker seeders, fertilizer spreaders, or other approved mechanical seeding equipment may be used when seed and fertilizer are to be applied in dry form.
- 1819 - The Purchaser shall notify the Authorized Officer at least three (3) days in advance of date he intends to commence the specified soil stabilization work.

- 1824 - Twine, rope, sacks, and other debris resulting from the soil-stabilization operation shall be picked up and disposed of to the satisfaction of the Authorized Officer.

ROADSIDE BRUSHING - 2100

- 2101 - This work shall consist of the removal of vegetation from the road prism - variable distance, and inside curves in accordance with these specifications and conforming to the lines, grades, dimensions, and typical cross sections shown on the Roadside Brushing Detail Sheet of this exhibit, at designated locations as shown in the plans.
- 2102 - Roadside brushing may be performed mechanically with self-powered, self-propelled equipment, or manually with hand tools, including chain saws.
- 2103 - Vegetation cut manually or mechanically less than six (6) inches in diameter shall be cut to a maximum height of two (2) inches above the ground surface or above obstructions such as rocks or stumps on cut and fill slopes and all limbs below the six (6) inch area will be severed from the trunk.
- 2104 - Trees in excess of six (6) inches in diameter shall be limbed, so that no limbs extend into the treated area or over the roadbed to a height of fourteen (14) feet above the running surface of the roadway on cut and fill slopes, within the road prism-variable distance. Limbs shall be cut to within four (4) inches of the trunk to produce a smooth vertical face. Removal of trees larger than six (6) inches in diameter for sight distance or safety may be directed by the Authorized Officer.
- 2105 - Vegetation that is outside of the road prism-variable distance that protrudes into the road prism and within fourteen (14) feet in elevation above the running surface shall be cut, to within four (4) inches of the trunk to produce a smooth vertical face.
- 2106 - Vegetative growth capable of growing one (1) foot in height or higher shall be cut, within the road prism-variable distance or as directed by the Authorized Officer.
- 2107 - Inside curves shall be brushed out for a sight distance of two hundred (200) feet chord distance and/or a middle ordinate distance of twenty-five (25) feet, whichever is achieved first. Overhanging limbs and vegetation in excess of one (1) foot in height, shall be cut within these areas.
- 2109 - Debris resulting from this operation shall be scattered downslope from the roadway. Debris shall not be allowed to accumulate in concentrations. Debris in excess of one (1) foot in length and two (2) inches in diameter shall not be allowed to remain on cut slopes, ditches, roadways or water courses, or as directed by the Authorized Officer.

2112 - Roadside brushing shall be performed during the following seasonal periods:

*From	To
June 1	October 15

*Brushing may occur during the “wet season” given the following guidelines are followed:

- 1) Activity would be suspended when conditions exist that could generate sediment inputs into streams, such as times of intense or prolonged rainfall where water in ditches is flowing, or streamflow, as measured above and below the effects of the road, becomes discolored.
- 2) Activity would be suspended when road surface shows signs of serious deterioration such as excessive rutting or pumping of fines from the sub-grade.
- 3) Activity would be suspended upon decision of Authorized Officer.

2113 - Roadside brushing shall be accomplished on the following road segments: 4-7-21.0, 4-7-28.2, 5-7-3.1, 5-7-8.1, 5-7-8.2, 5-7-8.6, 5-7-8.7, 5-7-9.0, 5-7-9.3, 5-7-10.0, 5-7-10.1, 5-7-10.2, 5-7-10.3, and Coast Creek County Road.

2116 - Traffic warning signs shall be required at each end of the work area. Signs shall meet the requirements of the Manual on Uniform Traffic Devices.

BARRICADES AND CONTROL DEVICES - 2700

2701 - This work will consist of furnishing and placement of barricades, warning signs, and other protection required to prevent injury to people and damage to property due to culvert installations, brushing, and other construction work. Purchaser shall submit a site plan showing how the specifications in this section and of Sec. 42 will be accomplished.

2702 - Maintain condition, operation, and effectiveness of traffic control devices throughout period of use. Materials used for the temporary structures and controls are property of Contractor and shall be removed from Government land when need for their service has ended.

United States Department of Interior
 BUREAU OF LAND MANAGEMENT
 NORTHWEST OREGON DISTRICT - OREGON



T. 04S. R. 07W. Section 33 W.M. - NORTHWEST OREGON DISTRICT - OREGON
 T. 05S. R. 07W. Sections 03, 08, & 09 W.M. - NORTHWEST OREGON DISTRICT - OREGON

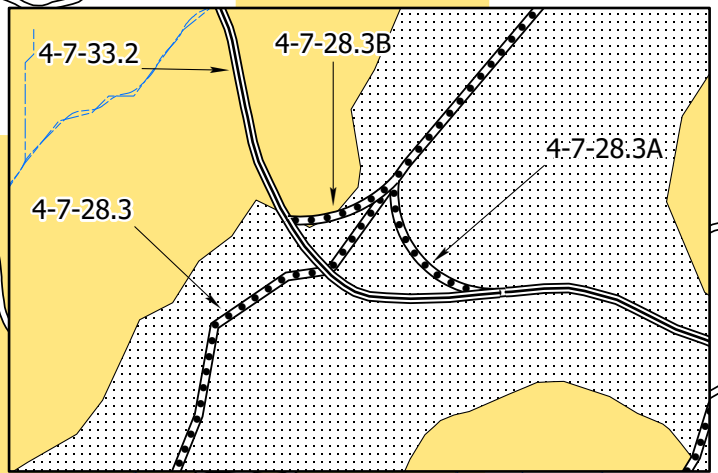
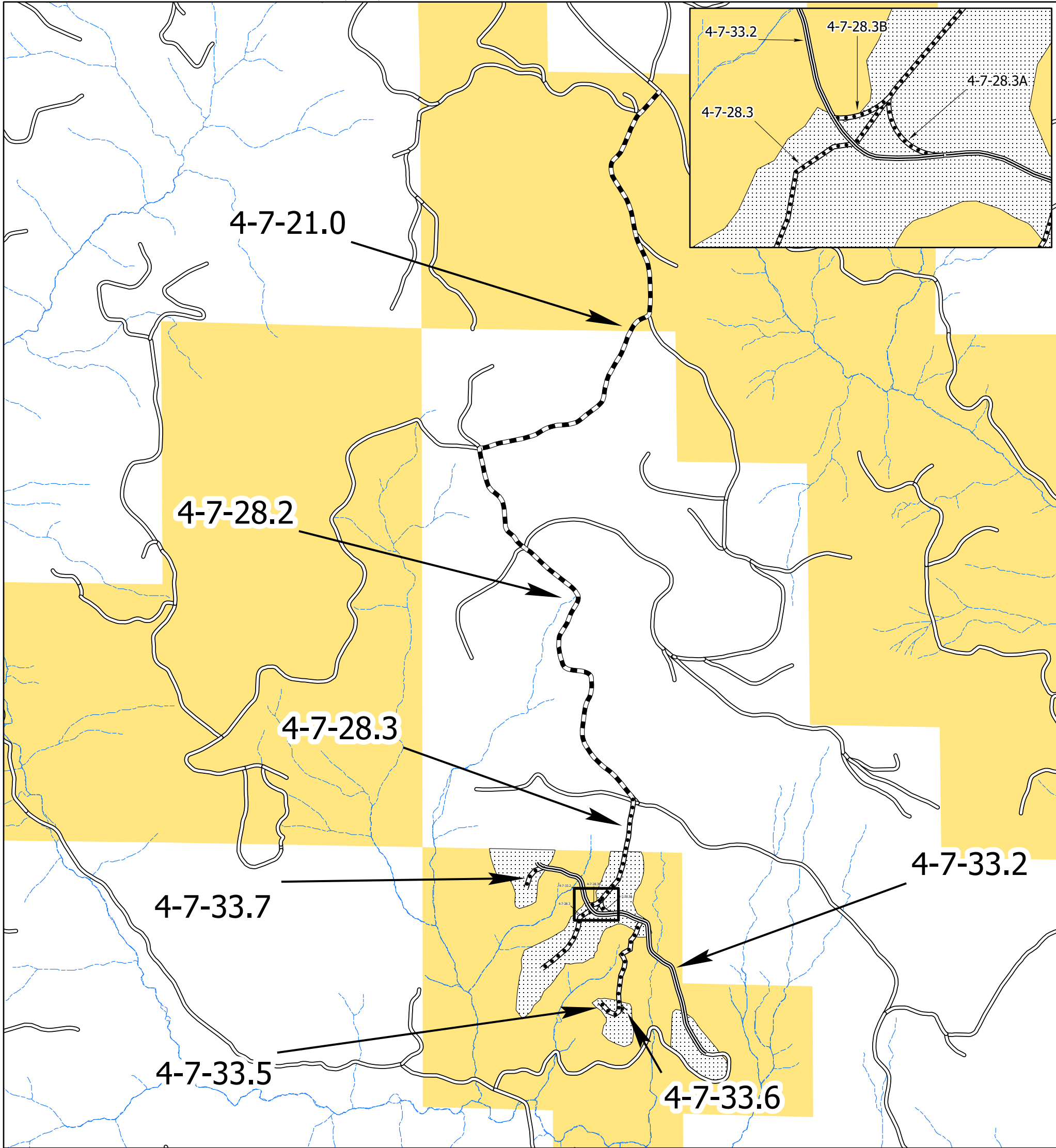

- Natural surfaced road to be constructed, Decommission after use
- Rocked surfaced road to be renovated, Open after use
- Natural surfaced road to be renovated, Stabilize after use
- Existing Roads
- Streams
- Big Mape Project Area
- Bureau of Land Management

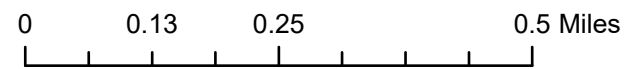

No warranty is made by the Bureau of Land Management as to the accuracy, reliability, or completeness of these data for individual or aggregate use with other data. Original data were compiled from various sources and may be updated without notification. Prepared By: Austin Bettis

United States Department of Interior
 BUREAU OF LAND MANAGEMENT
 NORTHWEST OREGON DISTRICT - OREGON
 Road Plan Map



T. 04S. R. 07W. Section 33 W.M. - NORTHWEST OREGON DISTRICT - OREGON
 T. 05S. R. 07W. Sections 03, 08, & 09 W.M. - NORTHWEST OREGON DISTRICT - OREGON

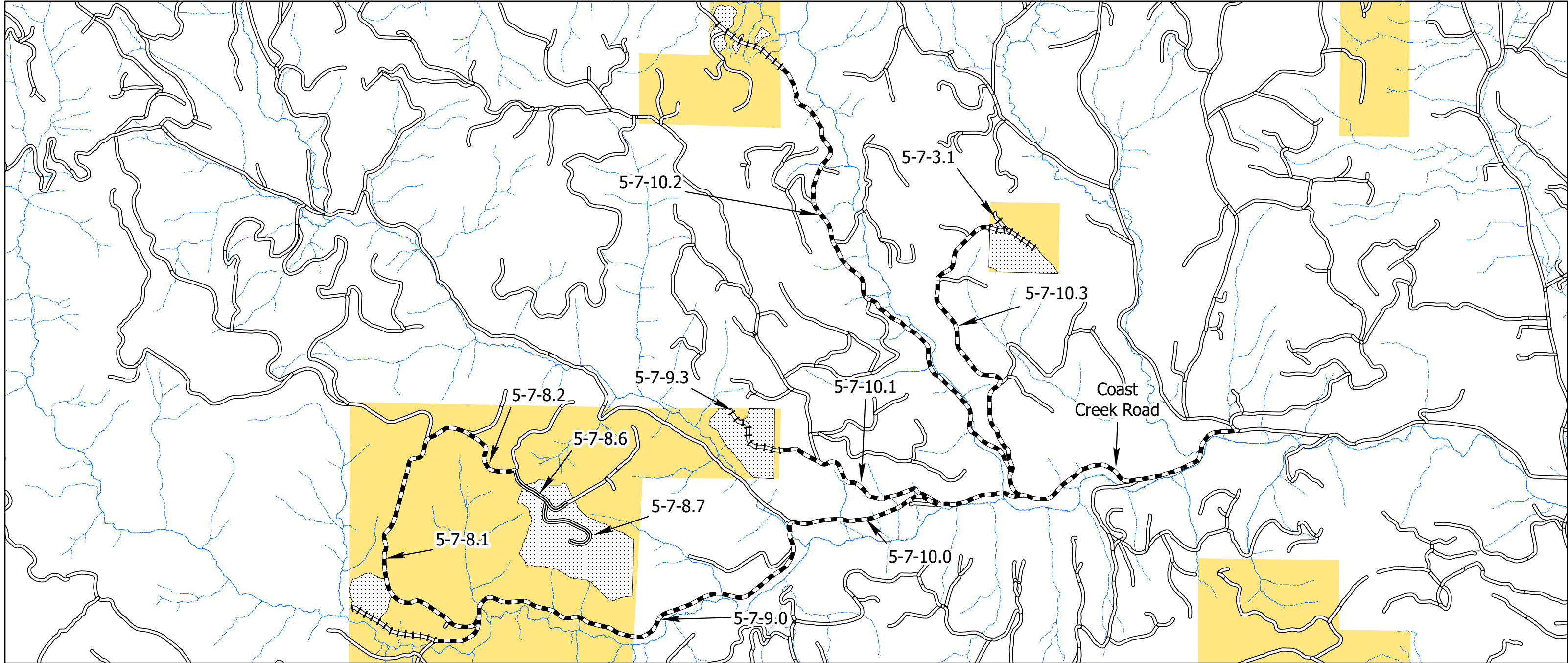

- Rocked surfaced road to be renovated, Open after use
- Rocked surfaced road to be renovated, Stabilize after use
- Natural surfaced road to be renovated, Stabilize after use
- Existing Roads
- Streams
- Big Mape Project Area
- Bureau of Land Management

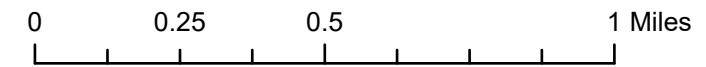

No warranty is made by the Bureau of Land Management as to the accuracy, reliability, or completeness of these data for individual or aggregate use with other data. Original data were compiled from various sources and may be updated without notification. Prepared By: Austin Bettis

U.S. DEPT. OF THE INTERIOR
 Bureau of Land Management
 NORTHWEST OREGON DISTRICT OFFICE - OREGON

Earth Barricade, Waterdip, Drivable and Non-Drivable Waterbar Details

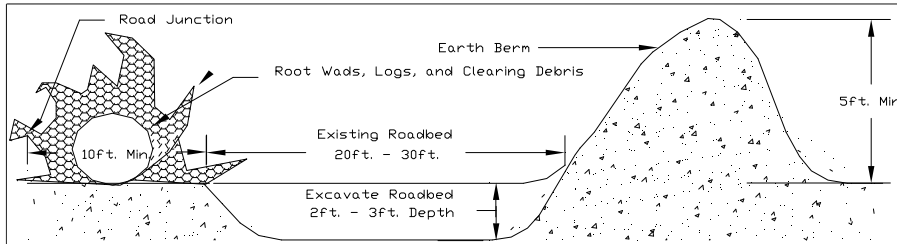

EARTH BARRICADE CONSTRUCTION

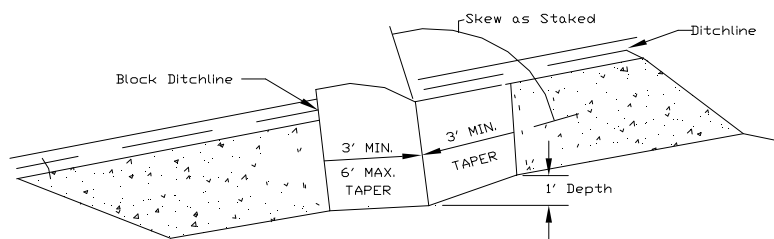

NOTE:

1. DITCHLINE IS TO BE BLOCKED WITH EXCAVATED MATERIAL TO PREVENT DITCH WATER FROM BYPASSING WATERBAR.
2. EXCESS MATERIAL SHALL BE UNIFORMLY SPREAD ALONG ROADWAY. NO MATERIAL WILL BE ALLOWED BEYOND THE OUTER ROAD EDGE.

DRIVABLE WATERBAR CONSTRUCTION

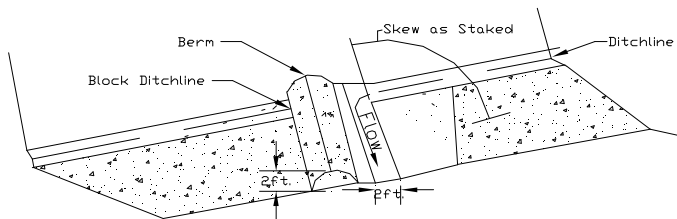

NON-DRIVABLE WATERBAR CONSTRUCTION

WATER DIP DETAIL

Not to Scale

NOTE: PLAN OF DIP SHOWN IS FOR OUTSLOPED ROLLING DIP, DIPS MAY BE EITHER INSLOPED OR OUTSLOPED. WHEN INSLOPED, DIPS SHALL DISCHARGE INTO A CULVERT, DROP INLET, OR OVERSIDE DRAIN, OR DRAINAGE DITCH. WHEN OUTSLOPED, THEY SHALL DISCHARGE INTO AN OVERSIDE DRAIN OR ON TO NATURAL GROUND. THE MINIMUM CROSS GRADE FROM "B" TO "E" IS 4% GREATER THAN THE ORIGINAL ROAD GRADE. SKEW LINE B-E TO FIT LOW POINT IN DRAW, IF LOCATED IN NATURAL DRAIN.

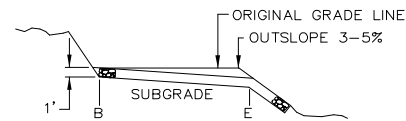
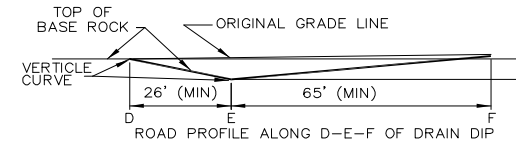
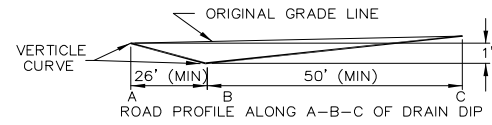
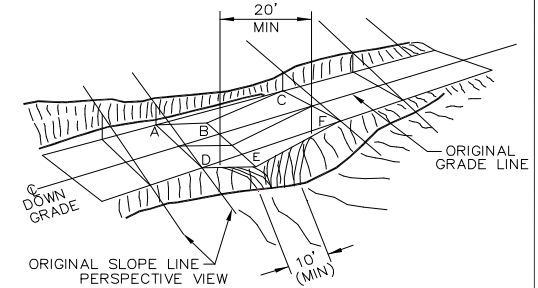

ROCK SPILL APRON 15' WIDE WITH MATERIAL AS SHOWN ON SCHEDULE OF ITEMS TO TOE OF FILL.

U.S. DEPT. OF THE INTERIOR
 Bureau of Land Management
 NORTHWEST OREGON DISTRICT OFFICE - OREGON

BRUSHING DETAILS

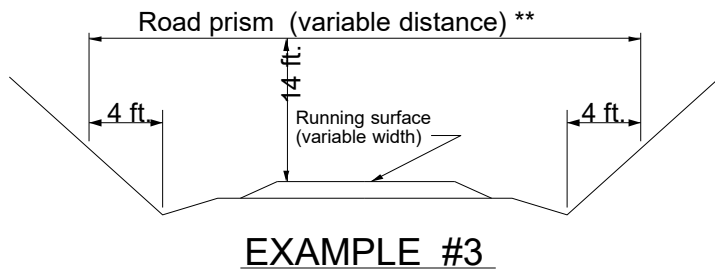
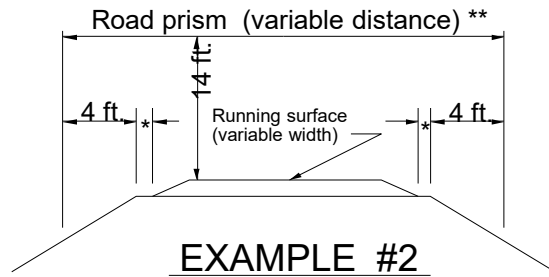
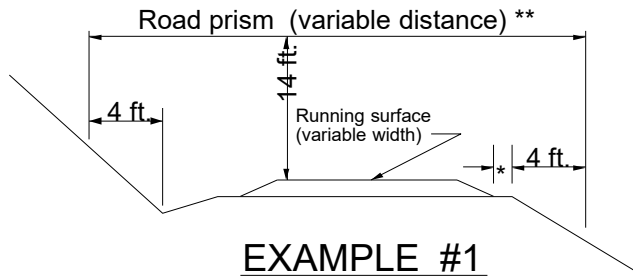

(NO SCALE)

- * Variable distance between running surface and start of fill slope
- ** All areas within the variable distance shall be free of all vegetation capable of growing one (1) foot in height or higher and all overhanging limbs and branches 14 feet in elevation above the running surface

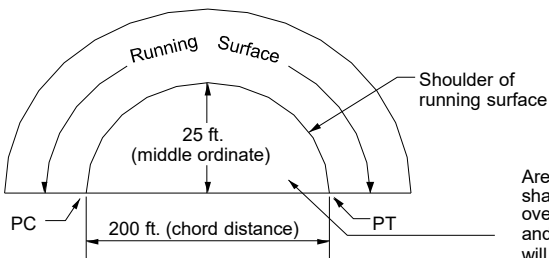

SIGHT DISTANCE DIAGRAM

Area to be cut: shall be free of overhanging limbs and all vegetation will be cut to a maximum height of one (1) foot.

U.S. DEPT. OF THE INTERIOR
Bureau of Land Management
NORTHWEST OREGON DISTRICT OFFICE - OREGON
Sediment Catch Basin with Straw Bale Details

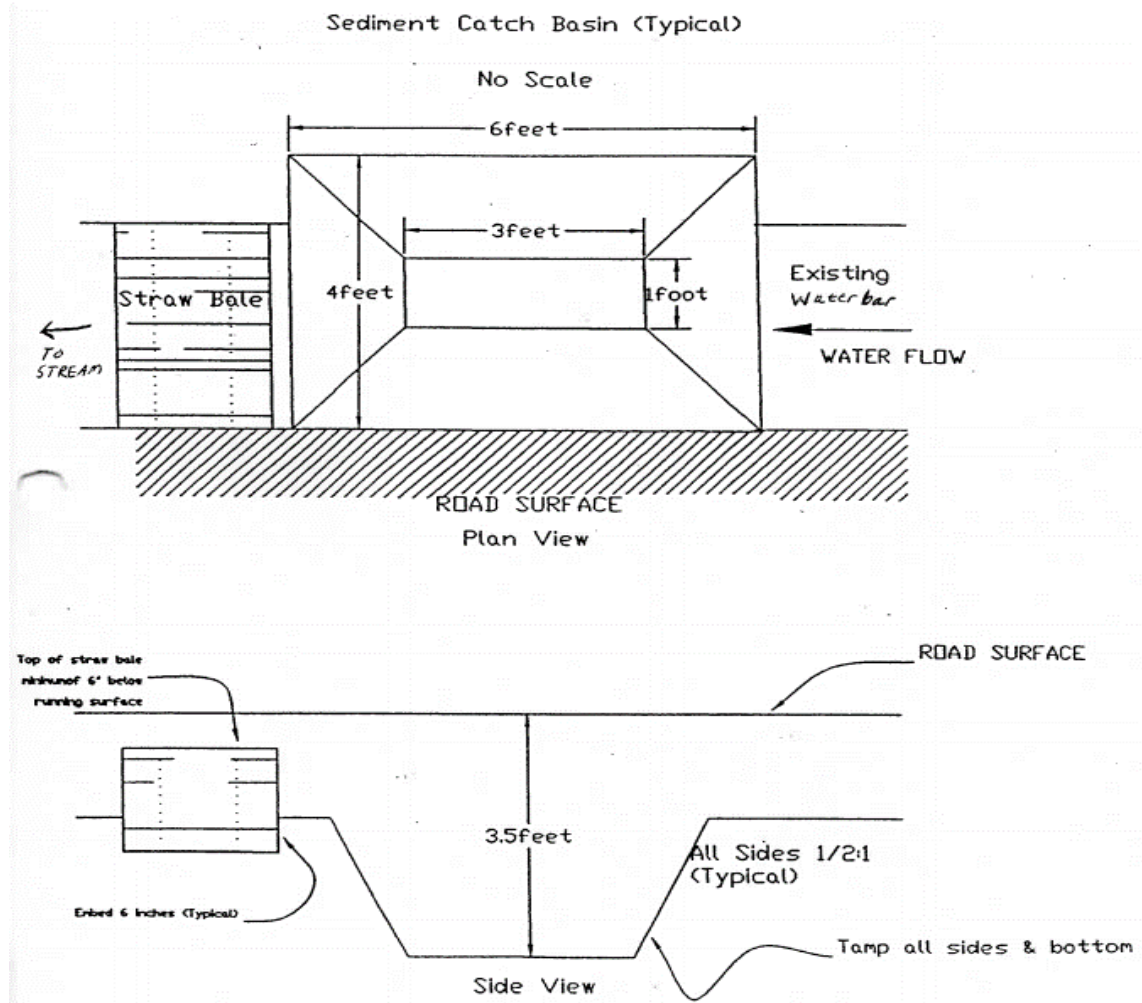

Culvert List

CULVERT LOCATIONS							DOWNSPOUT(d) or STANDPIPE(s) *4				AS BUILT			ROCK			REMARKS *6
DESIGNED *2														RIP RAP (GRADING)			
Road #	Sta./ M.P	SIZE	GAGE	LENGTH	CULVERT GRADE	INSTALL TYPE *3	SIZE	TYPE	LENGTH	TYPE OF ELBOW *5	SIZE	GAGE	LENGTH	(a) INLET	(b) OUTLET	Structure inside pipe	
4-7-21.0	0.129	--	--	--	--	--	--	--	--	--	--	--	--	--	--	--	Install metal inlet marker on existing CMP.
	0.207	--	--	--	--	--	18"	1	10'	--	--	--	--	--	--	--	Install downspout on existing CMP as marked in the field and directed by Authorized Officer. Install metal inlet marker.
	0.397	18"	--	30'	--	--	--	--	--	--	--	--	--	--	--	--	Install Culvert as marked in field and directed by Authorized Officer. Place 10 CY 1-1/2"-0" Crushed Bedding/Backfill Rock. Spread 10 CY 6" Jaw-Run over Pipe as surfacing, capped with 10 CY 1-1/2"-0" Crushed. Install metal inlet marker.
	0.472	--	--	--	--	--	--	--	--	--	--	--	--	--	--	--	Install metal inlet marker on existing CMP.
	0.749	18"	--	30'	--	--	18"	1	10'	--	--	--	--	--	--	--	Install Culvert and downspout as marked in field and directed by Authorized Officer. Place 10 CY 1-1/2"-0" Crushed Bedding/Backfill Rock. Spread 10 CY 6" Jaw-Run over Pipe for surfacing, capped with 10 CY 1-1/2"-0" Crushed. Install metal inlet marker.
4-7-28.2	0.112	--	--	--	--	--	--	--	--	--	--	--	--	--	--	--	Install metal inlet marker on existing CPP.
	0.217	--	--	--	--	--	--	--	--	--	--	--	--	--	--	--	Install metal inlet marker on existing CPP.
	0.336	--	--	--	--	--	--	--	--	--	--	--	--	10	--	--	Place 10 CY Class 3 RipRap @ outlet as dissipater.
	0.455	--	--	--	--	--	--	--	--	--	--	--	--	--	--	--	Install metal inlet marker on existing CPP.
	0.509	--	--	--	--	--	--	--	--	--	--	--	--	--	--	--	Install metal inlet marker on existing CPP.
	0.704	--	--	--	--	--	--	--	--	--	--	--	--	--	--	--	Install metal inlet marker on existing CPP.
	0.774	--	--	--	--	--	--	--	--	--	--	--	--	--	--	--	Install metal inlet marker on existing CPP.
4-7-28.3	0+75	18"	--	80'	--	--	--	--	--	--	--	--	--	--	--	--	Install Culvert as marked in the field and directed by Authorized Officer. Place 40 CY 1-1/2"-0" Crushed Bedding/Backfill Rock. Spread 40 CY 6" Jaw Run Base Rock over Pipe for Surfacing, capped with 30 CY 1-1/2"-0" Crushed Rock as marked. Install metal inlet marker.
	11+61	18"	--	35'	--	--	--	--	--	--	--	--	--	--	--	--	Install Culvert as marked in the field and directed by Authorized Officer. Place 15 CY 1-1/2"-0" Crushed Bedding/Backfill Rock. Spread 15 CY 6" Jaw Run Base Rock over Pipe for Surfacing, capped with 10 CY 1-1/2"-0" Crushed Rock as marked. Excavate a lead-off ditch from culvert outlet (approx. 10ft). Install metal inlet marker.
4-7-33.2	1+06	18"	--	30'	--	--	--	--	--	--	--	--	--	--	--	--	Install Culvert as marked in the field and directed by Authorized Officer. Place 10 CY 1-1/2"-0" Crushed Bedding/Backfill Rock. Spread 10 CY 6" Jaw Run Base Rock over Pipe for Surfacing, capped with 10 CY 1-1/2"-0" Crushed Rock as marked. Install metal inlet marker.
	3+55	18"	--	30'	--	--	--	--	--	--	--	--	--	--	--	--	Install Culvert as marked in the field and directed by Authorized Officer. Place 10 CY 1-1/2"-0" Crushed Bedding/Backfill Rock. Spread 10 CY 6" Jaw Run Base Rock over Pipe for Surfacing, capped with 10 CY 1-1/2"-0" Crushed Rock as marked. Install metal inlet marker.
	6+25	18"	--	45'	--	--	--	--	--	--	--	--	--	--	--	--	Install Culvert as marked in the field and directed by Authorized Officer. Place 20 CY 1-1/2"-0" Crushed Bedding/Backfill Rock. Spread 20 CY 6" Jaw Run Base Rock over Pipe for Surfacing, capped with 15 CY 1-1/2"-0" Crushed Rock as marked. Install metal inlet marker.
	11+29	36"	16	44'	--	--	--	--	--	--	--	--	--	--	--	--	Stream. (Approx. 7' fill @ CL). Replace existing CMP as marked in the field and directed by Authorized Officer. Place 25 CY 1-1/2"-0" Crushed Bedding/Backfill Rock. Spread 20 CY 6" Jaw Run Base Rock over Pipe for Surfacing, capped with 15 CY 1-1/2"-0" Crushed Rock as marked. Install metal inlet marker.
	11+69	18"	--	35'	--	--	--	--	--	--	--	--	--	--	--	--	Install Culvert as marked in the field and directed by Authorized Officer. Place 15 CY 1-1/2"-0" Crushed Bedding/Backfill Rock. Spread 15 CY 6" Jaw Run Base Rock over Pipe for Surfacing, capped with 10 CY 1-1/2"-0" Crushed Rock as marked. Install metal inlet marker.

Gage Chart		
Gage	Dec. Inches	
	Steel	Alum.
10	.138	.135
12	.109	.105
14	.079	.075
16	.064	.060

1. Designed culvert lengths and locations are approximate.

*2. all culverts have 2-2/3" x 1/2"

unless otherwise noted.

**** Corrugated plastic pipe (CPP), Type S (double wall) shall be used for culvert sizes 24" and smaller. All larger culverts shall be aluminized steel. All aluminized steel culverts are to have hugger type bands and neoprene gaskets. Culverts 20' in length or smaller shall be one piece (no joints). No Culvert piece shall be shorter than 6 foot. Minimization of banding is required.

*4. Downspout or Standpipe Types

- 1) Full
- 2) Half
- 3) Flume

*** Downspouts and stand pipes (under 36" diameter) shall be CPP, Type C (single wall).

- *5. 1) Conventional or Fabricated
 2) Turner type
 3) Slip joint

*6. Include special sections, structures, headwalls, footings & other data.

Culvert List

CULVERT LOCATIONS							DOWNSPOUT(d) or STANDPIPE(s) *4				AS BUILT			ROCK			REMARKS *6
DESIGNED *2														RIP RAP (GRADING)			
Road #	Sta./ M.P	SIZE	GAGE	LENGTH	CULVERT GRADE	INSTALL TYPE *3	SIZE	TYPE	LENGTH	TYPE OF ELBOW *5	SIZE	GAGE	LENGTH	(a) INLET	(b) OUTLET	Structure inside pipe	
4-7-33.2 (cont.)	13+47	18"	--	35'	--	--	--	--	--	--	--	--	--	--	--	--	Install Culvert as marked in the field and directed by Authorized Officer. Place 15 CY 1-1/2"-0" Crushed Bedding/Backfill Rock. Spread 15 CY 6" Jaw Run Base Rock over Pipe for Surfacing, capped with 10 CY 1-1/2"-0" Crushed Rock as marked. Excavate a lead-off ditch from culvert outlet (approx. 20ft). Install metal inlet marker.
	17+25	18"	--	40'	--	--	--	--	--	--	--	--	--	--	--	--	Install Culvert as marked in the field and directed by Authorized Officer. Place 20 CY 1-1/2"-0" Crushed Bedding/Backfill Rock. Spread 20 CY 6" Jaw Run Base Rock over Pipe for Surfacing, capped with 15 CY 1-1/2"-0" Crushed Rock as marked. Install metal inlet marker.
	21+75	18"	--	35'	--	--	--	--	--	--	--	--	--	--	--	--	Install Culvert as marked in the field and directed by Authorized Officer. Place 15 CY 1-1/2"-0" Crushed Bedding/Backfill Rock. Spread 15 CY 6" Jaw Run Base Rock over Pipe for Surfacing, capped with 10 CY 1-1/2"-0" Crushed Rock as marked. Install metal inlet marker.
	24+06	--	--	--	--	--	--	--	--	--	--	--	--	--	--	--	Remove existing CMP. Backfill trench with local suitable material. Surface with Jaw-Run and Crushed on culvert installation ahead.
	24+16	36"	16	44'	--	--	--	--	--	--	--	--	--	5	25	--	Stream Crossing. Install Culvert as marked in field and directed by Authorized Officer (approx. 7' fill @ CL). Place 25 CY 1-1/2"-0" Crushed Bedding/Backfill Rock. Spread 30 CY 6" Jaw Run Base Rock over Pipe for Surfacing, capped with 25 CY 1-1/2"-0" Crushed Rock. Place 5 CY Class 5 RipRap @ inlet as fill armor. Place 25 CY Class 5 RipRap @ outlet as stabilization wall/fill armor. Install metal inlet marker.
	25+77	18"	--	40'	--	--	--	--	--	--	--	--	--	--	--	--	Install Culvert as marked in the field and directed by Authorized Officer. Place 20 CY 1-1/2"-0" Crushed Bedding/Backfill Rock. Spread 20 CY 6" Jaw Run Base Rock over Pipe for Surfacing, capped with 15 CY 1-1/2"-0" Crushed Rock as marked. Install metal inlet marker. Construct lead-off ditch from culvert outlet (approx. 10 ft).
5-7-8.1	0.045	--	--	--	--	--	--	--	--	--	--	--	--	--	--	--	Install metal inlet marker on existing CMP.
	0.174	24"	--	40'	--	--	--	--	--	--	--	--	--	--	10	--	Intermittent Stream. Replace existing CMP as marked in field and directed by Authorized Officer (approx. 6' fill @ CL). Place 20 CY 1-1/2"-0" Crushed Bedding/Backfill Rock. Spread 20 CY 6" Jaw Run Base Rock over Pipe for Surfacing, capped with 15 CY 1-1/2"-0" Crushed Rock. Place 10 CY Class 3 RipRap @ outlet as fill armor/energy dissipater. Install metal inlet marker.
	0.243	18"	--	40'	--	--	--	--	--	--	--	--	--	--	--	--	Replace existing CMP as marked in field and directed by Authorized Officer (approx. 5' fill @ CL). Place 20 CY 1-1/2"-0" Crushed Bedding/Backfill Rock. Spread 20 CY 6" Jaw Run Base Rock over Pipe for Surfacing, capped with 15 CY 1-1/2"-0" Crushed Rock. Excavate lead-off ditch from culvert outlet (approx. 15ft). Install metal inlet marker.
	0.371	18"	--	40'	--	--	--	--	--	--	--	--	--	--	--	--	Replace Existing CMP as marked in the field and directed by Authorized Officer. Place 20 CY 1-1/2"-0" Crushed Bedding/Backfill Rock. Spread 20 CY 6" Jaw Run Base Rock over Pipe for Surfacing, capped with 15 CY 1-1/2"-0" Crushed Rock as marked. Install metal inlet marker.
	0.485	18"	--	40'	--	--	--	--	--	--	--	--	--	--	--	--	Replace Existing CMP as marked in the field and directed by Authorized Officer. Place 20 CY 1-1/2"-0" Crushed Bedding/Backfill Rock. Spread 20 CY 6" Jaw Run Base Rock over Pipe for Surfacing, capped with 15 CY 1-1/2"-0" Crushed Rock as marked. Install metal inlet marker.
	0.545	18"	--	40'	--	--	18"	1	20'	--	--	--	--	--	--	--	Replace Existing CMP as marked in the field and directed by Authorized Officer (approx. 6' fill @ CL). Install 20 ft downspout. Place 20 CY 1-1/2"-0" Crushed Bedding/Backfill Rock. Spread 20 CY 6" Jaw Run Base Rock over Pipe for Surfacing, capped with 15 CY 1-1/2"-0" Crushed Rock as marked. Install metal inlet marker.
	0.652	18"	--	40'	--	--	--	--	--	--	--	--	--	--	--	--	Install Culvert as marked in the field and directed by Authorized Officer. Place 20 CY 1-1/2"-0" Crushed Bedding/Backfill Rock. Spread 20 CY 6" Jaw Run Base Rock over Pipe for Surfacing, capped with 15 CY 1-1/2"-0" Crushed Rock as marked. Install metal inlet marker.
	0.760	18"	--	40'	--	--	--	--	--	--	--	--	--	--	--	--	Replace existing CMP as marked in field and directed by Authorized Officer (approx. 5' fill @ CL). Place 20 CY 1-1/2"-0" Crushed Bedding/Backfill Rock. Spread 20 CY 6" Jaw Run Base Rock over Pipe for Surfacing, capped with 15 CY 1-1/2"-0" Crushed Rock. Install metal inlet marker.
	0.825	18"	--	40'	--	--	--	--	--	--	--	--	--	--	--	--	Replace Existing CMP as marked in the field and directed by Authorized Officer. Place 20 CY 1-1/2"-0" Crushed Bedding/Backfill Rock. Spread 20 CY 6" Jaw Run Base Rock over Pipe for Surfacing, capped with 15 CY 1-1/2"-0" Crushed Rock as marked. Install metal inlet marker.
5-7-8.2	0.107	--	--	--	--	--	--	--	--	--	--	--	--	--	--	--	Spread 20 CY 6" Jaw Run Base Rock over Pipe for Surfacing, capped with 10 CY 1-1/2"-0" Crushed Rock as marked. Install metal inlet marker on existing CMP.
	0.227	18"	--	30'	--	--	--	--	--	--	--	--	--	--	--	--	Replace existing CMP as marked in field and directed by Authorized Officer (approx. 5' fill @ CL). Place 10 CY 1-1/2"-0" Crushed Bedding/Backfill Rock. Spread 10 CY 6" Jaw Run Base Rock over Pipe for Surfacing, capped with 10 CY 1-1/2"-0" Crushed Rock. Install metal inlet marker.
	0.313	18"	--	30'	--	--	--	--	--	--	--	--	--	--	--	--	Install Culvert as marked in the field and directed by Authorized Officer. Place 10 CY 1-1/2"-0" Crushed Bedding/Backfill Rock. Spread 10 CY 6" Jaw Run Base Rock over Pipe for Surfacing, capped with 10 CY 1-1/2"-0" Crushed Rock. Install metal inlet marker.

Gage Chart		
Gage	Dec. Inches	
	Steel	Alum.
10	.138	.135
12	.109	.105
14	.079	.075
16	.064	.060

1. Designed culvert lengths and locations are approximate.

*2. all culverts have 2-2/3" x 1/2"

unless otherwise noted.

**** Corrugated plastic pipe (CPP), Type S (double wall) shall be used for culvert sizes 24" and smaller. All larger culverts shall be aluminized steel. All aluminized steel culverts are to have hugger type bands and neoprene gaskets. Culverts 20' in length or smaller shall be one piece (no joints). No Culvert piece shall be shorter than 6 foot. Minimization of banding is required.

*4. Downspout or Standpipe Types

- 1) Full *** Downspouts and stand pipes (under 36" diameter) shall be CPP, Type C (single wall).
- 2) Half
- 3) Flume

*5. 1) Conventional or Fabricated
2) Turner type
3) Slip joint

*6. Include special sections, structures, headwalls, footings & other data.

Culvert List

CULVERT LOCATIONS							DOWNSPOUT(d) or STANDPIPE(s) *4				AS BUILT			ROCK RIP RAP (GRADING)			REMARKS *6
DESIGNED *2							SIZE	TYPE	LENGTH	TYPE OF ELBOW *5	SIZE	GAGE	LENGTH	(a)		(b)	
Road #	Sta./ M.P	SIZE	GAGE	LENGTH	CULVERT GRADE	INSTALL TYPE *3								INLET	OUTLET		
5-7-8.6	8+08	18"	--	30'	--	--	--	--	--	--	--	--	--	--	--	Install Culvert as marked in the field and directed by Authorized Officer. Place 10 CY 1-1/2"-0" Crushed Bedding/Backfill Rock. Spread 10 CY 6" Jaw Run Base Rock over Pipe for Surfacing, capped with 10 CY 1-1/2"-0" Crushed Rock as marked. Excavate lead-off ditch at outlet (approx. 10ft). Install metal inlet marker.	
5-7-8.7	0+25	18"	--	45'	--	--	--	--	--	--	--	--	--	--	--	Install Culvert as marked in the field and directed by Authorized Officer. Place 20 CY 1-1/2"-0" Crushed Bedding/Backfill Rock. Spread 20 CY 6" Jaw Run Base Rock over Pipe for Surfacing, capped with 15 CY 1-1/2"-0" Crushed Rock as marked. Excavate lead-off ditch at outlet (approx. 5ft). Install metal inlet marker.	
	5+14	18"	--	30'	--	--	--	--	--	--	--	--	--	--	--	Install Culvert as marked in the field and directed by Authorized Officer. Place 10 CY 1-1/2"-0" Crushed Bedding/Backfill Rock. Spread 10 CY 6" Jaw Run Base Rock over Pipe for Surfacing, capped with 10 CY 1-1/2"-0" Crushed Rock as marked. Excavate lead-off ditch at outlet (approx. 15ft). Install metal inlet marker.	
5-7-9.0 Coast Crk Rd	0.215	--	--	--	--	--	--	--	--	--	--	--	--	--	--	Install metal inlet marker on existing CMP.	
	0.415	48"	14	40'	--	--	--	--	--	--	--	--	5	35	--	Stream. Replace Existing CMP as marked in field and directed by Authorized Officer (approx. 8' fill @ CL). Place 35 CY 1-1/2"-0" Crushed Bedding/Backfill Rock. Spread 25 CY 6" Jaw Run Base Rock over Pipe for Surfacing, capped with 20 CY 1-1/2"-0" Crushed Rock. Place 5 CY Class 5 RipRap @ inlet as fill armor. Place 10 CY Class 5 RipRap @ outlet as energy dissipater (filling in vertical drop from outlet). Place 25 CY Class 5 RipRap @ outlet as fill armor. Install metal inlet marker.	
	0.951	36"	16	90'	--	--	--	--	--	--	--	--	30	100	--	Intermittent Stream. Replace Existing CMP as marked in field and directed by Authorized Officer (approx. 20' fill @ CL). Place 60 CY 1-1/2"-0" Crushed Bedding/Backfill Rock. Spread 40 CY 6" Jaw Run Base Rock over Pipe for Surfacing, capped with 30 CY 1-1/2"-0" Crushed Rock. Place 30 CY Class 5 RipRap @ inlet as fill armor. Place 100 CY Class 5 RipRap @ outlet as stabilization wall/fill armor. Place 20 CY Pit-Run @ inlet as fill armor above RipRap. Place 50 CY Pit-Run @ outlet as fill armor above RipRap. Install metal inlet marker.	
	1.088	24"	--	45'	--	--	--	--	--	--	--	--	--	10	--	Install Culvert as marked in field and directed by Authorized Officer. Place 20 CY 1-1/2"-0" Crushed Bedding/Backfill Rock. Spread 20 CY 6" Jaw Run Base Rock over Pipe for Surfacing, capped with 15 CY 1-1/2"-0" Crushed Rock. Place 10 CY Class 5 RipRap @ outlet as stabilization wall/fill armor. Place 10 CY Pit-Run @ outlet as fill armor above RipRap. Install metal inlet marker.	
	1.175	18"	--	45'	--	--	--	--	--	--	--	--	10	10	--	Replace Existing CMP as marked in field and directed by Authorized Officer (approx. 8' fill @ CL). Place 20 CY 1-1/2"-0" Crushed Bedding/Backfill Rock. Spread 20 CY 6" Jaw Run Base Rock over Pipe for Surfacing, capped with 15 CY 1-1/2"-0" Crushed Rock. Place 10 CY Class 5 RipRap @ inlet as fill armor. Place 10 CY Class 5 RipRap @ outlet as stabilization wall/fill armor. Install metal inlet marker.	
	1.388	18"	--	35'	--	--	--	--	--	--	--	--	--	5	--	Install culvert as marked in field and directed by Authorized Officer. Place 15 CY 1-1/2"-0" Crushed Bedding/Backfill Rock. Spread 15 CY 6" Jaw Run Base Rock over Pipe for Surfacing, capped with 10 CY 1-1/2"-0" Crushed Rock. Place 5 CY Class 5 RipRap @ outlet as energy dissipater. Install metal inlet marker.	
	1.467	18"	--	35'	--	--	--	--	--	--	--	--	--	--	--	Replace Existing CMP as marked in field and directed by Authorized Officer. Place 15 CY 1-1/2"-0" Crushed Bedding/Backfill Rock. Spread 15 CY 6" Jaw Run Base Rock over Pipe for Surfacing, capped with 10 CY 1-1/2"-0" Crushed Rock. Install metal inlet marker.	
	1.535	18"	--	35'	--	--	--	--	--	--	--	--	--	--	--	Replace Existing CMP as marked in field and directed by Authorized Officer. Place 15 CY 1-1/2"-0" Crushed Bedding/Backfill Rock. Spread 15 CY 6" Jaw Run Base Rock over Pipe for Surfacing, capped with 10 CY 1-1/2"-0" Crushed Rock. Install metal inlet marker.	
	1.702	36"	16	46'	--	--	--	--	--	--	--	--	--	10	--	Stream. Replace Existing CMP as marked in field and directed by Authorized Officer (approx. 7' fill @ CL). Place 30 CY 1-1/2"-0" Crushed Bedding/Backfill Rock. Spread 25 CY 6" Jaw Run Base Rock over Pipe for Surfacing, capped with 20 CY 1-1/2"-0" Crushed Rock. Place 10 CY Class 5 RipRap @ outlet as stabilization wall/fill armor. Install metal inlet marker.	
5-7-9.3	0+30	18"	--	30'	--	--	--	--	--	--	--	--	--	--	--	Install culvert as marked in field and directed by Authorized Officer. Place 10 CY 1-1/2"-0" Crushed Bedding/Backfill Rock. Spread 10 CY 6" Jaw Run Base Rock over Pipe for Surfacing, capped with 10 CY 1-1/2"-0" Crushed Rock. Install metal inlet marker.	
	4+46	24"	--	40'	--	--	--	--	--	--	--	--	--	20	--	Intermittent Stream. Replace Existing CMP as marked in field and directed by Authorized Officer (approx. 6' fill @ CL). Place 20 CY 1-1/2"-0" Crushed Bedding/Backfill Rock. Spread 20 CY 6" Jaw Run Base Rock over Pipe for Surfacing, capped with 15 CY 1-1/2"-0" Crushed Rock. Place 20 CY Class 5 RipRap @ outlet as stabilization wall/fill armor. Excavate bench approx. 8 feet below existing CMP invert to start RipRap placement. New CPP is to be installed at same elevations for inlet and outlet inverts. Install metal inlet marker.	
	10+16	18"	--	30'	--	--	--	--	--	--	--	--	--	--	--	Install culvert as marked in field and directed by Authorized Officer. Place 10 CY 1-1/2"-0" Crushed Bedding/Backfill Rock. Spread 10 CY 6" Jaw Run Base Rock over Pipe for Surfacing, capped with 10 CY 1-1/2"-0" Crushed Rock. Install metal inlet marker.	
	17+00	18"	--	35'	--	--	--	--	--	--	--	--	--	--	--	Install culvert as marked in field and directed by Authorized Officer. Place 15 CY 1-1/2"-0" Crushed Bedding/Backfill Rock. Spread 15 CY 6" Jaw Run Base Rock over Pipe for Surfacing, capped with 10 CY 1-1/2"-0" Crushed Rock. Excavate lead-off ditch (approx. 10 ft) from culvert outlet. Install metal inlet marker.	
	20+25	18"	--	40'	--	--	--	--	--	--	--	--	--	--	--	Install culvert as marked in field and directed by Authorized Officer. Place 20 CY 1-1/2"-0" Crushed Bedding/Backfill Rock. Spread 20 CY 6" Jaw Run Base Rock over Pipe for Surfacing, capped with 15 CY 1-1/2"-0" Crushed Rock. Excavate lead-off ditch (approx. 10 ft) from culvert outlet. Install metal inlet marker.	
5-7-10.0 Burton Crk Rd	0.009	--	--	--	--	--	--	--	--	--	--	--	--	--	--	Remove existing CMP. Backfill trench with local suitable material. Spread 40 CY 6" Jaw-Run Base Rock for Surfacing, capped with 20 CY 1-1/2"-0" Crushed Rock.	
	0.014	18"	--	40'	--	--	--	--	--	--	--	--	--	--	--	Install culvert as marked in field and directed by Authorized Officer. Place 20 CY 1-1/2"-0" Crushed Bedding/Backfill Rock. Spread 20 CY 6" Jaw Run Base Rock over Pipe for Surfacing, capped with 15 CY 1-1/2"-0" Crushed Rock. Excavate lead-off ditch (approx. 10 ft) from culvert outlet. Utility Locates will need to be done prior to digging. Install metal inlet marker.	
	0.089	--	--	--	--	--	--	--	--	--	--	--	--	--	--	Install metal inlet marker on existing CMP.	
	0.139	--	--	--	--	--	--	--	--	--	--	--	--	--	--	Install metal inlet marker on existing CMP.	
	0.237	36"	16	60'	--	--	--	--	--	--	--	--	--	15	--	Stream. Replace Existing CMP as marked in field and directed by Authorized Officer (approx. 7' fill @ CL). Place 35 CY 1-1/2"-0" Crushed Bedding/Backfill Rock. Spread 30 CY 6" Jaw Run Base Rock over Pipe for Surfacing, capped with 20 CY 1-1/2"-0" Crushed Rock. Place 10 CY Class 5 RipRap @ outlet as energy dissipater (fill in hole at outlet). Place 5 CY Class 5 RipRap @ outlet as fill armor. Culvert crosses driveway to left as well. Coordinate with homeowner. Utility Locates will need to be done prior to digging. Install metal inlet marker.	
	0.341	--	--	--	--	--	--	--	--	--	--	--	--	--	--	Install metal inlet marker on existing CMP.	

<table border="1"> <thead> <tr> <th colspan="3">Gage Chart</th> </tr> <tr> <th rowspan="2">Gage</th> <th colspan="2">Dec. Inches</th> </tr> <tr> <th>Steel</th> <th>Alum.</th> </tr> </thead> <tbody> <tr> <td>10</td> <td>.138</td> <td>.135</td> </tr> <tr> <td>12</td> <td>.109</td> <td>.105</td> </tr> <tr> <td>14</td> <td>.079</td> <td>.075</td> </tr> <tr> <td>16</td> <td>.064</td> <td>.060</td> </tr> </tbody> </table>	Gage Chart			Gage	Dec. Inches		Steel	Alum.	10	.138	.135	12	.109	.105	14	.079	.075	16	.064	.060	<p>1. Designed culvert lengths and locations are approximate.</p> <p>*2. all culverts have 2-2/3" x 1/2" unless otherwise noted.</p> <p>**** Corrugated plastic pipe (CPP), Type S (double wall) shall be used for culvert sizes 24" and smaller. All larger culverts shall be aluminized steel. All aluminized steel culverts are to have hugger type bands and neoprene gaskets. Culverts 20' in length or smaller shall be one piece (no joints). No Culvert piece shall be shorter than 6 foot. Minimization of banding is required.</p>	<p>*4. Downspout or Standpipe Types</p> <p>1) Full 2) Half 3) Flume</p> <p>*** Downspouts and stand pipes (under 36" diameter) shall be CPP, Type C (single wall).</p>	<p>*5. 1) Conventional or Fabricated 2) Turner type 3) Slip joint</p> <p>*6. Include special sections, structures, headwalls, footings & other data.</p>
Gage Chart																							
Gage	Dec. Inches																						
	Steel	Alum.																					
10	.138	.135																					
12	.109	.105																					
14	.079	.075																					
16	.064	.060																					

Culvert List

CULVERT LOCATIONS							DOWNSPOUT(d) or STANDPIPE(s) *4				AS BUILT			ROCK			REMARKS *6
DESIGNED *2														RIP RAP (GRADING)			
Road #	Sta./ M.P	SIZE	GAGE	LENGTH	CULVERT GRADE	INSTALL TYPE *3	SIZE	TYPE	LENGTH	TYPE OF ELBOW *5	SIZE	GAGE	LENGTH	(a) INLET	(b) OUTLET	Structure inside pipe	
5-7-10.0 (cont.)	0.361	36"	16	36'	--	--	--	--	--	--	--	--	--	--	--	--	Stream. Replace Existing Culvert as marked in field and directed by Authorized Officer (approx. 6' fill @ CL). Place 15 CY 1-1/2"-0" Crushed Bedding/Backfill Rock. Spread 15 CY 6" Jaw Run Base Rock over Pipe for Surfacing, capped with 10 CY 1-1/2"-0" Crushed Rock. Install metal inlet marker.
5-7-10.1 Joe White	0.196	36"	16	36'	--	--	--	--	--	--	--	--	--	--	--	--	Stream. Replace Existing Culvert as marked in field and directed by Authorized Officer (approx. 5' fill @ CL). Place 15 CY 1-1/2"-0" Crushed Bedding/Backfill Rock. Spread 15 CY 6" Jaw Run Base Rock over Pipe for Surfacing, capped with 10 CY 1-1/2"-0" Crushed Rock. Install metal inlet marker.
	0.423	24"	--	35'	--	--	--	--	--	--	--	--	--	--	--	--	Stream/Seeps. Replace Existing Culvert as marked in field and directed by Authorized Officer. Place 15 CY 1-1/2"-0" Crushed Bedding/Backfill Rock. Spread 15 CY 6" Jaw Run Base Rock over Pipe for Surfacing, capped with 10 CY 1-1/2"-0" Crushed Rock. Re-use existing metal inlet marker.
5-7-10.2 Canada Crk Rd	5+93	18"	--	40'	--	--	--	--	--	--	--	--	--	--	--	--	Install culvert as marked in field and directed by Authorized Officer. Place 20 CY 1-1/2"-0" Crushed Bedding/Backfill Rock. Spread 20 CY 6" Jaw Run Base Rock over Pipe for Surfacing, capped with 15 CY 1-1/2"-0" Crushed Rock. Excavate lead-off ditch (approx. 10 ft) from culvert outlet. Install metal inlet marker.
	7+23	--	--	--	--	--	--	--	--	--	--	--	--	--	--	--	Install metal inlet marker on existing CPP.
	8+63	--	--	--	--	--	--	--	--	--	--	--	--	--	--	--	Re-attach existing 10' half-round (needs hardware and stakes). Install existing inlet marker.
	9+68	--	--	--	--	--	--	--	--	--	--	--	--	5	--	--	Re-attach existing 10' half-round (needs hardware and stakes). Place 5 CY Pit-Run as backfill material. Place 5 CY Class 5 RipRap around outlet of existing CPP as stabilization wall to fix slope. Install metal inlet marker.
	25+00	24"	--	30'	--	--	--	--	--	--	--	--	--	5	--	--	Intermittent Stream. Replace Existing CMP as marked in field and directed by Authorized Officer (approx. 6' fill @ CL). Place 15 CY 1-1/2"-0" Crushed Bedding/Backfill Rock. Spread 10 CY 6" Jaw Run Base Rock over Pipe for Surfacing, capped with 10 CY 1-1/2"-0" Crushed Rock. Place 5 CY Class 5 RipRap @ outlet as stabilization wall/fill armor. Lower invert of outlet approx. 3 ft to stream bottom level. Re-use existing metal inlet marker.
	33+32	18"	--	35'	--	--	--	--	--	--	--	--	--	--	--	--	Install culvert as marked in field and directed by Authorized Officer. Place 15 CY 1-1/2"-0" Crushed Bedding/Backfill Rock. Spread 15 CY 6" Jaw Run Base Rock over Pipe for Surfacing, capped with 10 CY 1-1/2"-0" Crushed Rock. Install metal inlet marker.
	38+36	--	--	--	--	--	--	--	--	--	--	--	--	10	--	--	Cut approx. 4 ft off outlet end of pipe. Place 10 CY Class 5 RipRap @ outlet as dissipater/stabilization wall. Install metal inlet marker on existing CPP.
	40+85	--	--	--	--	--	--	--	--	--	--	--	--	--	--	--	Install metal inlet marker on existing CMP.
	44+47	24"	--	40'	--	--	--	--	--	--	--	--	--	5	--	--	Intermittent Stream. Replace Existing CMP as marked in field and directed by Authorized Officer (approx. 4' fill @ CL). Place 15 CY 1-1/2"-0" Crushed Bedding/Backfill Rock. Spread 15 CY 6" Jaw Run Base Rock over Pipe for Surfacing, capped with 10 CY 1-1/2"-0" Crushed Rock. Place 5 CY Class 5 RipRap @ outlet for stabilization wall/fill armor. Lower invert of outlet approx. 2 ft to stream bottom level. Re-use existing metal inlet marker.
	47+77	--	--	--	--	--	--	--	--	--	--	--	--	30	--	--	Stream. Place 20 CY Class 5 RipRap @ outlet of existing CMP as stabilization wall/fill armor. Place 10 CY Class 5 RipRap @ outlet as dissipater.
	55+30	--	--	--	--	--	--	--	--	--	--	--	--	--	--	--	Install metal inlet marker on existing CMP.
	58+81	24"	--	35'	--	--	--	--	--	--	--	--	--	--	--	--	Replace existing CMP as marked in field and directed by Authorized Officer. Place 15 CY 1-1/2"-0" Crushed Bedding/Backfill Rock. Spread 15 CY 6" Jaw Run Base Rock over Pipe for Surfacing, capped with 10 CY 1-1/2"-0" Crushed Rock. Install metal inlet marker.

Gage Chart		
Gage	Dec. Inches	
	Steel	Alum.
10	.138	.135
12	.109	.105
14	.079	.075
16	.064	.060

1. Designed culvert lengths and locations are approximate.

*2. all culverts have 2-2/3" x 1/2"

unless otherwise noted.

**** Corrugated plastic pipe (CPP), Type S (double wall) shall be used for culvert sizes 24" and smaller. All larger culverts shall be aluminized steel. All aluminized steel culverts are to have hugger type bands and neoprene gaskets. Culverts 20' in length or smaller shall be one piece (no joints). No Culvert piece shall be shorter than 6 foot. Minimization of banding is required.

*4. Downspout or Standpipe Types

- 1) Full
 - 2) Half
 - 3) Flume
- *** Downspouts and stand pipes (under 36" diameter) shall be CPP, Type C (single wall).

*5. 1) Conventional or Fabricated
2) Turner type
3) Slip joint

*6. Include special sections, structures, headwalls, footings & other data.

Culvert List

CULVERT LOCATIONS							DOWNSPOUT(d) or STANDPIPE(s) *4				AS BUILT			ROCK			REMARKS *6
DESIGNED *2														RIP RAP (GRADING)			
Road #	Sta./ M.P	SIZE	GAGE	LENGTH	CULVERT GRADE	INSTALL TYPE *3	SIZE	TYPE	LENGTH	TYPE OF ELBOW *5	SIZE	GAGE	LENGTH	(a) INLET	(b) OUTLET	Structure inside pipe	
5-7-10.2 Canada Crk Rd (cont.)	63+79	24"	--	30'	--	--	--	--	--	--	--	--	--	--	--	--	Intermittent Stream. Replace Existing CMP as marked in field and directed by Authorized Officer (approx. 4.5' fill @ CL). Place 15 CY 1-1/2"-0" Crushed Bedding/Backfill Rock. Spread 15 CY 6" Jaw Run Base Rock over Pipe for Surfacing, capped with 10 CY 1-1/2"-0" Crushed Rock. Install metal inlet marker.
	66+78	18"	--	30'	--	--	--	--	--	--	--	--	--	--	--	--	Install Culvert as marked in the field and directed by Authorized Officer. Place 10 CY 1-1/2"-0" Crushed Bedding/Backfill Rock. Spread 10 CY 6" Jaw Run Base Rock over Pipe for Surfacing, capped with 10 CY 1-1/2"-0" Crushed Rock. Excavate a lead-off ditch from culvert outlet (approx. 20ft). Install metal inlet marker.
	73+73	--	--	--	--	--	--	--	--	--	--	--	--	--	--	--	Repair dented inlet. Install metal inlet marker on existing CMP.
	86+89	24"	--	35'	--	--	--	--	--	--	--	--	--	--	--	--	Intermittent Stream/trench. Install culvert as marked in field and directed by Authorized Officer (approx. 4' fill @ CL). Place 15 CY 1-1/2"-0" Crushed Bedding/Backfill Rock. Spread 15 CY 6" Jaw Run Base Rock over Pipe for Surfacing, capped with 10 CY 1-1/2"-0" Crushed Rock. Install metal inlet marker.
	89+18	18"	--	30'	--	--	--	--	--	--	--	--	--	--	--	--	Install Culvert as marked in the field and directed by Authorized Officer. Place 10 CY 1-1/2"-0" Crushed Bedding/Backfill Rock. Spread 10 CY 6" Jaw Run Base Rock over Pipe for Surfacing, capped with 10 CY 1-1/2"-0" Crushed Rock. Install metal inlet marker.
	90+88	18"	--	30'	--	--	--	--	--	--	--	--	--	--	--	--	Install Culvert as marked in the field and directed by Authorized Officer. Place 10 CY 1-1/2"-0" Crushed Bedding/Backfill Rock. Spread 10 CY 6" Jaw Run Base Rock over Pipe for Surfacing, capped with 10 CY 1-1/2"-0" Crushed Rock. Install metal inlet marker.
	97+44	18"	--	30'	--	--	--	--	--	--	--	--	--	--	--	--	Install Culvert as marked in the field and directed by Authorized Officer. Place 10 CY 1-1/2"-0" Crushed Bedding/Backfill Rock. Spread 10 CY 6" Jaw Run Base Rock over Pipe for Surfacing, capped with 10 CY 1-1/2"-0" Crushed Rock. Install metal inlet marker.
	99+10	18"	--	30'	--	--	--	--	--	--	--	--	--	--	--	--	Install Culvert as marked in the field and directed by Authorized Officer. Place 10 CY 1-1/2"-0" Crushed Bedding/Backfill Rock. Spread 10 CY 6" Jaw Run Base Rock over Pipe for Surfacing, capped with 10 CY 1-1/2"-0" Crushed Rock. Excavate a lead-off ditch from culvert outlet (approx. 5 ft). Install metal inlet marker.
	100+94	18"	--	35'	--	--	--	--	--	--	--	--	--	--	--	--	Replace existing CMP as marked in field and directed by Authorized Officer (approx. 6' fill @ CL). Place 15 CY 1-1/2"-0" Crushed Bedding/Backfill Rock. Spread 15 CY 6" Jaw Run Base Rock over Pipe for Surfacing, capped with 10 CY 1-1/2"-0" Crushed Rock. Install metal inlet marker.
	102+90	36"	16	36'	--	--	--	--	--	--	--	--	--	--	--	--	Stream. Install culvert as marked in field and directed by Authorized Officer (approx. 5' fill @ CL). Place 20 CY 1-1/2"-0" Crushed Bedding/Backfill Rock. Spread 20 CY 6" Jaw Run Base Rock over Pipe for Surfacing, capped with 15 CY 1-1/2"-0" Crushed Rock. Install metal inlet marker.
	105+43	36"	16	46'	--	--	--	--	--	--	--	--	5	5	--	--	Stream/Pond. Replace existing CMP as marked in field and directed by Authorized Officer (approx. 7' fill @ CL). Place 20 CY 1-1/2"-0" Crushed Bedding/Backfill Rock. Spread 20 CY 6" Jaw Run Base Rock over Pipe for Surfacing, capped with 15 CY 1-1/2"-0" Crushed Rock. Place 5 CY Class 5 RipRap @ Inlet as fill armor. Place 5 CY Class 5 RipRap @ outlet as fill armor. Install metal inlet marker.
	109+07	36"	16	56'	--	--	--	--	--	--	--	--	10	30	--	--	Stream. Replace existing CMP as marked in field and directed by Authorized Officer (approx. 11' fill @ CL). Place 20 CY 1-1/2"-0" Crushed Bedding/Backfill Rock. Spread 20 CY 6" Jaw Run Base Rock over Pipe for Surfacing, capped with 15 CY 1-1/2"-0" Crushed Rock. Place 10 CY Class 5 RipRap @ Inlet as fill armor. Place 30 CY Class 5 RipRap @ outlet as Stabilization Wall/fill armor. Install metal inlet marker.
5-7-10.3 Broken Record Rd	0.027	18"	--	35'	--	--	18"	1	10'	--	--	--	--	--	--	--	Install Culvert and downspout as marked in the field and directed by Authorized Officer. Place 15 CY 1-1/2"-0" Crushed Bedding/Backfill Rock. Spread 15 CY 6" Jaw Run Base Rock over Pipe for Surfacing, capped with 10 CY 1-1/2"-0" Crushed Rock. Re-use metal inlet marker from MP 0.052.
	0.052	--	--	--	--	--	--	--	--	--	--	--	--	--	--	--	Remove existing CMP. Backfill trench with local suitable material. Surface with 10 CY 6"Jaw-Run capped with 10 CY1-1/2"-0" Crushed.
	0.155	18"	--	30'	--	--	18"	1	10'	--	--	--	--	--	--	--	Install Culvert and downspout as marked in the field and directed by Authorized Officer. Place 10 CY 1-1/2"-0" Crushed Bedding/Backfill Rock. Spread 10 CY 6" Jaw Run Base Rock over Pipe for Surfacing, capped with 10 CY 1-1/2"-0" Crushed Rock. Install metal inlet marker.
	0.275	18"	--	40'	--	--	--	--	--	--	--	--	--	--	--	--	Install Culvert as marked in the field and directed by Authorized Officer. Place 20 CY 1-1/2"-0" Crushed Bedding/Backfill Rock. Spread 20 CY 6" Jaw Run Base Rock over Pipe for Surfacing, capped with 15 CY 1-1/2"-0" Crushed Rock. Excavate lead-off ditch (approx. 10 ft) from culvert outlet. Install metal inlet marker.
	0.410	18"	--	30'	--	--	--	--	--	--	--	--	--	--	--	--	Install Culvert as marked in the field and directed by Authorized Officer. Place 10 CY 1-1/2"-0" Crushed Bedding/Backfill Rock. Spread 10 CY 6" Jaw Run Base Rock over Pipe for Surfacing, capped with 10 CY 1-1/2"-0" Crushed Rock. Excavate lead-off ditch (approx. 20 ft) from culvert outlet. Install metal inlet marker.
	0.500	18"	--	30'	--	--	--	--	--	--	--	--	--	--	--	--	Install Culvert as marked in the field and directed by Authorized Officer. Place 10 CY 1-1/2"-0" Crushed Bedding/Backfill Rock. Spread 10 CY 6" Jaw Run Base Rock over Pipe for Surfacing, capped with 10 CY 1-1/2"-0" Crushed Rock. Install metal inlet marker.
	0.588	18"	--	30'	--	--	--	--	--	--	--	--	--	--	--	--	Install Culvert as marked in the field and directed by Authorized Officer. Place 10 CY 1-1/2"-0" Crushed Bedding/Backfill Rock. Spread 10 CY 6" Jaw Run Base Rock over Pipe for Surfacing, capped with 10 CY 1-1/2"-0" Crushed Rock. Install metal inlet marker.
	0.975	18"	--	35'	--	--	--	--	--	--	--	--	--	--	--	--	Install Culvert as marked in the field and directed by Authorized Officer. Place 15 CY 1-1/2"-0" Crushed Bedding/Backfill Rock. Spread 15 CY 6" Jaw Run Base Rock over Pipe for Surfacing, capped with 10 CY 1-1/2"-0" Crushed Rock. Install metal inlet marker.

	<table border="1"> <thead> <tr> <th colspan="3">Gage Chart</th> </tr> <tr> <th rowspan="2">Gage</th> <th colspan="2">Dec. Inches</th> </tr> <tr> <th>Steel</th> <th>Alum.</th> </tr> </thead> <tbody> <tr> <td>10</td> <td>.138</td> <td>.135</td> </tr> <tr> <td>12</td> <td>.109</td> <td>.105</td> </tr> <tr> <td>14</td> <td>.079</td> <td>.075</td> </tr> <tr> <td>16</td> <td>.064</td> <td>.060</td> </tr> </tbody> </table>	Gage Chart			Gage	Dec. Inches		Steel	Alum.	10	.138	.135	12	.109	.105	14	.079	.075	16	.064	.060	<p>1. Designed culvert lengths and locations are approximate.</p> <p>*2. all culverts have 2-2/3" x 1/2" unless otherwise noted.</p> <p>**** Corrugated plastic pipe (CPP), Type S (double wall) shall be used for culvert sizes 24" and smaller. All larger culverts shall be aluminized steel. All aluminized steel culverts are to have hugger type bands and neoprene gaskets. Culverts 20' in length or smaller shall be one piece (no joints). No Culvert piece shall be shorter than 6 foot. Minimization of banding is required.</p>	<p>*4. Downspout or Standpipe Types</p> <p>1) Full 2) Half 3) Flume</p> <p>*** Downspouts and stand pipes (under 36" diameter) shall be CPP, Type C (single wall).</p>	<p>*5. 1) Conventional or Fabricated 2) Turner type 3) Slip joint</p> <p>*6. Include special sections, structures, headwalls, footings & other data.</p>
Gage Chart																								
Gage	Dec. Inches																							
	Steel	Alum.																						
10	.138	.135																						
12	.109	.105																						
14	.079	.075																						
16	.064	.060																						

U.S. DEPT. OF THE INTERIOR
Bureau of Land Management
NORTHWEST OREGON DISTRICT OFFICE - OREGON
CULVERT INSTALLATION DETAILS

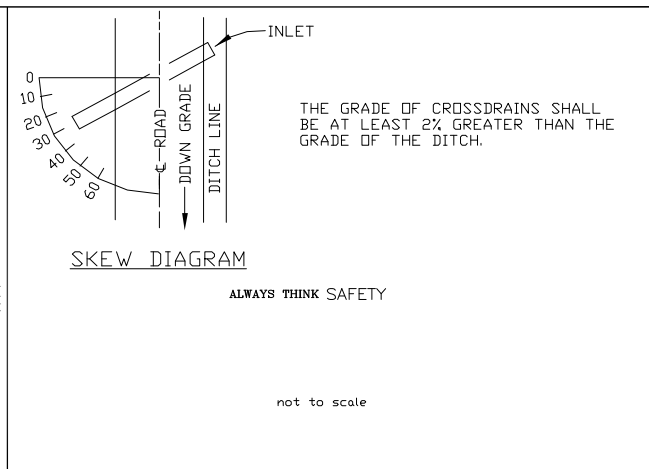
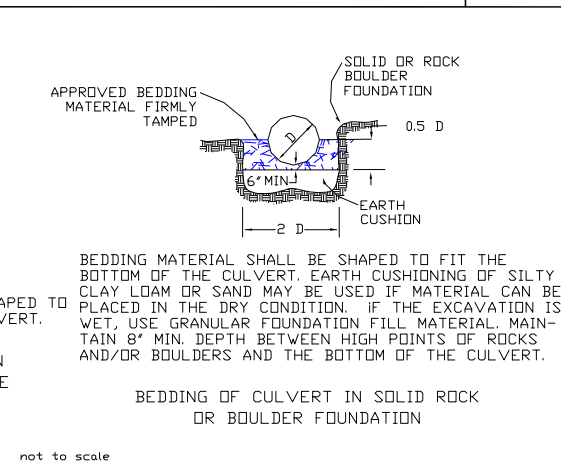
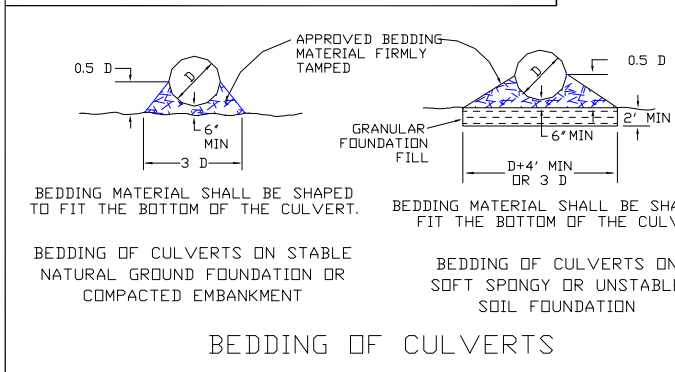
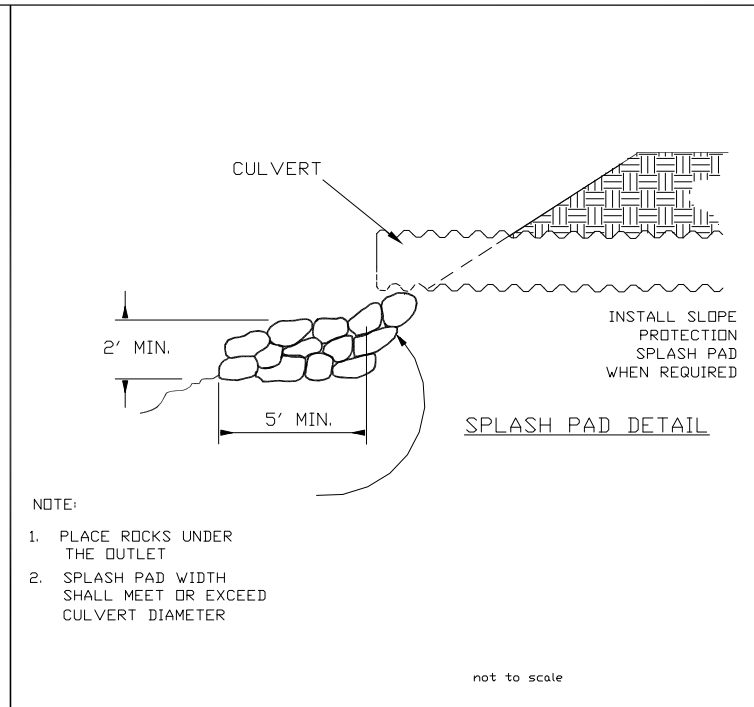
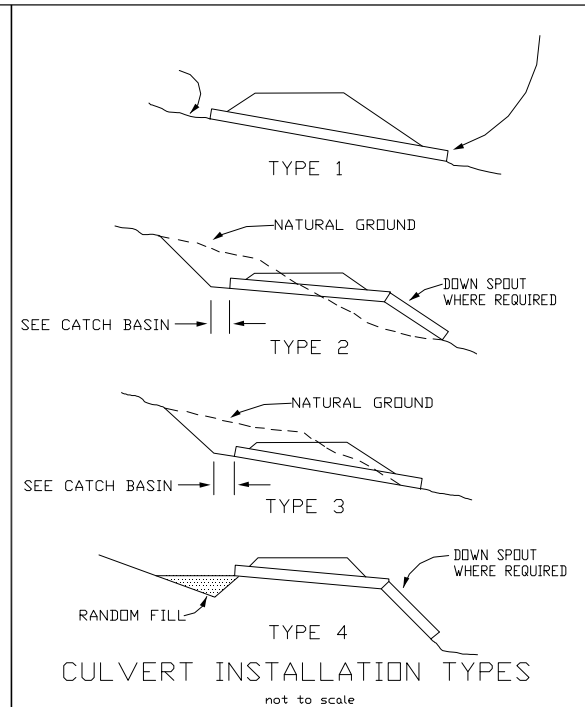
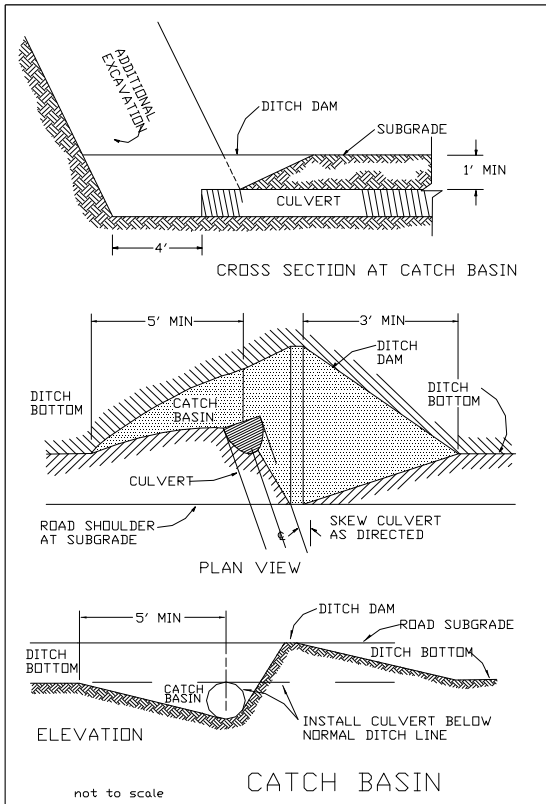

U.S. DEPT. OF THE INTERIOR
 Bureau of Land Management
 NORTHWEST OREGON DISTRICT OFFICE - OREGON
CULVERT BAND DETAILS

NOTE:
 DESIGN VARIATIONS IN FASTENERS,
 (STRAPS, BARS & WELDS) WHICH
 PROVIDE A TENSILE STRENGTH OF
 7500 LBS. ARE PERMISSIBLE.

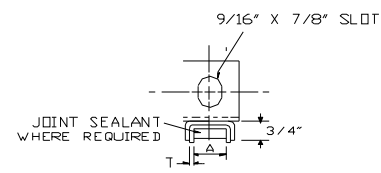
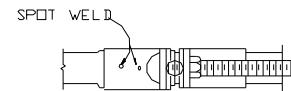
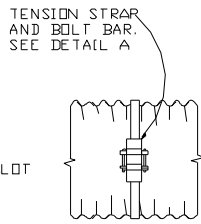
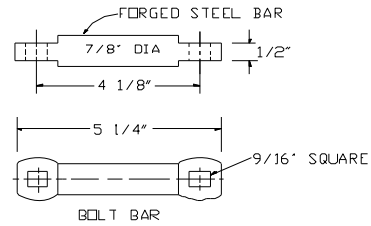
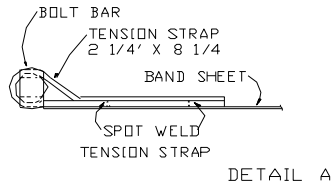

DIMENSIONS IN INCHES

T	A	PIPE WALL THICKNESS
.079	3/4	.109 OR LIGHTER
.109	1	.138 OR HEAVIER

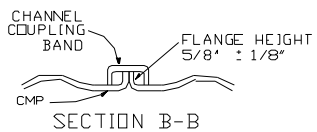
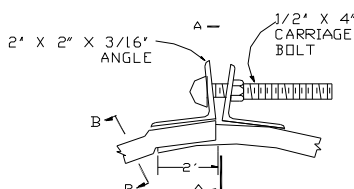

CHANNEL
 BAND
 COUPLER

NOTE:
 AS AN ALTERNATE TO SWEDGE, AN
 OVERSIZE BRIDGE CLIP MAY BE USED.

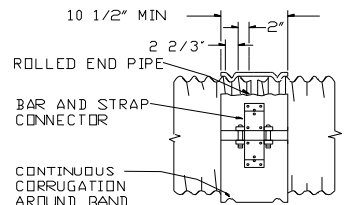

THE HUGGER COUPLER BAND OR AN APPROVED EQUIVALENT COUPLER BAND SHALL BE MADE OF THE SAME MATERIAL AND FINISH AS THE PIPES JOINED. THE COUPLER BANDS SHALL HAVE A MINIMUM WIDTH OF 10 1/2 INCHES AND MAY BE TWO NUMERICAL THICKNESSES LIGHTER THAN THE GAGE OR THICKNESS DESIGNATED FOR THE CONDUIT JOINED. THE BAND SHALL BE DESIGNED TO BE DRAWN TOGETHER WITH TWO 1/2 INCH BOLTS THROUGH USE OF A BAR AND STRAP SUITABLY WELDED TO THE BAND. THE BAND SHALL ENGAGE AND MESH WITH THE SECOND ANNULAR CORRUGATION INWARD FROM THE END OF EACH OF THE CONDUIT SECTIONS JOINED.

STANDARD CONSTRUCTION IS 1 PIECE 12\"/>

GASKETS AND "HUGGER" TYPE BANDS, OR AN APPROVED EQUIVALENT COUPLER, SHALL BE INSTALLED ON ALL 48\"/>

"HUGGER" COUPLER BANDS

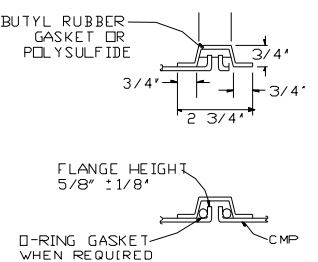
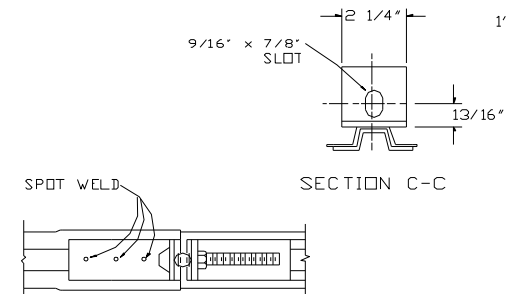

SECTION D-D
 SHOWN WITH ALTERNATE TYPES
 OF JOINT SEALERS

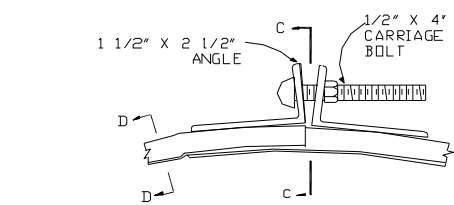

FLANGED END COUPLER

CULVERT SIZE (INCHES)	STANDARD COUPLER BANDS CORRUGATED							
	STD. ANNULAR		HELICAL		3' x 1'		6' x 1'	
	WIDTH	NO. OF BOLTS	WIDTH	NO. OF BOLTS	WIDTH	NO. OF BOLTS	WIDTH	NO. OF BOLTS
UNDER 18	7	2	7	2				
18 TO 54	12	3	12	3	14	3	18	3
OVER 54	24	5	24	5	24	5	24	4

DATA IN THIS BLOCK DOES NOT APPLY TO PERFORATED PIPE UNDERDRAIN. FOR BANDS WITH "PUNCH-OUT" TYPE CONNECTIONS, 2 BOLTS ARE PERMISSIBLE FOR EACH LAP. BANDS SHALL LAP 1/2 WIDTH ONTO EACH SECTION OF PIPE AND MUST FULLY ENIRCLE THE JOINT FORMING A NEARLY WATERTIGHT CONNECTION.

- Ⓐ BANDS WITH ANGLES
- Ⓑ BANDS WITH TENSION TYPE CONNECTIONS

ROCK VOLUMES TOTALS

ROAD SEGMENT: 4-7-21.0			MILEAGE: 0.000 - 0.833				
Application	Rock Size and Type	Location	Compacted Depth	Volume per Station/Item (CY)	Approx. Total (CY)	Curve Widening (CY)	Summary Totals
Road Rock	1-1/2"-0"	Cap Spot Rock	--	--	--	--	130
Culverts	1-1/2"-0"	Cap Spot Rock	--	--	--	--	20
Culverts	6" Jaw Run	Base Spot Rock	---	---	---	---	20
Culverts	1-1/2"-0"	Bedding/Backfill	---	---	---	---	20

ROAD SEGMENT: 4-7-28.2			MILEAGE: 0.000 - 0.774				
Application	Rock Size and Type	Location	Compacted Depth	Volume per Station/Item (CY)	Approx. Total (CY)	Curve Widening (CY)	Summary Totals
Road Rock	1-1/2"-0"	Cap Spot Rock	--	--	--	--	50
Energy Dissipater/outlet	RipRap: Class 3	MP 0.336	--	--	--	--	10

ROAD SEGMENT: 4-7-28.3			STATION: 0+00 - 21+08				
Application	Rock Size and Type	Location	Compacted Depth	Volume per Station/Item (CY)	Approx. Total (CY)	Curve Widening (CY)	Summary Totals
Road Rock	1-1/2"-0"	Cap Spot Rock	--	--	--	--	10
Road Rock	6" Jaw Run	Base Spot Rock	--	--	--	--	25
Culverts	1-1/2"-0"	Cap Spot Rock	---	---	---	---	40
Culverts	6" Jaw Run	Base Spot Rock	---	---	---	---	55
Culverts	1-1/2"-0"	Bedding/Backfill	---	---	---	---	55

ROAD SEGMENT: 4-7-33.2			STATION: 0+00 - 29+35				
Application	Rock Size and Type	Location	Compacted Depth	Volume per Station/Item (CY)	Approx. Total (CY)	Curve Widening (CY)	Summary Totals
Culverts	1-1/2"-0"	Cap Spot Rock	---	---	---	---	135
Culverts	6" Jaw Run	Base Spot Rock	---	---	---	---	175
Culverts	1-1/2"-0"	Bedding/Backfill	---	---	---	---	175
Stabilization Wall/Fill Armor/outlet	RipRap: Class 5	Sta. 24+16	--	--	--	--	25
Fill Armor/inlet	RipRap: Class 5	Sta. 24+16	--	--	--	--	5

ROAD SEGMENT: 5-7-3.1			STATION: 0+00 - 1+20				
Application	Rock Size and Type	Location	Compacted Depth	Volume per Station/Item (CY)	Approx. Total (CY)	Curve Widening (CY)	Summary Totals
Road Rock	1-1/2"-0"	Cap Spot Rock	--	--	--	--	40

ROAD SEGMENT: 5-7-8.1			MILEAGE: 0.000 - 0.901				
Application	Rock Size and Type	Location	Compacted Depth	Volume per Station/Item (CY)	Approx. Total (CY)	Curve Widening (CY)	Summary Totals
Road Rock	1-1/2"-0"	Cap Spot Rock	---	---	---	---	80
Culverts	1-1/2"-0"	Cap Spot Rock	---	---	---	---	120
Culverts	6" Jaw Run	Base Spot Rock	---	---	---	---	160
Culverts	1-1/2"-0"	Bedding/Backfill	---	---	---	---	160
Energy Dissipater/Fill Armor/outlet	RipRap: Class 3	MP 0.174	--	--	--	--	10

ROCK VOLUMES TOTALS

ROAD SEGMENT:			5-7-8.2		MILEAGE:			0.000 - 0.368	
Application	Rock Size and Type	Location/Number	Compacted Depth	Volume per Station/Item (CY)	Approx. Total (CY)	Curve Widening (CY)	Summary Totals		
Road Rock	1-1/2"-0"	Cap Spot Rock	---	---	---	---	130		
Road Rock	6" Jaw Run	Base Spot Rock	---	---	---	---	70		
Culverts	1-1/2"-0"	Cap Spot Rock	---	---	---	---	20		
Culverts	6" Jaw Run	Base Spot Rock	---	---	---	---	20		
Culverts	1-1/2"-0"	Bedding/Backfill	---	---	---	---	20		

ROAD SEGMENT:			5-7-8.6		STATION:			0+00 - 12+03	
Application	Rock Size and Type	Location	Compacted Depth	Volume per Station/Item (CY)	Approx. Total (CY)	Curve Widening (CY)	Summary Totals		
Road Rock	1-1/2"-0"	Cap Spot Rock	---	---	---	---	10		
Road Rock	6" Jaw Run	Base Spot Rock	---	---	---	---	20		
Culverts	1-1/2"-0"	Cap Spot Rock	---	---	---	---	10		
Culverts	6" Jaw Run	Base Spot Rock	---	---	---	---	10		
Culverts	1-1/2"-0"	Bedding/Backfill	---	---	---	---	10		

ROAD SEGMENT:			5-7-8.7		STATION:			0+00 - 17+23	
Application	Rock Size and Type	Location/Number	Compacted Depth	Volume per Station/Item (CY)	Approx. Total (CY)	Curve Widening (CY)	Summary Totals		
Culverts	1-1/2"-0"	Cap Spot Rock	---	---	---	---	25		
Culverts	6" Jaw Run	Base Spot Rock	---	---	---	---	30		
Culverts	1-1/2"-0"	Bedding/Backfill	---	---	---	---	30		

ROAD SEGMENT:			5-7-9.0 Coast Crk Rd		MILEAGE:			0.000 - 1.871	
Application	Rock Size and Type	Location/Number	Compacted Depth	Volume per Station/Item (CY)	Approx. Total (CY)	Curve Widening (CY)	Summary Totals		
Road Rock	1-1/2"-0"	Cap Spot Rock	---	---	---	---	170		
Culverts	1-1/2"-0"	Cap Spot Rock	---	---	---	---	130		
Culverts	6" Jaw Run	Base Spot Rock	---	---	---	---	175		
Culverts	1-1/2"-0"	Bedding/Backfill	---	---	---	---	210		
Culverts/inlet fill armor	Pit-Run	MP 0.951	---	---	---	---	20		
Culverts/outlet fill armor	Pit-Run	MP 0.951, 1.088	---	---	---	---	60		
Stabilization Wall/Fill Armor/outlet	RipRap: Class 5	MP 0.951, 1.088, 1.175, 1.702	--	--	--	--	130		

ROCK VOLUMES TOTALS

ROAD SEGMENT: 5-7-9.0 (cont.)			MILEAGE: 0.000 - 1.871				
Application	Rock Size and Type	Location	Compacted Depth	Volume per Station/Item (CY)	Approx. Total (CY)	Curve Widening (CY)	Summary Totals
Fill Armor/outlet	RipRap: Class 5	MP 0.415	--	--	--	--	25
Dissipater/outlet	RipRap: Class 5	MP 0.415, 1.388	---	---	---	---	15
Fill Armor/inlet	RipRap: Class 5	MP 0.415, 0.951, 1.088, 1.175	---	---	---	---	45

ROAD SEGMENT: 5-7-9.3			STATION: 0+00 - 21+23				
Application	Rock Size and Type	Location/Number	Compacted Depth	Volume per Station/Item (CY)	Approx. Total (CY)	Curve Widening (CY)	Summary Totals
Road Rock	1-1/2"-0"	Cap Spot Rock	---	---	---	---	160
Road Rock	6" Jaw Run	Base Spot Rock	---	---	---	---	145
Culverts	1-1/2"-0"	Cap Spot Rock	---	---	---	---	60
Culverts	6" Jaw Run	Base Spot Rock	---	---	---	---	75
Culverts	1-1/2"-0"	Bedding/Backfill	---	---	---	---	75
Stabilization Wall/Energy	RipRap: Class 5	Sta. 4+46	---	---	---	---	20

ROAD SEGMENT: 5-7-10.0 Burton Crk Rd			MILEAGE: 0.000 - 0.527				
Application	Rock Size and Type	Location	Compacted Depth	Volume per Station/Item (CY)	Approx. Total (CY)	Curve Widening (CY)	Summary Totals
Road Rock	1-1/2"-0"	Cap Spot Rock	---	---	---	---	35
Culverts	1-1/2"-0"	Cap Spot Rock	---	---	---	---	65
Culverts	6" Jaw Run	Base Spot Rock	---	---	---	---	105
Culverts	1-1/2"-0"	Bedding/Backfill	---	---	---	---	70
Ditchline Armor	Pit-Run	MP 0.014 - 0.052	---	---	---	---	10
Fill Armor/outlet	RipRap: Class 5	MP 0.237	---	---	---	---	5
Dissipater/outlet	RipRap: Class 5	MP 0.237	---	---	---	---	10

ROAD SEGMENT: 5-7-10.1 Joe White Rd			MILEAGE: 0.000 - 0.489				
Application	Rock Size and Type	Location	Compacted Depth	Volume per Station/Item (CY)	Approx. Total (CY)	Curve Widening (CY)	Summary Totals
Road Rock	1-1/2"-0"	Cap Spot Rock	---	---	---	---	30
Culverts	1-1/2"-0"	Cap Spot Rock	---	---	---	---	20
Culverts	6" Jaw Run	Base Spot Rock	---	---	---	---	30
Culverts	1-1/2"-0"	Bedding/Backfill	---	---	---	---	30
Ditchline Armor	Pit-Run	MP 0.423 - 0.431	---	---	---	---	10

ROAD SEGMENT: 5-7-10.2 Canada Crk Rd			STATION: 0+00 - 114+34				
Application	Rock Size and Type	Location	Compacted Depth	Volume per Station/Item (CY)	Approx. Total (CY)	Curve Widening (CY)	Summary Totals
Road Rock	1-1/2"-0"	Cap Spot Rock	---	---	---	---	120
Culverts	1-1/2"-0"	Cap Spot Rock	---	---	---	---	180

ROCK VOLUMES TOTALS

ROAD SEGMENT: 5-7-10.2 (cont.)			MILEAGE: 0.000 - 0.848				
Application	Rock Size and Type	Location	Compacted Depth	Volume per Station/Item (CY)	Approx. Total (CY)	Curve Widening (CY)	Summary Totals
Culverts	6" Jaw Run	Base Spot Rock	---	---	---	---	230
Culverts	1-1/2"-0"	Bedding/Backfill	---	---	---	---	235
Fill Material/outlet	Pit-Run	Sta. 9+68	---	---	---	---	5
Stabilization Wall/Fill Armor/outlet	RipRap: Class 5	Sta. 25+00, 44+47, 47+77, 109+07,	---	---	---	---	60
Fill Armor/outlet	RipRap: Class 5	Sta. 105+43	---	---	---	---	5
Stabilization Wall/Dissipater/outlet	RipRap: Class 5	Sta. 38+36	---	---	---	---	10
Stabilization Wall/outlet	RipRap: Class 5	Sta. 9+50, 9+68	---	---	---	---	10
Energy Dissipater/outlet	RipRap: Class 5	Sta. 47+77	---	---	---	---	10
Fill Armor/inlet	RipRap: Class 5	Sta. 105+43, 109+07	---	---	---	---	15

ROAD SEGMENT: 5-7-10.3 Broken Record Rd			MILEAGE: 0.000 - 1.266				
Application	Rock Size and Type	Location	Compacted Depth	Volume per Station/Item (CY)	Approx. Total (CY)	Curve Widening (CY)	Summary Totals
Road Rock	1-1/2"-0"	Cap Spot Rock	---	---	---	---	65
Road Rock	6" Jaw Run	Base Spot Rock	---	---	---	---	50
Culverts	1-1/2"-0"	Cap Spot Rock	---	---	---	---	85
Culverts	6" Jaw Run	Base Spot Rock	---	---	---	---	100
Culverts	1-1/2"-0"	Bedding/Backfill	---	---	---	---	90

ROAD SEGMENT: Coast Creek County Rd			MILEAGE: 0.000 - 1.199				
Application	Rock Size and Type	Location/Number	Compacted Depth	Volume per Station/Item (CY)	Approx. Total (CY)	Curve Widening (CY)	Summary Totals
Road Rock	1-1/2"-0"	Cap Spot Rock	---	---	---	---	100

ROAD MAINTENANCE SPECIFICATIONS

General road maintenance specifications are designated by numeric symbols according to the type of work performed as follows:

SECTION	DESCRIPTION
3000	General
3100	Operational Maintenance
3200	Seasonal Maintenance
3300	Final Maintenance
3400	Other Maintenance
3500	Decommissioning

GENERAL - 3000

- 3001 The Purchaser shall be required to maintain all roads as shown on the Exhibit E maps of this contract in accordance with Sections 3000, 3100, 3200, 3300, 3400, and 3500 of this exhibit.
- 3002 The Purchaser shall maintain the cross section of existing dirt or graveled roads to the existing geometric standards. Any roads required to be constructed, improved, or renovated under terms of this contract shall be maintained to the geometric standards required in Exhibit C of this contract.
- 3003 The minimum required maintenance on any Purchaser maintained roads shall include the provisions specified in Subsections 3101, 3104, and 3105.
- 3004 The Purchaser shall be responsible for providing timely maintenance and cleanup on any roads with logging units substantially completed prior to moving operations to other roads. The maximum length of non-maintained or non-cleanup of the road prism shall not exceed the sum of one (1) mile at any time. Release of maintenance requirements may be granted, upon written request, when the conditions specified in Sections 3300 and 3400 are met satisfactorily.

OPERATIONAL MAINTENANCE - 3100

- 3101 The Purchaser shall blade and shape the road surface and shoulders with a motor grader, when directed by the Authorized Officer. Banks shall not be undercut. Back blading with tractors or similar equipment will be allowed only around landings and other areas when approved by the Authorized Officer.
- 3102 The Purchaser shall furnish and place **870** cu.yds. of aggregate conforming to the requirements in Sections 1200 of Exhibit C of this contract on the roadway at locations and in the amounts designated by the Authorized Officer.
- 525** cu.yds. - To be placed on BLM controlled roads as directed by Authorized Officer (maintenance rock: Sections 42.v.).
- 345** cu yds – To be placed on non-BLM controlled roads as directed by the Authorized Officer (maintenance rock: Section 42.ee.)
- This aggregate shall be used to repair surface failures and areas of depleted surface depth excluding damages covered by Section 12 of this contract. The aggregate shall be furnished, hauled, placed, spread, and compacted by use of dump trucks, water trucks, and motor grader or similar equipment.

- 3104 The purchaser shall perform other road cleanup including removal of debris, fallen timber, bank slough, and slides which can practicably be accomplished by a motor grader, rubber tired front end bucket loader, rubber tired backhoe or comparable equipment, and by the use of hand tools.
- 3104a Removal of bank slough and slide material includes placement of material at the nearest designated, suitable disposal site where material cannot erode into streams, lakes, or reservoirs or cause undue damage to road fill slopes which have been planted or mulched to control soil erosion as directed by the Authorized Officer.
- 3104b The Purchaser shall be responsible for removal of all slides or slough, up to fifteen station yards in quantity, at any one site. This work includes unlimited multiple sites on all roads required to be maintained by the purchaser.
- Prior to removal of any slough or slide material exceeding fifteen station yards at any one site, the Purchaser and the Authorized Officer or their Authorized Representatives shall agree in writing, in the field, to the quantity of material, method of disposal, and the disposal site. Work may commence immediately after agreement.
- Upon completion of agreed upon work, a reduction in timber sale purchase price will be made to offset the cost of the work, based on current BLM Road Cost Guide. Adjustments in purchase price for completed work shall be made as necessary and no less than once per year when actual work is ongoing.
- 3105 The Purchaser shall be responsible for maintaining normal flow in drainage structures. This includes cleaning out drainage ditches, catch basins, clearing pipe inverts of sediment and other debris lodged in the barrel of the pipe, and maintaining water dips and waterbars using equipment specified in Subsection 3104 and other culvert cleaning and flushing equipment.
- 3108 The Purchaser shall avoid fouling gravel or bituminous surfaces through covering with earth and debris from side ditches, slides or other sources. The Purchaser shall also avoid blading surfacing material off the running surface of the roadway. (Skidding of logs on the roadway in or outside designated logging units is not authorized without prior written approval by the Authorized Officer. Repair required caused by such skidding activity is not considered maintenance and shall be repaired at the Purchaser's expense.)

SEASONAL MAINTENANCE - 3200

- 3201 The Purchaser shall perform preventative maintenance at the end of Purchaser's hauling each season and during non-hauling periods which occur between other

operations on the contract area. This includes requirements specified in Section 3100.

- 3202 The purchaser shall perform and complete maintenance specified in Sections 3000, 3100, and 3200 on all roads maintained by him, during times when there is a low potential to deliver sediment to streams, as determined by Authorized Officer, and as specified in Subsection 3203, after initial commencement of construction or logging operations. Thereafter, all roads shall have continuous preventive maintenance and road cleanup. This includes all roads used and not used during the preceding operating seasons.
- 3203 The Purchaser shall complete road cleanup and maintenance, as specified in Section 3100, at the completion of logging operations on any roads located in an area separate from the area where logging activities will resume.
- 3204 The Purchaser shall be responsible for performing post storm inspections and maintenance during the winter season to minimize erosion and potential road or watershed damage.

FINAL MAINTENANCE - 3300

- 3301 The Purchaser shall complete final maintenance and/or damage repairs on all roads used under terms of their contract within thirty (30) calendar days following the completion of hauling and in accordance with Sec. 16(b) of this contract. This work shall include any maintenance and/or damage repairs specified in Sections 3000, 3100, and 3200 necessary to meet the conditions specified in Subsection 3002 and shall be executed in accordance with Subsection 3302 of this section.

The Authorized Officer may grant acceptance of Purchaser's maintenance responsibility in part where certain individual roads or road segments are no longer of any use to the Purchaser's remaining removal operations, providing that all contract requirements as specified under Sec. 16(b), Special Provisions (Sections 3000, 3100, 3200 and 3300 of the maintenance specifications) have been completed and a relinquishment of cutting and removal rights on cutting units tributary to these roads is signed by the Purchaser. Request for partial acceptance must be submitted in writing by the Purchaser.

- 3302 The Purchaser shall perform final road maintenance only when weather or soil moisture conditions are suitable for normal maintenance equipment operations as determined by the Authorized Officer.

If final maintenance is delayed after the date required in Subsection 3301 of this contract by adverse soil moisture or unsuitable equipment operating conditions, the Purchaser will be notified by the Authorized Officer when soil moisture and equipment operating conditions are suitable. The Purchaser shall then be required to complete final maintenance within 30 days.

OTHER MAINTENANCE - 3400

- 3401 The Purchaser shall repair any damage to road surfaces that was specified under Subsection 3108. This repair includes restoring the roadway to the designed standard and replacement of surfacing with approved surface material. This repair is not limited to use of equipment specified in Subsection 3104.
- 3402 The Purchaser shall be permitted to remove ice and snow from roads authorized for use under this contract only when prior written approval has been secured from the Authorized Officer. The Purchaser shall submit a written request for permission to remove ice and snow in advance of the date operations are to begin.
- Upon receiving written authorization for ice or snow removal, the Purchaser will perform the work according to the conditions and equipment requirements set forth in the authorization.

DECOMMISSIONING – 3500

- 3501 Decommissioning on the following roads shall consist of removing cross drains and draw culverts. Work includes subsoiling, spread government supplied grass seed, installing non-drivable waterbars, scattering slash, hauling removed culverts to BLM facility, and blocking roads from access by vehicles. This work is *not* required for road acceptance under Section 18 of this contract.

Road No or Site	From Sta/MP	To Sta/MP	Length
4-7-28.3	1+00	21+08	2,008 feet
4-7-28.3a	0+00	1+15	115 feet
4-7-28.3b	0+00	1+61	161 feet
4-7-33.5	0+00	12+12	1,212 feet
4-7-33.6	0+00	0+98	98 feet
4-7-33.7	0+00	2+68	268 feet

- 3501d Stabilization of the following roads shall consist of installing drivable waterbars/waterdips (as directed). This work is *not* required for road acceptance under Section 18 of this contract.

Road No or Site	From Sta/MP	To Sta/MP	Length
4-7-33.2	0+00	29+35	2,935 feet
5-7-3.1	0+00	1+20	120 feet
5-7-8.6	0+00	12+03	1,203 feet

(Continued):			
Road No or Site	From Sta/MP	To Sta/MP	Length
5-7-8.7	0+00	17+23	1,723 feet
5-7-9.0	1.583	1.871	0.288 miles
5-7-9.3	8+56	21+23	1,267 feet
5-7-10.2	96+69	114+34	1,765 feet
5-7-10.3	1.050	1.266	0.216 miles

- 3504 Decommissioning and Stabilization work shall be completed after all harvesting activities requiring that road segment have ceased, unless otherwise authorized in writing by the Authorized Officer. All decommissioning and stabilization work shall be performed during times when there is a low potential to deliver sediment to streams, as determined by the Authorized Officer:
- 3505 Where draw crossing fill material is to be excavated and removed, the finished bottom of draw profile shall be reestablished to its original channel, grade, and resulting adjacent banks shall be constructed to a 2:1 backslope ratio.
- 3507 Culverts and Inlet Markers removed during decommissioning shall become the property of the BLM. All culverts and bands removed from the roadbed shall be recovered in such a manner as to preserve the pipe from rips and holes. The Purchaser shall be responsible for delivering culvert materials to the BLM Cedar Creek Storage Facility (SW¹/₄ sec. 5, T. 3 S., R. 6 W., WM.) and for payment of any fees required. This task shall be done prior to termination of this contract.
- 3509 Decommissioned roads shall have access blocked with barricades as shown on Exhibit C page 36. Stumps and woody debris used in the construction of barricades shall be material piled and stored during the clearing and grubbing process of road construction.
- 3511 Subsoiling shall be accomplished by using excavator attachments, log loader tongs, or other acceptable equipment capable of de-compacting the soil to a depth of 18 inches. The full width of the roadbed shall be loosened by the subsoiling operation, with no portion of the bed having been left at the original compacted density. Ripper entries into the roadbed shall be spaced where total subgrade subsoiling is accomplished.
- 3513 Waterbars (drivable and non-drivable)/Waterdips shall be installed across full width of roadway at locations marked in the field by Authorized Officer and constructed to the dimensions of the waterbar detail on Page 36 of Exhibit C.

United States Department of Interior
 BUREAU OF LAND MANAGEMENT
 NORTHWEST OREGON DISTRICT - OREGON
 Road Plan Map



T. 04S. R. 07W. Section 33 W.M. - NORTHWEST OREGON DISTRICT - OREGON
 T. 05S. R. 07W. Sections 03, 08, & 09 W.M. - NORTHWEST OREGON DISTRICT - OREGON

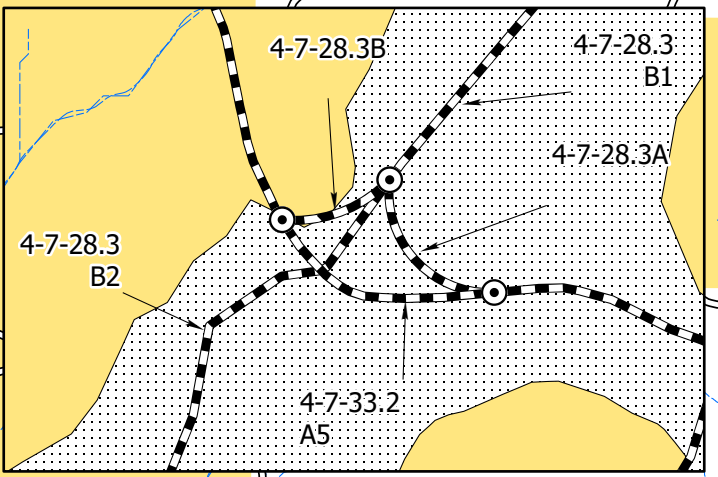
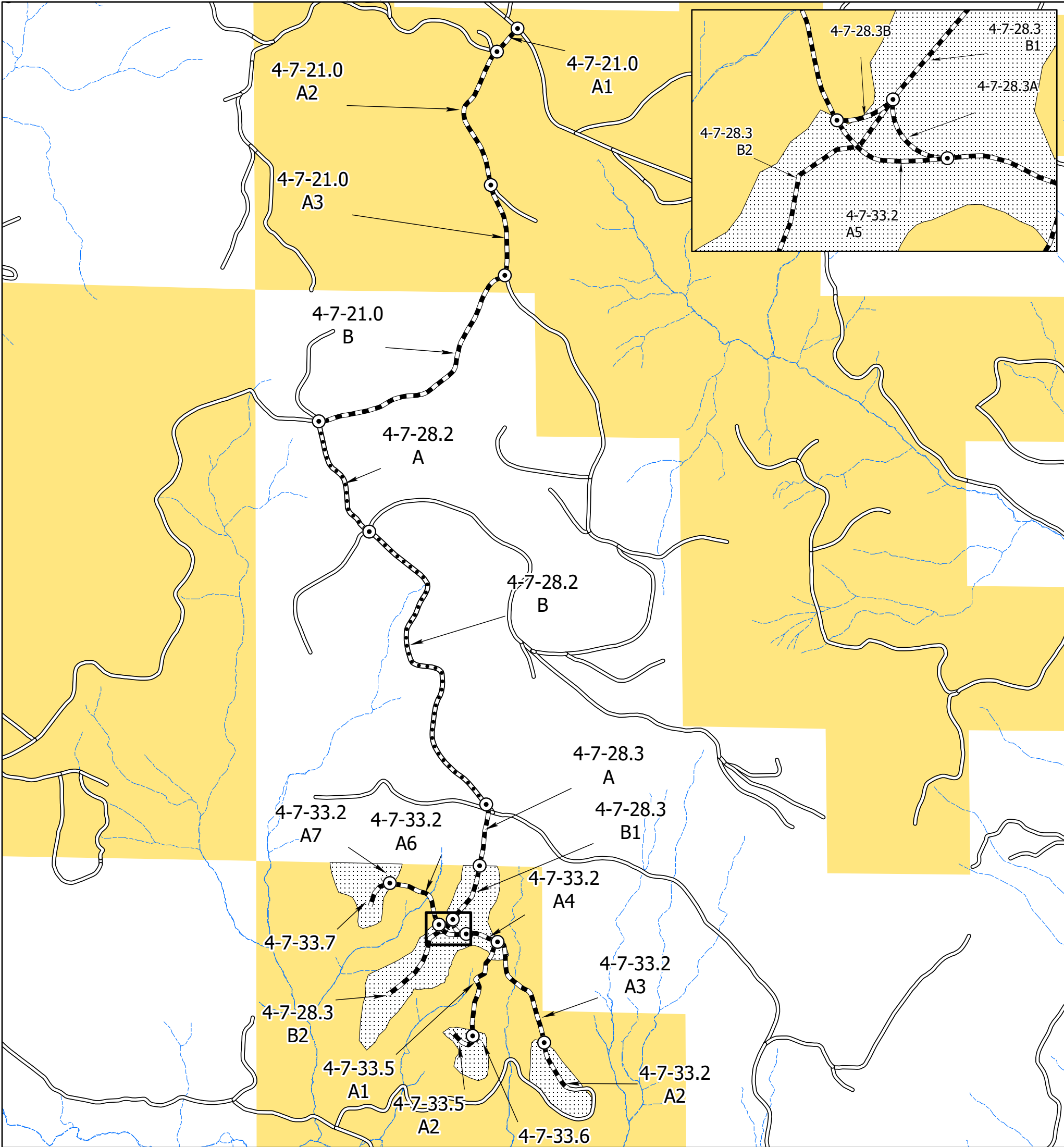

- ⊙ Segment Breaks
- BLM controlled road - Purchaser Maintenance
- Giustina controlled road - Purchaser Maintenance
- Existing Roads
- Streams
- ▨ Big Maple Project Area
- Bureau of Land Management

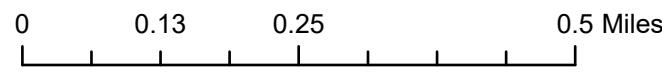

No warranty is made by the Bureau of Land Management as to the accuracy, reliability, or completeness of these data for individual or aggregate use with other data. Original data were compiled from various sources and may be updated without notification. Prepared By: Austin Bettis

United States Department of Interior
 BUREAU OF LAND MANAGEMENT
 NORTHWEST OREGON DISTRICT - OREGON
 Road Plan Map



T. 04S. R. 07W. Section 33 W.M. - NORTHWEST OREGON DISTRICT - OREGON
 T. 05S. R. 07W. Sections 03, 08, & 09 W.M. - NORTHWEST OREGON DISTRICT - OREGON

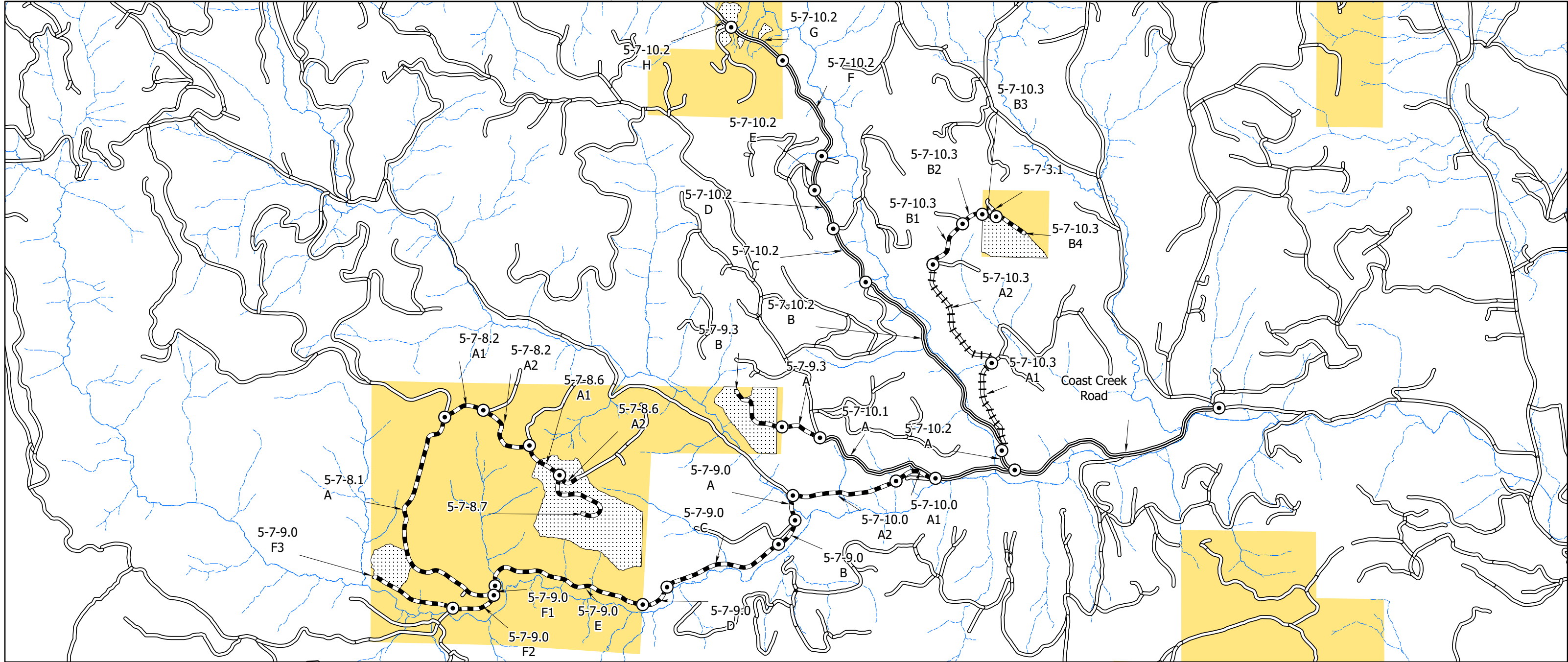

- ⊙ Segment Breaks
- Existing Roads
- ▬ BLM controlled road - Purchaser Maintenance
- ▬▬ County controlled road - Purchaser Maintenance
- ▬▬▬ Stimson controlled road - Purchaser Maintenance
- Streams
- ▨ Big Maple Project Area
- Bureau of Land Management

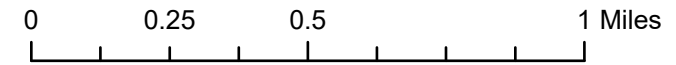

No warranty is made by the Bureau of Land Management as to the accuracy, reliability, or completeness of these data for individual or aggregate use with other data. Original data were compiled from various sources and may be updated without notification. Prepared By: Austin Bettis

United States Department of Interior
 BUREAU OF LAND MANAGEMENT
 NORTHWEST OREGON DISTRICT - OREGON
 Road Plan Map



T. 04S. R. 07W. Section 33 W.M. - NORTHWEST OREGON DISTRICT - OREGON
 T. 05S. R. 07W. Sections 03, 08, & 09 W.M. - NORTHWEST OREGON DISTRICT - OREGON

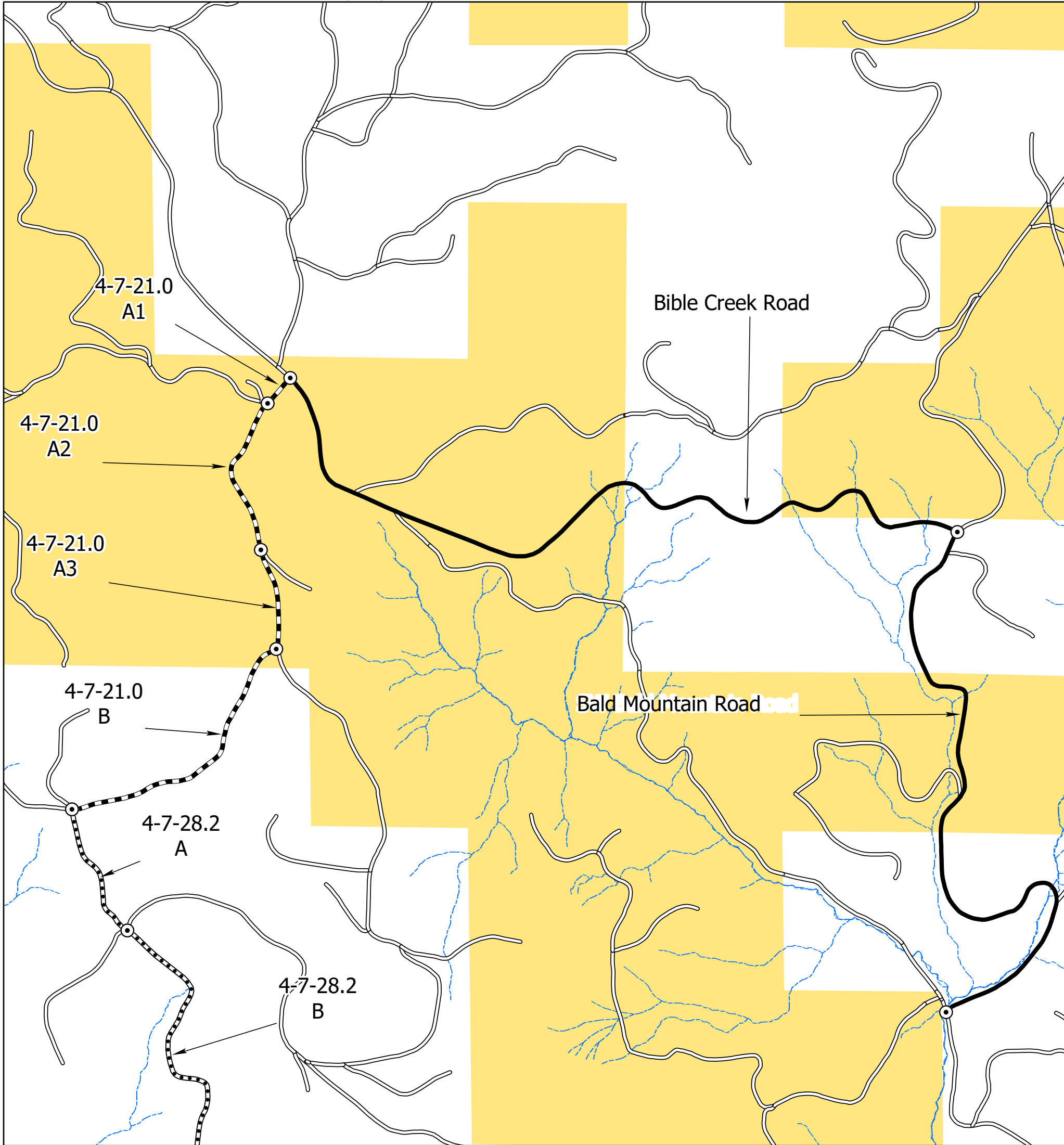

- ⊙ SegmentBreaks
- ▬ BLM controlled road - Purchaser Maintenance
- ▬ Giustina controlled road - Purchaser Maintenance
- ▬ BLM controlled road - BLM Maintenance -Designated Haul Route
- ▬ Existing Roads
- ▬ Streams
- ▬ Big Maple Project Area
- ▬ Bureau of Land Management

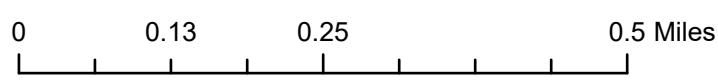

No warranty is made by the Bureau of Land Management as to the accuracy, reliability, or completeness of these data for individual or aggregate use with other data. Original data were compiled from various sources and may be updated without notification. Prepared By: Austin Bettis

COARSE WOODY DEBRIS (CWD) CREATION

The Purchaser shall select and treat a total of two hundred and five (205) reserve trees in the CWD Creation Units shown on Exhibit F maps (pages 9-14) to create Coarse Woody Debris (CWD) by saw-topping, high-girdling or basal-girdling. Treated trees will be marked with numbered aluminum tags and flagging. The Purchaser shall record the tree tag number, treatment type, tree data, and UTM coordinates for all treated trees on the Wildlife Tree Data Recording Forms (Illustration #4).

Treatment of trees to create CWD within any given unit shall not start until all yarding operations within that unit are complete. The Purchaser must provide a proposed schedule of work to the Authorized Officer at least one week prior to commencing the CWD creation activities.

CWD Creation per CWD Unit

CWD Unit Number ¹	CWD Unit Acres	Total Trees	Saw-Top	High Girdle	Basal Girdle	Snag Placement Description	Tree Size to be Selected (inches at DBH)
1	28	30	25	5	0	Dispersed = 10 HG and 15 ST. 5 HG in clump	24-35
2	15	61	31	0	30	Inner zone = 30 BG. Outer zone = 13 HG and 18 ST	15-22
3	16	16	12	4	0	Dispersed= 5 HG and 7 ST. 4 HG in clump	20-26
4A	16	16	13	3	0	Dispersed= 5 HG and 8 ST. 3 HG in clump	20-24
4B	8	8	5	3	0	Dispersed = 1HG and 4 ST. 3 HG in clump	10-15
5	63	63	53	10	0	Dispersed = 22 HG and 33 ST. 8 HG in clump	24-36
6	11	11	8	3	0	Dispersed = 2 HG and 6 ST. 3 HG on periphery of gap	10-15
Totals	157	205	147	28	30		

¹ See Coarse Woody Debris Creation maps (Exhibit F pages 9-14)

1. **Tree Selection** – The Purchaser shall select two hundred and five (205) reserve trees to create CWD by saw-topping, high-girdling or basal-girdling according to the following guidelines.

Numbers of trees and tree sizes to be selected, specific to each CWD unit, are displayed in the table above. Placement of trees to be selected by treatment type within the individual treatment units is displayed on the Coarse Woody Debris Creation maps (Exhibit F pages 11-14). The locations of the selected trees (individually or in small groups; distance from roads or property line) varies by treatment method; see treatment methods below for additional treatment-specific information concerning tree selection.

- Only healthy Douglas-fir trees shall be selected for treatment.
 - No trees marked with any existing metal tags shall be selected for treatment.
 - No trees with nests or any nest-like structures of any birds or mammals, or trees with defects such as cavities, platforms, mistletoe infection, or dead, forked/multiple and/or broken tops shall be selected.
 - Selected trees shall be evenly distributed throughout the CWD units. When selecting trees, select approximately fifty (50) percent of the trees larger than the median tree size for the given range, and approximately fifty (50) percent of the trees smaller than the median tree size for the given range unless stand conditions dictate otherwise. If only trees smaller than the appropriate size are available, select trees of the largest size class present. Do not select the largest, most dominant tree within any given area.
- a. **Saw-topping and High-girdling:** Select healthy appearing Douglas-fir trees with live crown ratios greater than thirty (30) percent and with **average or larger** crown spread. If only trees with smaller live crown ratios than appropriate are available, select trees with the largest crown ratio present. Treatment types and selected trees shall be scattered uniformly throughout the units. Trees selected for saw-topping shall be selected singly or in small groups of three (3) to five (5) trees. Trees selected for high-girdling shall be selected in groups of three (3) to five (5) trees. Trees selected for saw-topping or high-girdling shall not be located within one hundred (100) feet of a drivable road (open after use) or within 75 feet of a property line boundary where BLM land abuts non-federal ownership (Exhibit F pages 9-14).
- b. **Basal-girdling:** Select healthy Douglas-fir trees with live crown ratios **less** than thirty (30) percent and **smaller** than average crown spread. If only trees with larger live crown ratios than appropriate are available, select appropriately sized trees with the smallest crown ratio present. Selected trees shall be located within the portion of the CWD units designated for basal-girdling and selected in groups of three (3) to five (5) trees. Trees selected for basal-girdling shall not be located within approximately one hundred fifty (150) feet of a drivable road (open after use) or a property line boundary where BLM land abuts non-federal ownership (Exhibit F pages 9-14). Trees selected for basal-girdling shall be those trees which provide minimal amounts or no shade to streams (e.g., north side of stream channel and/or being an area where topography or tree location minimizes the shade afforded to stream by selected tree, such as being located several tree spacings from the stream channel).

2. **CWD Treatments**

a. **Saw-Topping** – severing the treetop within the live crown

1. The Purchaser shall climb and top selected trees at a height of at least sixty (60) feet above the ground at a point where approximately twenty to fifty (20-50) percent of the live crown remains; saw-topping heights shall be varied equally within this placement within the live crown (See Illustration 1). Topping shall be done with power tools (e.g., chainsaws).
2. The Purchaser shall cut several V-type notches that are a minimum of six (6) cuts into the sawn top surface of the tree, each a minimum of six (6) inches deep.
3. To the extent practicable, the Purchaser shall retain all green limbs and the largest dead limbs on the treated trees during the climbing and topping operations.
4. Tree tops shall be completely severed from the tree and fall completely to the ground inside unit boundaries.
5. To the extent practicable, the Purchaser shall directionally fall tops in order to not damage existing snags, under-story conifers, any tree containing a suspected nest of a bird or mammal, or any tree with defects such as hollow cavities, multiple tops, or decay, and avoid to contact with unburned burn piles and drivable roads.
6. The Purchaser shall tie two (2) pieces of flagging of a color approved by the Authorized Officer around the bole of each treated tree, one (1) at a height of approximately twenty to thirty (20-30) feet above the ground and another at four and one-half (4.5) feet above the ground (measured from the uphill side of the tree).
7. A small numbered aluminum tag shall be nailed to the base of the treated tree (uphill side). The tree tag number shall be recorded on the Wildlife Tree Data Recording Form.

b. **High-Girdling** – girdling within the live crown

1. The Purchaser shall climb and girdle selected trees within the live crown at a point where approximately twenty to fifty (20-50) percent of the live crown remains below the point of girdling and at a height of at least sixty (60) feet above the ground; girdling heights shall be varied equally within this placement within the live crown. Girdling may be done with a hand tool or power tool and will consist of removing all bark and cambium in a ten to twelve (10-12) inch band completely around the main stem of the tree. (See Illustration #3)
2. Tool cuts must not penetrate more than one-half (0.5) inches into the wood of high-girdled trees.
3. Live limbs below the point of high-girdling shall not be removed. To the extent practicable, the Purchaser shall retain the largest dead limbs on the trees during the climbing and high-girdling operations.

4. The Purchaser shall tie three pieces of flagging of a color approved by the Authorized Officer to each high-girdled tree. One flag shall be tied on a branch visible from the ground near the point of girdle, a second flag shall be tied around the bole of the tree at a height of approximately twenty to thirty (20-30) feet above the ground and a third flag at four and one-half (4.5) feet above the ground (measured from the uphill side of the tree). The two highest flags shall extend at least four (4) feet from the knot.
5. A small numbered aluminum tag shall be nailed to the base of the treated tree (uphill side). The tree tag number shall be recorded on the Wildlife Tree Data Recording Form.

c. Basal-Girdling

1. The Purchaser shall basal-girdle selected trees by making three (3) parallel cuts around the bole of the tree between three (3) and four (4) feet above ground level measured on the uphill side of the tree; power tools may be used. Each cut must connect with itself completely around the tree and penetrate through the cambium layer into the wood at least one-half (0.5) inches, but not more than one and one-half (1.5) inches. The distance between the top cut and the bottom cut shall not exceed twelve (12) inches. (See Illustration #2)
2. The Purchaser shall tie a piece of flagging of a color approved by the Authorized Officer around the bole of each treated tree four and one-half (4.5) feet above the ground (measured from the uphill side of the tree).
3. A small numbered aluminum tag shall be nailed to the base of the treated tree (uphill side). The tree tag number shall be recorded on the Wildlife Tree Data Recording Form.

3. Documentation

- d. The Purchaser shall provide the location for all saw-topped, high-girdled, basal-girdled or felled trees by documenting the UTM coordinates using a GPS unit with NAD83 datum, zone 10. If acceptable GPS satellite coverage cannot be obtained at a site, the point shall be hand drawn onto a map and submitted to the Authorized Officer with the Wildlife Tree Data Recording Forms.
- e. The Purchaser shall provide the Wildlife Tree Data Recording Forms, UTM coordinates, and any hand drawn maps in a digital format once per week to the Authorized Officer for work completed during the previous week.
- f. All information recorded on the Wildlife Tree Data Recording Forms shall be legible, clear and reproducible on a black and white copy machine. All documents shall be reviewed by the Purchaser to ensure completeness, legibility, accuracy, and consistency in style before submitting them to the Authorized Officer.

ILLUSTRATION #1 – Saw-topping within the Live Crown

Cut a V-type notch or a “King’s Crown” (with a minimum of 6 cuts) into the sawn top surface, a minimum of 6 inches deep, to provide for a greater potential of future decay in the treetop. To the extent practicable, retain all green limbs and the largest dead limbs on the treated trees during the climbing and topping operation.

The tree shall be topped at a height of at least 60 feet above the ground at a point where approximately 20% to 50% of the live crown remains. Topping heights shall be varied equally within this placement within the live crown.

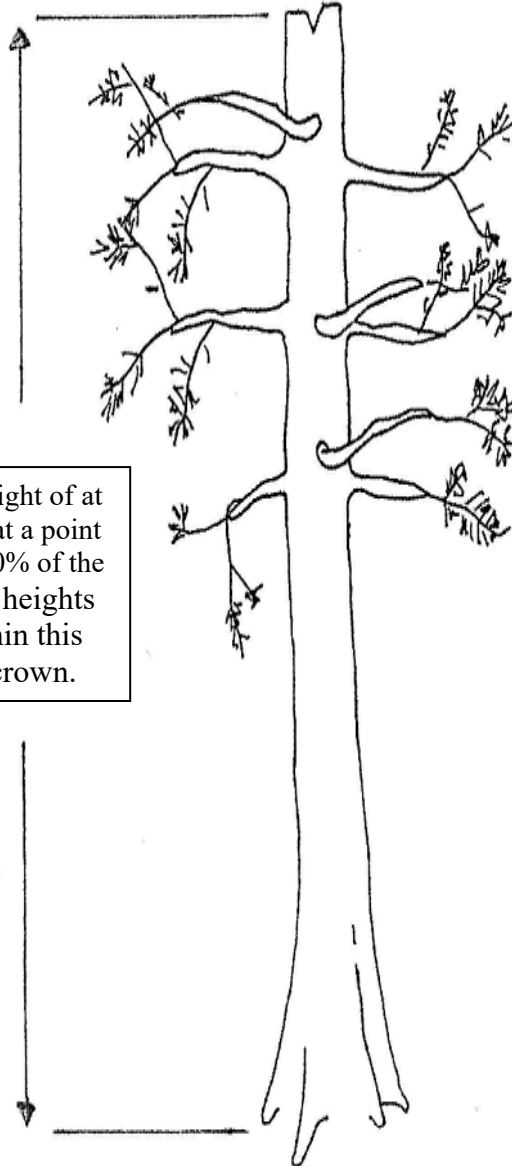

Tie two pieces of flagging around the bole of each saw-topped tree, one at a height of approximately 20-30 feet and one 4.5 feet above the ground. A small numbered aluminum tag shall be nailed to the base of the tree (uphill side).

Basal-Girdling ILLUSTRATION #2

Girdling example: make three (3) parallel unbroken cuts around the tree. The distance between the top and the bottom of the cut shall not exceed twelve inches. Cuts must penetrate at least $\frac{1}{2}$ inch, but not more than $1\frac{1}{2}$ inches into the wood of the tree. Trees shall be girdled between 3 and 4 feet from the ground.

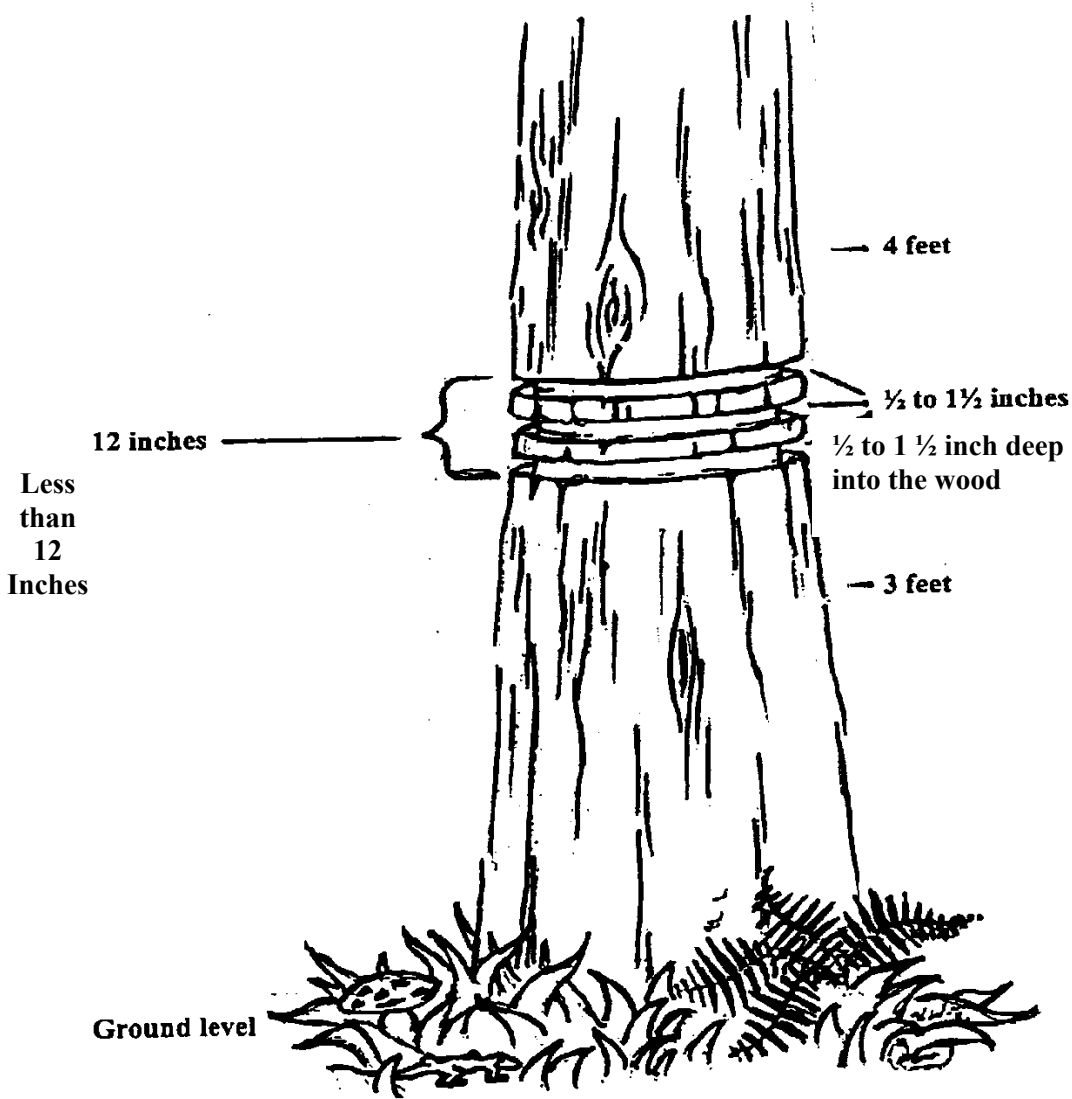

Tie one piece of flagging around the bole of each basal-girdled tree 4.5 feet above the ground. A small numbered aluminum tag shall be nailed to the base of the tree (up-hill side).

Illustration #3 – High-Girdling within the Live Crown

Crown Girdling Specifications:

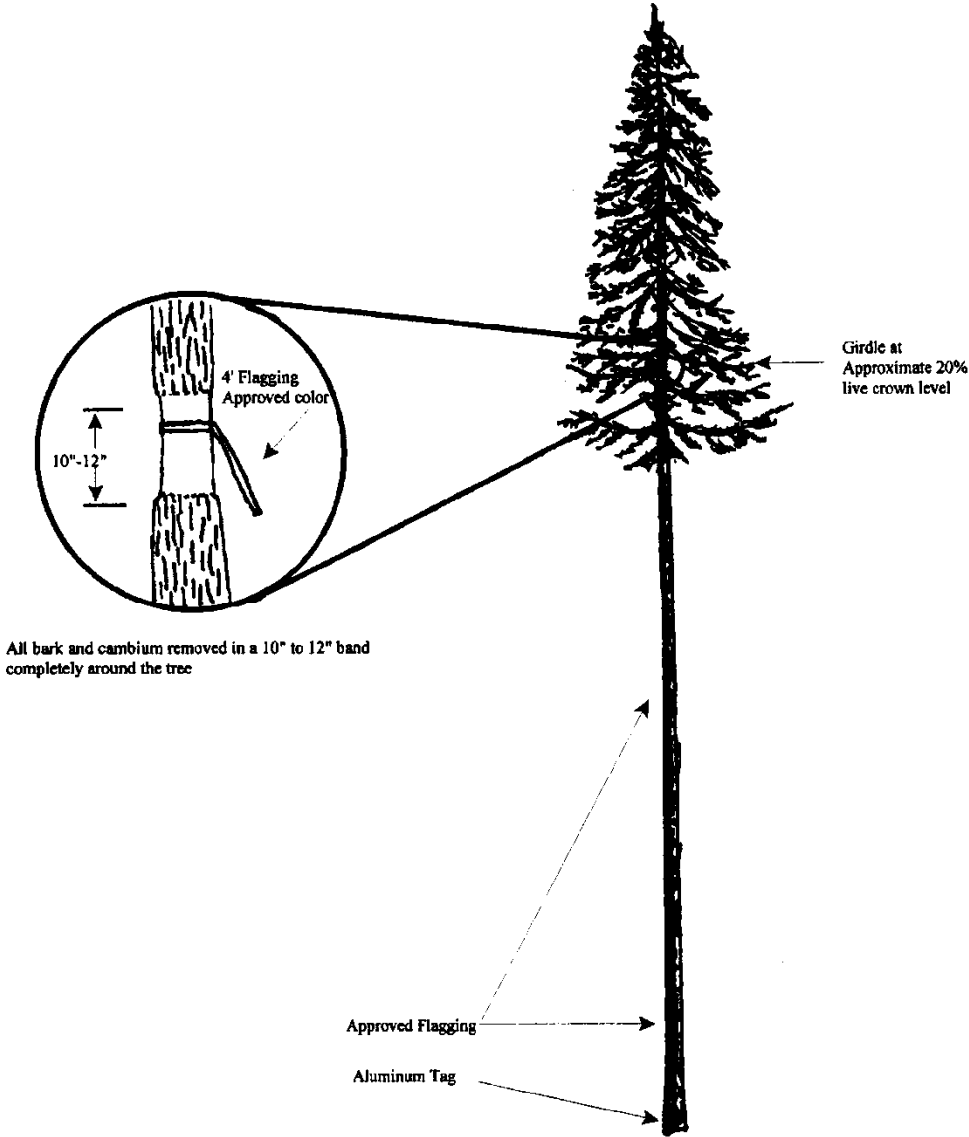

To the extent practicable, retain all green limbs and the largest dead limbs on the treated trees below the point of treatment. Treatment heights shall be greater than or equal to 60 feet above the ground at a point in the live crown where 20% to 50% of live branches remain. Girdling heights shall be varied equally within this placement within the live crown. Tie three pieces of flagging around the bole of each high-girdled tree, one at the point of girdling, one at a height of approximately 20-30 feet and one 4.5 feet above the ground. A small numbered aluminum tag shall be nailed to the base of the tree (uphill side).

Big Maple Timbersale
Coarse Woody Debris Creation

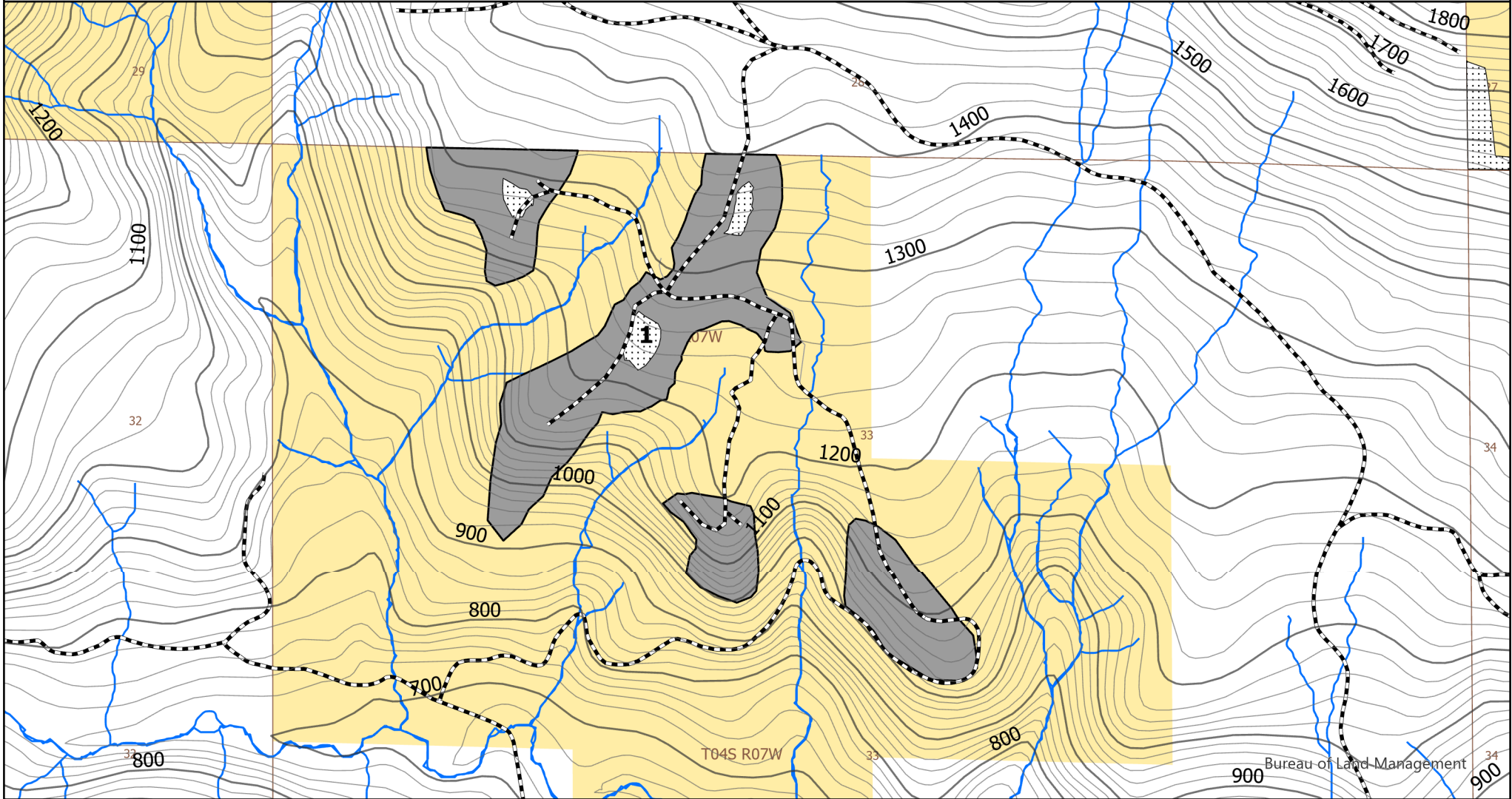

- CWD Units
- Clump
- Bureau of Land Management

CWD Unit Number	CWD Unit Acres	Total Trees	Saw-Top (ST)	High Girdle (HG)	Basal Girdle (BG)	Tree Size to be Selected (inches at DBH)	Notes
1	28	30	25	5	0	24-35	Dispersed = 25 ST, 5 HG in clump



No warranty is made by the Bureau of Land Management as to the accuracy, reliability, or completeness of these data for individual or aggregate use with other data. Original data were compiled from various sources and may be updated without notification.

Big Maple Timbersale
Coarse Woody Debris Creation

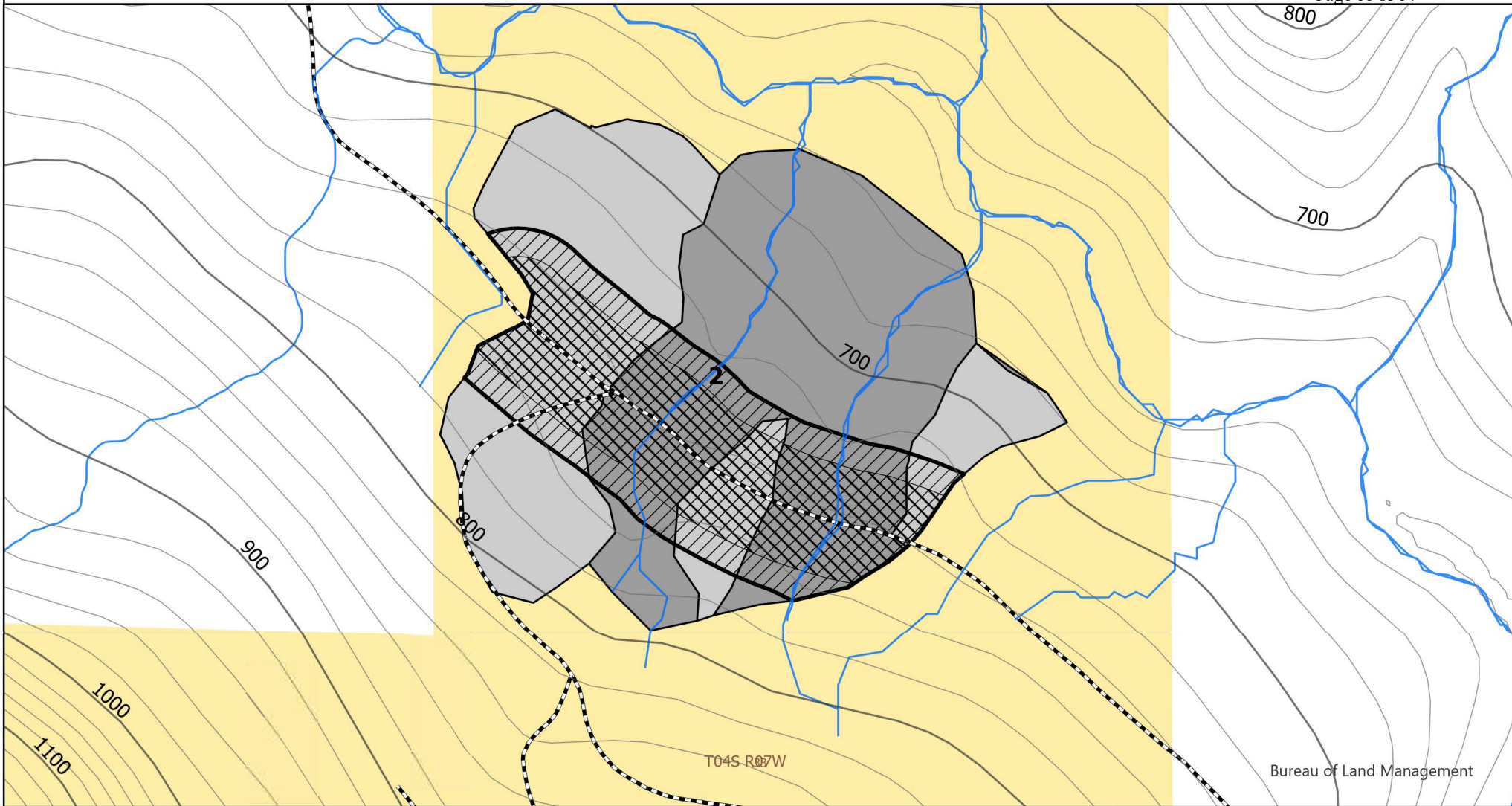

- Inner zone CWD unit
- Outer zone CWD unit
- Clump
- No Basal Girdle
- No Top Girdle or Saw Top
- Bureau of Land Management

CWD Unit Number	CWD Unit Acres	Total Trees	Saw-Top (ST)	High Girdle (HG)	Basal Girdle (BG)	Tree Size to be Selected (inches at DBH)	Notes
2	15	61	31	0	30	15-22	Inner zone = 30 BG. Outer zone = 31 ST



No warranty is made by the Bureau of Land Management as to the accuracy, reliability, or completeness of these data for individual or aggregate use with other data. Original data were compiled from various sources and may be updated without notification.

Big Maple Timbersale
Coarse Woody Debris Creation

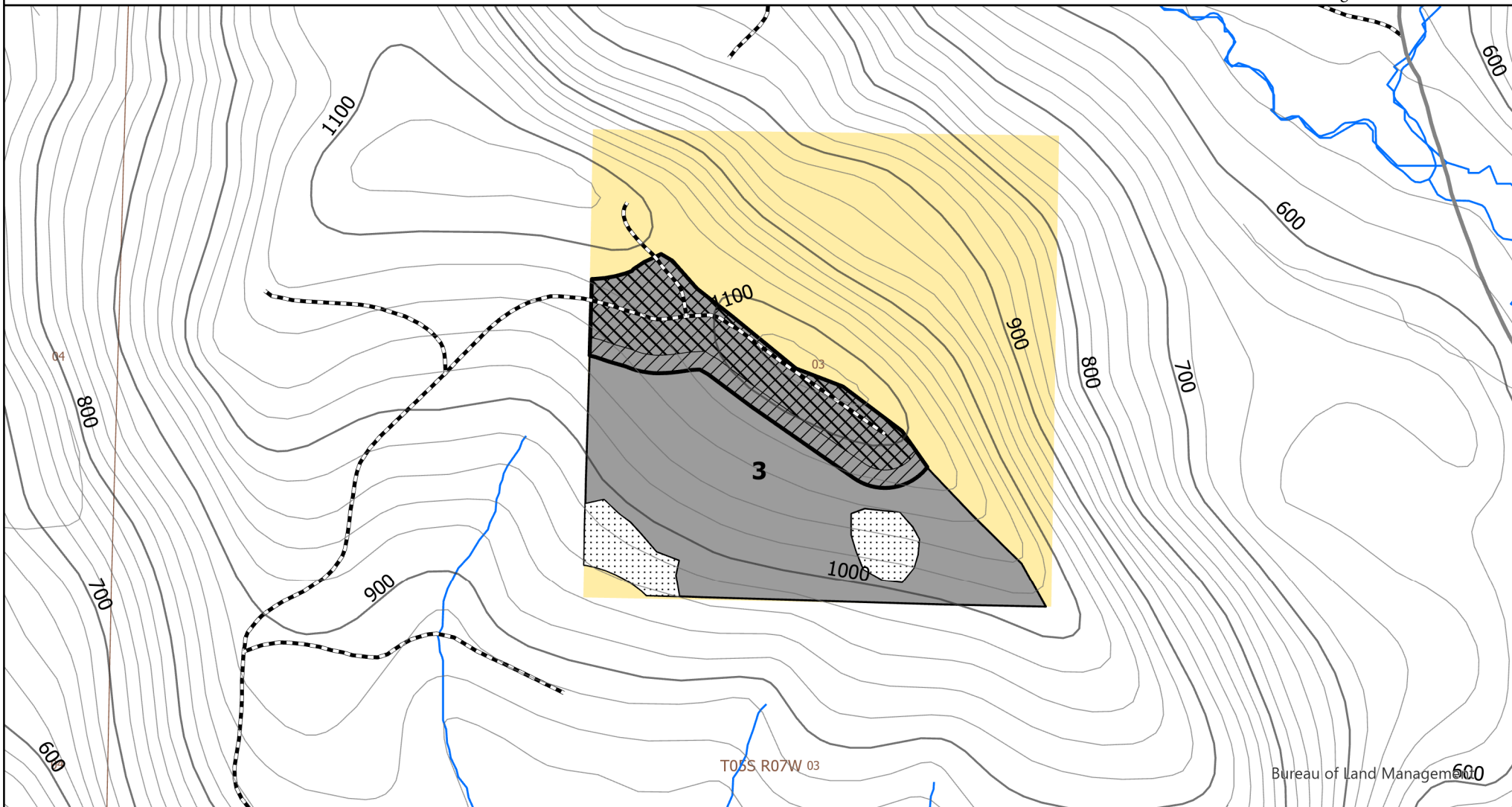

- CWD Units
- Clump
- No Basal Girdle
- No Top Girdle or Saw Top
- Bureau of Land Management

CWD Unit Number	CWD Unit Acres	Total Trees	Saw-Top (ST)	High Girdle (HG)	Basal Girdle (BG)	Tree Size to be Selected (inches at DBH)	Notes
3	16	16	12	4	0	20-26	Dispersed= 12 ST, 4 HG in clump

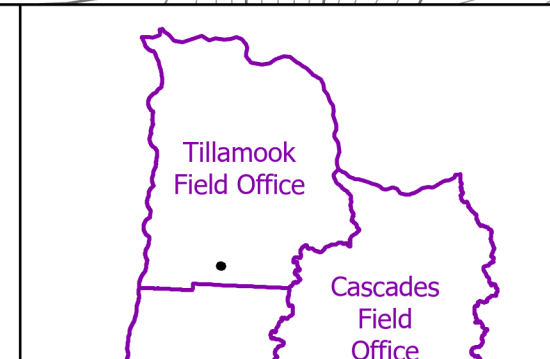

No warranty is made by the Bureau of Land Management as to the accuracy, reliability, or completeness of these data for individual or aggregate use with other data. Original data were compiled from various sources and may be updated without notification.

Big Maple Timbersale
Coarse Woody Debris Creation

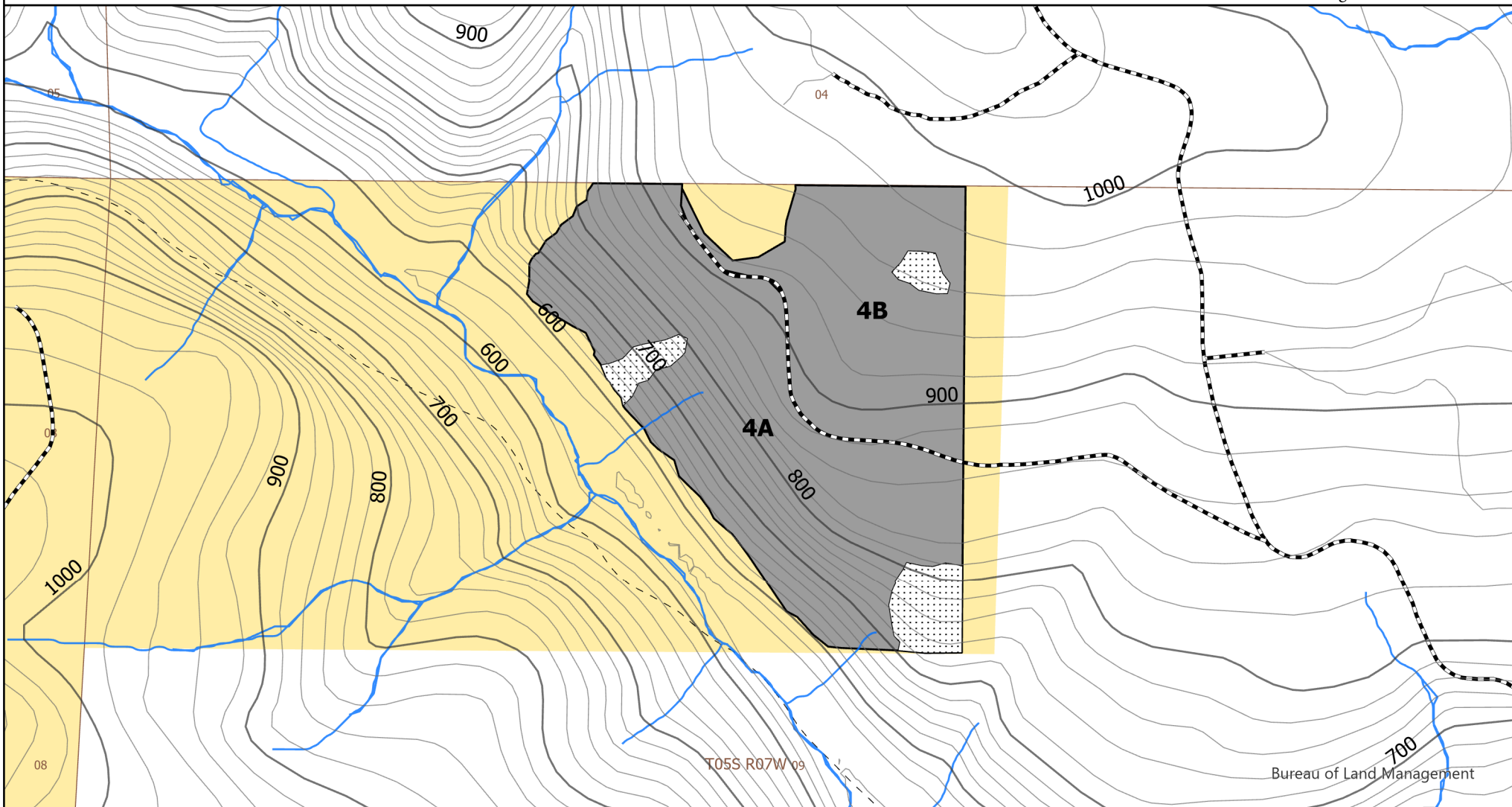

- CWD Units
- Clump
- Bureau of Land Management

CWD Unit Number	CWD Unit Acres	Total Trees	Saw-Top (ST)	High Girdle (HG)	Basal Girdle (BG)	Tree Size to be Selected (inches at DBH)	Notes
4A	16	16	13	3	0	20-24	Dispersed= 13 ST. 3 HG in clump
4B	8	8	5	3	0	10-15	Dispersed = 5 ST. 3 HG in clump



No warranty is made by the Bureau of Land Management as to the accuracy, reliability, or completeness of these data for individual or aggregate use with other data. Original data were compiled from various sources and may be updated without notification.

Big Maple Timbersale
Coarse Woody Debris Creation

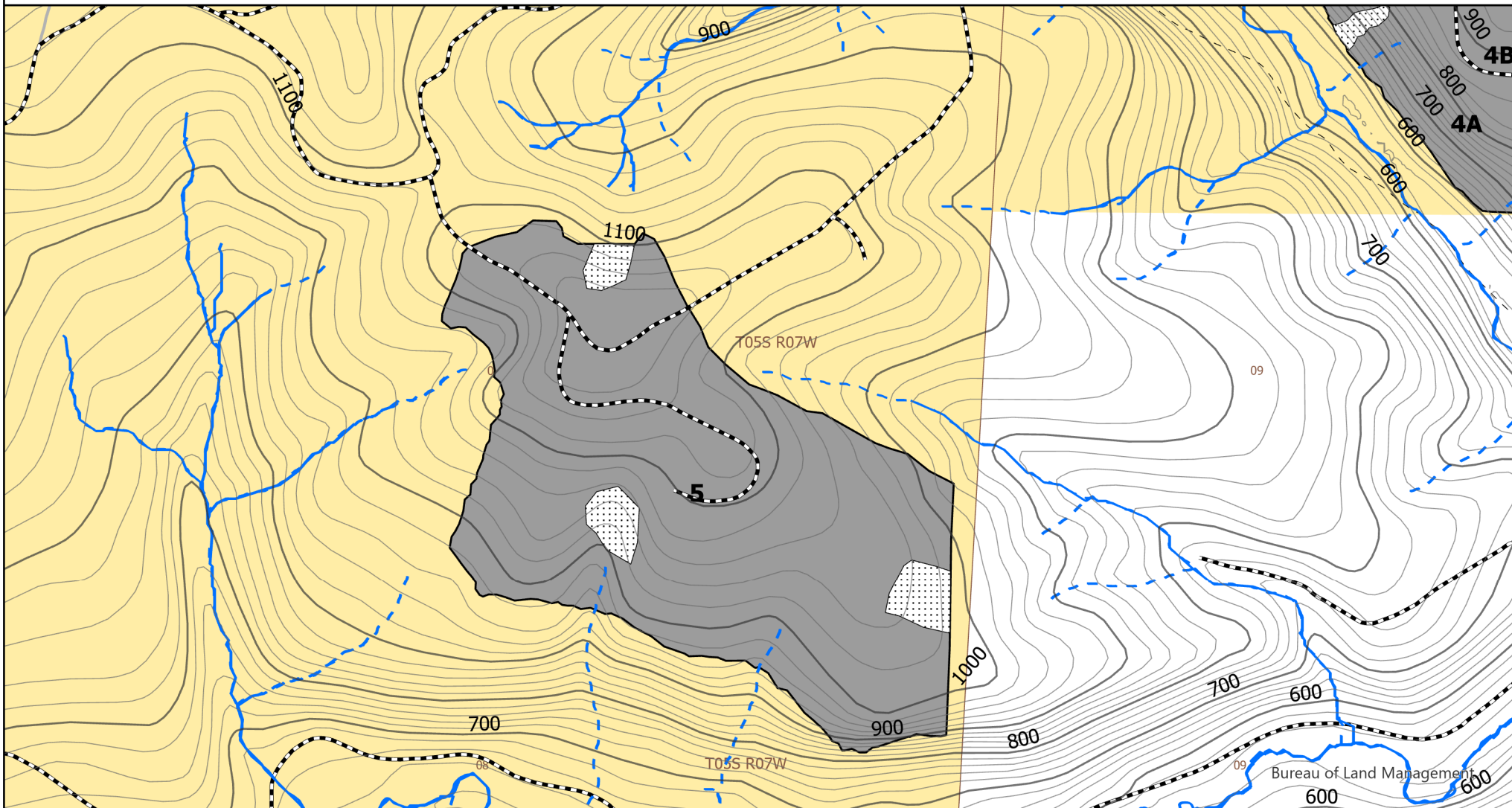

- CWD Units
- Clump
- Bureau of Land Management





CWD Unit Number	CWD Unit Acres	Total Trees	Saw-Top (ST)	High Girdle (HG)	Basal Girdle (BG)	Tree Size to be Selected (inches at DBH)	Notes
5	63	63	53	10	0	24-36	Dispersed = 53 ST. 10 HG in clump

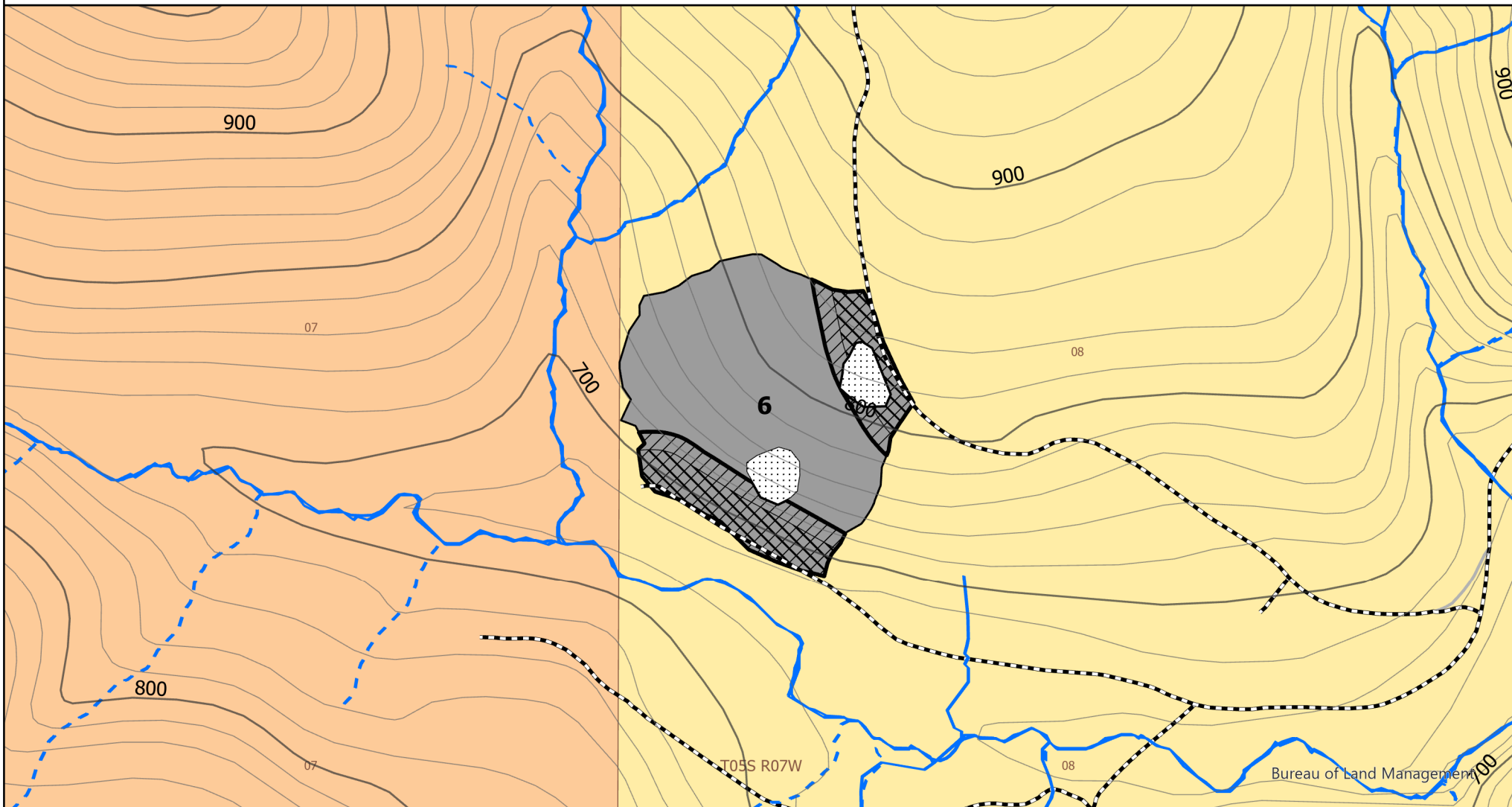

No warranty is made by the Bureau of Land Management as to the accuracy, reliability, or completeness of these data for individual or aggregate use with other data. Original data were compiled from various sources and may be updated without notification.

Big Maple Timbersale
Coarse Woody Debris Creation



-  CWD Units
-  Clump
-  No Basal Girdle
-  No Top Girdle or Saw Top
-  Bureau of Land Management

CWD Unit Number	CWD Unit Acres	Total Trees	Saw-Top (ST)	High Girdle (HG)	Basal Girdle (BG)	Tree Size to be Selected (inches at DBH)	Notes
6	11	11	8	3	0	10-15	Dispersed = 8 ST, 3 HG in clump



No warranty is made by the Bureau of Land Management as to the accuracy, reliability, or completeness of these data for individual or aggregate use with other data. Original data were compiled from various sources and may be updated without notification.

United States Department of the Interior
 BUREAU OF LAND MANAGEMENT
Big Maple Timber Sale - Vicinity Map

Northwest Oregon District - Tillamook Field Office

T. 4S. R. 7W, Section 33; T. 5S. R. 7W, Sections 3, 8 & 9 W. M. - NORTHWEST OREGON DISTRICT - OREGON

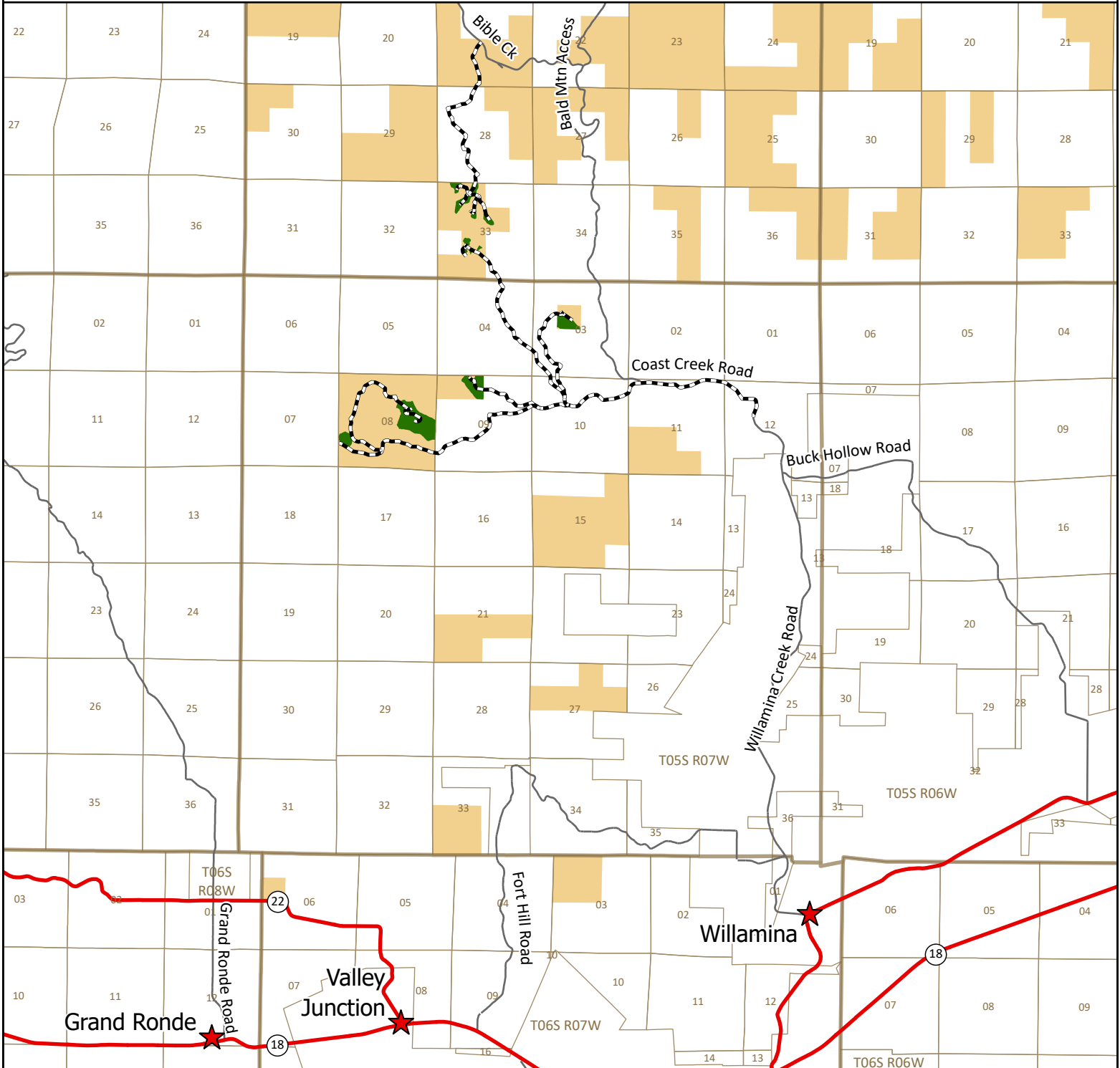

- Highways
- Big Maple Project Area
- Main Roads
- BLM Land
- - - Haul Route
- ★ Population Center

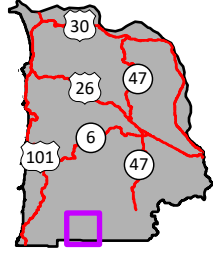
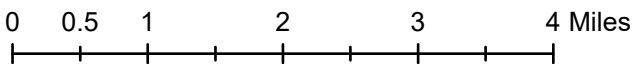

No warranty is made by the Bureau of Land Management as to the accuracy, reliability, or completeness of these data for individual or aggregate use with other data. Original data were compiled from various sources and may be updated without notification. Prepared by: dtyler 9/8/2022

Legal Description of Contract Area

Land Status	County	Township	Range	Section	Subdivision	Meridian
O&C	Yamhill	T4S	R7W	33	SW1/4NE1/4, NE1/4Sw1/4	Willamette
O&C	Yamhill	T5S	R7W	3	SE1/4NW1/4	Willamette
O&C	Yamhill	T5S	R7W	8	S1/2NE1/4, W1/2SW1/4, N1/2SE1/4	Willamette
O&C	Yamhill	T5S	R7W	9	N1/2NW1/4	Willamette

Species Totals

Species	Net	Gross Merch	Gross	# of Merch Logs	# of Cull Logs	# of Trees
Douglas Fir	6,643.0	6,931.0	6,931.0	61,587	0	14,241
Bigleaf Maple	3.0	6.0	6.0	49	87	40
Totals	6,646.0	6,937.0	6,937.0	61,636	87	14,281

Cutting Area Acres

Regeneration Harvest Acres	Partial Cut Acres	Right of Way Acres	Total Acres	Net Volume per Acre
123.0	26.0	2.0	151.0	44.0

Logging Costs

Stump to Truck	\$994,920.25
Transportation	\$343,150.00
Road Construction	\$608,115.70
Maintenance/Rockwear	\$85,269.07
Road Use	\$43,019.77
Other Allowances	\$56,419.10
Total:	\$2,130,893.89
Total Logging Cost per MBF:	\$320.63

Utilization Centers

<u>Location</u>	<u>Distance</u>	<u>% of Net Volume</u>
Williamina	15.0 miles	99 %
Garibaldi	50.0 miles	1 %

Profit & Risk

Profit	8 %
Risk	4 %
Total Profit & Risk	12 %

Tract Features

Quadratic Mean DBH	18.1 in
Average GM Log	111 bf
Average Volume per Acre	44.0 mbf
Recovery	96 %
<u>Net MBF volume:</u>	
Green	6,646.0 mbf
Salvage	0 mbf
Export	0 mbf
<u>Ground Base Logging:</u>	
Percent of Sale Volume	85 %
Average Yarding Slope	30 %
Average Yarding Distance	500 ft
<u>Cable Logging:</u>	
Percent of Sale Volume	15 %
Average Yarding Slope	48 %
Average Yarding Distance	400 ft
<u>Aerial Logging:</u>	
Percent of Sale Volume	0 %
Average Yarding Slope	0 %
Average Yarding Distance	0 ft

Cruise

Cruise Completed	December 2021
Cruised By	Mario Salmon
Cruise Method	Variable plot 20 & 40 BAF/ 100%GED

Stumpage Computation

Species	# of Trees	Net Volume	Pond Value	(-) Profit & Risk	(-) Logging Costs	(+) Marginal Log Value	Appraised Price/MBF	Appraised Value
Douglas Fir	14,241	6,643.0	\$713.76	\$85.65	\$320.63	\$0.00	\$307.50	\$2,042,722.50
Bigleaf Maple	40	3.0	\$293.32	\$35.20	\$320.63	\$0.00	\$29.40 *	\$88.20
Totals	14,281	6,646.0						\$2,042,810.70

* Minimum Stumpage values were used to compute the Appraised Price/MBF (10% of Pond Value)

Percent of Volume By Log Grade

Species	No. 1 & 2 Peeler	No. 3 Peeler	Special Mill	No. 2 Sawmill	No. 3 Sawmill	No. 4 Sawmill	Camp Run
Douglas Fir				64.0 %	33.0 %	3.0 %	

Species	No. 1 Sawmill	No. 2 Sawmill	No. 3 Sawmill	No. 4 Sawmill	No. 5 Sawmill	Camp Run
Bigleaf Maple						100.0 %

Unit: RW

Species	Net	Gross Merch	Gross	# of Trees
Douglas Fir	75.0	78.0	78.0	112
Totals:	75.0	78.0	78.0	112

Net Volume/Acre: 37.5 MBF

Regeneration Harvest	0.0
Partial Cut	0.0
Right of Way	2.0
Total Acres:	2.0

Unit: Unit 1

Species	Net	Gross Merch	Gross	# of Trees
Douglas Fir	1,469.0	1,532.0	1,532.0	2,693
Totals:	1,469.0	1,532.0	1,532.0	2,693

Net Volume/Acre: 52.5 MBF

Regeneration Harvest	28.0
Partial Cut	0.0
Right of Way	0.0
Total Acres:	28.0

Unit: Unit 2

Species	Net	Gross Merch	Gross	# of Trees
Douglas Fir	72.0	76.0	76.0	715
Bigleaf Maple	1.0	2.0	2.0	11
Totals:	73.0	78.0	78.0	726

Net Volume/Acre: 10.4 MBF

Regeneration Harvest	0.0
Partial Cut	7.0
Right of Way	0.0
Total Acres:	7.0

Unit: Unit 3

Species	Net	Gross Merch	Gross	# of Trees
Douglas Fir	816.0	851.0	851.0	1,496
Totals:	816.0	851.0	851.0	1,496

Net Volume/Acre: 51.0 MBF

Regeneration Harvest	16.0
Partial Cut	0.0
Right of Way	0.0
Total Acres:	16.0

Unit: Unit 4

Species	Net	Gross Merch	Gross	# of Trees
Douglas Fir	844.0	881.0	881.0	2,214
Bigleaf Maple	1.0	2.0	2.0	13
Totals:	845.0	883.0	883.0	2,227

Net Volume/Acre: 35.2 MBF

Regeneration Harvest	16.0
Partial Cut	8.0
Right of Way	0.0
Total Acres:	24.0

Unit: Unit 5

Species	Net	Gross Merch	Gross	# of Trees
Douglas Fir	3,264.0	3,405.0	3,405.0	5,989
Totals:	3,264.0	3,405.0	3,405.0	5,989

Net Volume/Acre: 51.8 MBF

Regeneration Harvest	63.0
Partial Cut	0.0
Right of Way	0.0
Total Acres:	63.0

Unit: Unit 6

Species	Net	Gross Merch	Gross	# of Trees
Douglas Fir	103.0	108.0	108.0	1,022
Bigleaf Maple	1.0	2.0	2.0	16
Totals:	104.0	110.0	110.0	1,038

Net Volume/Acre: 9.5 MBF

Regeneration Harvest	0.0
Partial Cut	11.0
Right of Way	0.0
Total Acres:	11.0

Comments:

Total RW: Unit 1 volume/acre(54,398) + (20, 977bf from 100% cruise strata) see. cruise report.
 Added 4 DF trees in unit 5 to total the balance total trees.

Total Stump To Truck	Net Volume	\$/MBF
\$994,920.25	6,646.0	\$149.70

Stump to Truck: Falling, Bucking, Yarding, & Loading

Yarding System	Unit of Measure	# of Units of Measure	\$/Unit of Measure	Total Cost	Remarks
Harvester/Skidder	GM MBF	276.0	\$179.16	\$49,448.16	Thinning Ground
Cable: Medium Yarder	GM MBF	1,192.0	\$176.68	\$210,602.56	Regen Cable
Harvester/Skidder	GM MBF	5,469.0	\$134.37	\$734,869.53	Regen Ground
Subtotal				\$994,920.25	

Additional Costs

Item	Unit of Measure	# of Units of Measure	\$/Unit of Measure	Total Cost	Remarks
Subtotal				\$0.00	

Additional Moves

Equipment	Unit of Measure	# of Units of Measure	\$/Unit of Measure	Total Cost	Remarks
Subtotal				\$0.00	

Comments:

Ground Base Regen: 8 loads/day @5MBF
 Ground Base Thinning: 6 loads/day @5MBF
 Cable Regen: 6 loads/day@ 5MBF

Total	Net Volume	\$/MBF
\$343,150.00	6,646.0	\$51.63

Utilization Center	One Way Mileage	Description	Unit of Measure	# of Units	\$/Unit of Measure	Total Cost	% of Sale Volume
Garibaldi	50.0	Hardwoods	GM MBF	6.0	\$75.00	\$450.00	1 %
Williamina	15.0	Conifers	GM MBF	6,854.0	\$50.00	\$342,700.00	99 %

Comments:

Conifers: Williamina \$125/hr. 5MBF per load, 2hrs. round trip.
 Hardwoods: Garibaldi \$125/hr. 5MBF per load, 3hrs. round trip.

Engineering Allowances

Total	Net Volume	\$/MBF
\$736,404.54	6,646.0	\$110.80

Cost Item	Total Cost
Road Construction:	\$608,115.70
Road Maintenance/Rockwear:	\$85,269.07
Road Use Fees:	\$43,019.77

Total	Net Volume	\$/MBF
\$56,419.10	6,646.0	\$8.49

Environmental Protection

Cost item	Total Cost
Equipment Wash	\$400.00
CWD	\$15,269.10
Subtotal	\$15,669.10

Slash Disposal & Site Prep

Cost item	Total Cost
Landing Pile Cover	\$625.00
Land Pile Burn	\$625.00
Machine Pile Burn	\$7,500.00
Lop & Scatter	\$8,000.00
Machine Pile Construction & Cover	\$24,000.00
Subtotal	\$40,750.00