

UNITED STATES
DEPARTMENT OF THE INTERIOR
BUREAU OF LAND MANAGEMENT
Northwest Oregon District Office
1717 Fabry Road, S.E.
Salem, Oregon 97306

ORN01-TS-2022.0111
Pine Crest DTR Reoffer
Date: August 15, 2022

PROSPECTUS
SEALED BID

THIS IS A PROSPECTUS ONLY. ATTACHMENTS MAY NOT INCLUDE ALL EXHIBITS REFERRED TO IN THE CONTRACT. THE COMPLETE CONTRACT, INCLUDING ALL EXHIBITS, IS AVAILABLE FOR INSPECTION AT THE NORTHWEST OREGON DISTRICT OFFICE.

NOTICE IS HEREBY GIVEN that the Bureau of Land Management will offer for sale timber as described herein for sealed bid, pursuant to Instructions to Bidders, as stated on Form No. 5440-9. **Sealed bids will be received by the District Manager, or representative, at the Northwest Oregon District Office, 1717 Fabry Road, S.E., Salem, Oregon until 4:00 p.m., Tuesday, August 30, 2022. Please call 503-375-5646 to make an appointment. Appointments are available from 8am - 4pm, M-F.** Sealed bids will be opened at 9:00 a.m. on Wednesday, August 31, 2022. All bidders will be notified via phone call after all bids have been opened and a high bidder declared.

A WRITTEN BID on Form 5440-9 at not less than the appraised price on a unit basis per species and the required minimum bid deposit shall be required to participate in sealed bidding.

TO QUALIFY FOR PARTICIPATION in a sealed bid sale, the bidder must submit a bid in a sealed envelope for each tract offered that includes:

- 1. Two copies of the bid written on Form 5440-9, Deposit and Bid For Timber/Vegetative Resources. No bid for less than the advertised appraised price on a unit basis per species and total price can be considered.**
- 2. The required minimum bid deposit specified in the timber sale notice for the tract.**
- 3. A properly executed Independent Price Determination Certificate, Form 5430-11. A certification that the bid was arrived at by the bidder or offeror independently, and was tendered without collusion with any other bidder or offeror.**
- 4. A completed Form 5450-17, Export Determination.**
- 5. The sealed envelope must be clearly marked that it is a "Bid for Timber" together with the sale name and number, the time and date of sale and a contact name and phone number of the bidder.**

THIS PROSPECTUS does not constitute the decision document for purposes of appeal of a forest management decision. Consistent with 43 CFR Subpart 5003.2(b), the date the BLM posts the forest management decision on the BLM's ePlanning website establishes the effective date of the decision for purposes of an administrative appeal. The decision was posted to the BLM's ePlanning website on 04/05/2022, referring to the Cascades Field Office Roadside Hazard Tree Project, DOI-BLM-ORWA-N010-2021-0005-EA. For the purposes of 43 CFR 5401.0-6 and 5430.0-6, this advertisement is being published on August 17, 2022, and August 24, 2022 on the BLM Timber Sale Notice Website.

AN ENVIRONMENTAL ASSESSMENT was prepared for each timber sale tract, and a Finding of No Significant Impact has been documented. These documents are available for inspection as background for each timber sale tract at the Northwest Oregon District Office.

THE VOLUMES LISTED herein are estimates only. The sale volumes listed are based on 16-foot taper breaks which must be taken into consideration if comparisons are made with volume predictions based on other standards. The volumes based on 32-foot taper breaks are shown for comparison purposes. No sale shall be made for less than the advertised appraised price. The Purchaser shall be liable for the total purchase price, without regard to the amount bid per unit, even though the quantity of timber actually cut or removed or designated for taking is more or less than the estimated volume or quantity so listed.

THIS TIMBER SALE has been cruised based upon Eastside Scribner board foot measure. The minimum bid figures shown by species are dollars per thousand board feet (MBF). The minimum bid increment will be \$0.10 per MBF.

A PERFORMANCE BOND in an amount not less than 20 percent of the total purchase price will be required for all contracts of \$2,500 or more. A minimum performance bond of not less than \$500 will be required for all installment contracts less than \$2,500.

PRE-AWARD QUALIFICATIONS. The high bidder may be required to furnish information to determine the ability to perform the obligations of the contract. If the high bidder is determined not qualified, responsible or refuses to respond within fifteen (15) days of a request for information pertaining to qualifications, the contract may be offered and awarded for the amount of the high bid to the highest of the bidders who is qualified, responsible, and willing to accept the contract.

LOG EXPORT AND SUBSTITUTION: All timber sales, including timber from Federal rights-of-ways, shall be subject to the restrictions relating to the export and substitution of unprocessed timber from the United States in accordance with P.L. 94-165 and 43 CFR 5400 and 5420, as amended.

LOG EXPORT AND SUBSTITUTION RESTRICTIONS: Excepting Port-Orford-cedar, all timber offered for sale hereunder is restricted from export from the United States in the form of unprocessed timber and is prohibited from being used as a substitute for exported private timber. The BLM has revised the log export restrictions special provision to reduce the log branding and painting requirements. The new requirements include branding of one end of all logs with a scaling diameter of over 10 inches. All loads of 11 logs or more, regardless of the diameter of the logs, will have a minimum of 10 logs branded on one end. All logs will be branded on loads of 10 logs or less. One end of all branded logs will be marked with yellow paint. At the discretion of the Contracting Officer, the Purchaser may be required to brand and paint all logs. The Purchaser shall bear any increased costs for log branding and painting.

CONTRACT TERMINATION: A revised Special Provision has been added to the contract which enables the Contracting Officer to suspend the contract to facilitate protection of certain plant or animal species, and/or to modify or terminate the contract when necessary to: (1) Comply with the Endangered Species Act or to prevent incidental take of northern spotted owls in accordance with management direction in the Record of Decision (ROD) and Resource Management Plan (RMP), or; (2) Comply with a court order, or; (3) Protect species which were identified for protection through survey and manage and/or protection buffer standards and guidelines or management direction established in the ROD and RMP.

ADDITIONAL INFORMATION concerning this timber sale tract is available at the above District Office. A copy of the timber sale contract is also available for inspection at the District Office. The prospectus for this sale is also available online at: <https://www.blm.gov/programs/natural-resources/forests-and-woodlands/timber-sales>. The prospectus includes maps and tables that cannot be made Section 508 compliant. For help with its data or information, please contact the Northwest Oregon District Office at 503-375-5646.

TIMBER SALE NOTICE
SCALE SALE

NORTHWEST OREGON DISTRICT
CASCADES FIELD OFFICE

SALE DATE: August 31, 2022

CONTRACT NO. ORN01-TS-2022.0111, **PINE CREST DTR REOFFER: SCALE SALE:**

CLACKAMAS COUNTY, OREGON: O&C: **SEALED BID: BID DEPOSIT REQUIRED: \$33,800.00.**

All timber designated for cutting on: N1/2 SE1/4, Section 30; E1/2 NE1/4, E1/2 SE1/4, SW1/4 SE1/4, Section 31; W1/2 NW1/4, Section 32; T. 6 S., R. 3 E., W.M. Lots 1-12, N1/2 NE1/4, N1/2 NW1/4 Section 5; Lot 1, SE1/4 NE1/4 Section 6; Lot 1, SE1/4 NE1/4, NE1/4 SW1/4, E1/2 SE1/4, Section 8; Lots 3-8, 10, 11, NW1/4 NW1/4, Section 9; Lots 1, 8, Section 10; T. 7 S., R. 3 E., W.M.

THIS TIMBER SALE HAS BEEN CRUISED BASED UPON EASTSIDE SCRIBNER MEASURE.

Minimum bid figures shown by species are dollars per thousand board feet (MBF). The minimum bid increment will be \$0.10 per MBF.

Approx. No. Merchantable Trees	Est. Vol. MBF 32' Log	Species	Est. Vol. MBF 16' Log	Appraised Price Per MBF	Estimated Volume Times Appraised Price
5,950	2,644	Douglas-fir	3,306	\$101.90	\$336,881.40
225	27	western hemlock	34	\$27.30	\$928.20
		biomass	1 Green Ton	\$5.00	\$5.00
6,175	2,671	TOTALS	3,340 MBF		\$337,814.60

LOG EXPORT AND SUBSTITUTION RESTRICTIONS: All timber offered for sale hereunder is restricted from export from the United States in the form of unprocessed timber and also prohibited from substitution of exported private timber.

CRUISE INFORMATION: The timber volumes were based on ocular estimation of volume combined with Variable Plot cruise used for volume determination in DTR unit, for estimated board foot volumes of trees in 16-foot logs. Approximately 100% of the total sale volume is salvage material. With respect to merchantable trees of all species; the average tree is 21.2 inches DBHOB; the average log contains 134 bd. ft.; the total gross volume is approximately 3,949 MBF; and 84% recovery is expected. This cruise information is given for informational purposes only and the contract price and volume will be determined by a scale using eastside scribner.

CUTTING AREA: Nine (9) units of Danger Tree Removal (DTR) totaling approximately 333 acres shall be cut. Unit acres shown on Exhibit A have been computed using ArcGIS to calculate area along the roads at a horizontal distance of 200 feet both sides of the road.

DURATION OF CONTRACT: Will be 12 months for cutting and removal of timber.

DIRECTIONS: The sale is located approximately 12 air miles Southeast of Molalla, Oregon. From the Oregon Highway 211 East-bound, turn right onto Mathias Rd. Drive approximately 0.2 miles and turn left onto S Feyrer Park Rd for 1.7 miles. Turn right onto S Dickey Prairie Rd and continue for 5.3 miles, then turn right over the Molalla River and continue for 0.2 miles to S Molalla Forest Rd and continue for 8.6 miles to the LOCKED GATE on the 7-3E-7.0 road on the left. See Exhibits A and E for details. Contact Northwest Oregon District Office at 503-375-5646 for a key.

ACCESS AND ROAD MAINTENANCE: Access is provided on Bureau of Land Management controlled roads. In the use of Bureau of Land Management controlled roads – Bureau of Land Management Maintenance, the Purchaser shall pay the Government a road maintenance obligation of \$5.23 per thousand board feet log scale.

In the use of Bureau of Land Management controlled roads – Purchaser Maintenance, the Purchaser will be required to perform maintenance on approximately 15.76 miles of road. The Purchaser shall pay the Government a road maintenance obligation for rockwear of \$1.52 per thousand board feet log scale for timber haul associated with the contract.

In the use of Weyerhaeuser Timber Holdings, Inc. owned roads – Purchaser Maintenance, the Purchaser will be required to perform maintenance on approximately 1.63 miles of road. The Purchaser shall enter into a license agreement with Weyerhaeuser Timber Holdings, Inc. The Purchaser shall pay Weyerhaeuser Timber Holdings, Inc. a road maintenance obligation for rockwear of \$1.19 per thousand board feet log scale for timber haul associated with the contract.

Purchaser maintenance shall include frequent blading and shaping of road surface; ditch, culvert, and catch basin cleaning; removal of minor slides and other debris. Roads shall be left in a condition to withstand adverse weather at the end of the seasonal operations.

ROAD RENOVATION: The purchaser will be required to do all work set forth below. The purchaser shall supply all materials unless otherwise indicated.

1. Estimated Quantities:

Aggregate Material:

Quantity:

690 cubic yards

400 cubic yards

Description:

3 inch-minus crushed rock Ex. C

1.5 inch-minus crushed rock Ex. C

Miscellaneous:

Brushing 20.10 acres

Blading 10.28 miles

Rock Source: Ball Road Quarry, or source that meets specs and is approved by the Authorized Officer.

Special Attention Items:

Sec. 42.l. Northern Spotted Owl – Seasonal Restriction.

Sec. 42.t. Timber Haul – Seasonal Restriction.

SEASONAL RESTRICTION MATRIX

Activity	Jan	Feb	Mar	Apr	May	June	July	Aug	Sept	Oct	Nov	Dec
Ground-based Yarding (tractor)												
Road Renovation												
Log Haul on Natural Surface Roads												
Northern Spotted Owl - Seasonal Restriction												
Haul Restriction on 6-3E-30.0 road												
Generally not allowed – or restriction applies						Generally allowed						

Sec. 41.

RESERVED

- a. All sound, green trees within the Danger Tree Removal Areas, as shown on Exhibit A.
- b. All pre-fire snags and pre-fire downed logs in Salvage Area and Danger Tree Removal Area, as shown on Exhibit A, which do not present a safety hazard as determined by the Authorized Officer. All pre-fire snags and pre-fire downed logs cut or moved for safety reasons shall be retained on site.
- c. All hardwood trees on the Danger Tree Removal Area, which do not present a safety hazard as determined by the Authorized Officer, as shown on Exhibit A.

Sec. 42.

LOGGING

- a. Before beginning the operations on the Contract Area for the first time or after a shutdown of seven (7) or more days, the Purchaser shall notify the Authorized Officer in writing of the date they plan to begin operations. The Purchaser shall also notify the Authorized Officer in writing if he intends to cease operations for any period of seven (7) or more days.
- b. Prior to the commencement of operations, the Purchaser shall obtain from the Authorized Officer written approval of a written operations and logging plan commensurate with the terms and conditions of the contract, which shall include measures needed to ensure protection of the environment and watershed. A pre-work conference between the Purchaser's authorized representative and the Authorized Officer must be held at a location designated by the Authorized Officer before the logging plan will be approved. All logging shall be done in accordance with the plan.
- c. No trees may be felled, yarded, decked, or loaded in or through the Reserve Area, as shown on Exhibit A, or adjacent private land. Trees will be directionally felled to lead for skidding to minimize ground disturbance and entry into the Reserve Area. Tops, limbs, and other logging debris entering the Reserve Area from felling operations shall be pulled back into the Danger Tree Removal Area shown on Exhibit A, unless expressly authorized by other provisions of this contract.
- d. In the Danger Tree Removal Area, all danger trees shall be felled toward the road where feasible, as directed by the Authorized Officer. Danger trees are fire-killed snags which pose a danger of striking or sliding onto existing roads within Danger Tree Removal Area, as shown on Exhibit A. All fire-killed hardwoods and non-merchantable trees within striking distance of existing roads shall be felled and retained on site. All fire-killed trees within striking distance of existing roads with a DBH of fifty (50) inches or larger shall be felled and retained on site.

e. In the Danger Tree Removal Area - Course Woody Debris Treatment Area, as shown on Exhibit A, the largest four (4) trees per acre shall be felled and left on site in a manner which do not present a safety hazard as determined by the Authorized Officer.

f. Mechanized equipment is not allowed to operate within fifty (50) feet of stream channels and wet areas when leaving existing roads. Full suspension of logs is required in order to move logs across stream channels.

g. No ground-based equipment use shall be conducted on the Salvage Area - Ground-based Yarding and Danger Tree Removal Area – Ground-based Yarding, as shown on Exhibit A, between October 15 of one calendar year and May 15 of the following calendar year, both days inclusive, or during any period of wet soil conditions as determined by the Authorized Officer.

h. In the Danger Tree Removal Area – All yarding shall be done by equipment capable of transporting the leading end of logs clear of the ground and operated entirely on designated skid roads and/or skyline corridors. Before felling and yarding any timber, the Purchaser shall locate designated skid trails and/or skyline corridors as follows:

1. Mark the location of designated skid roads and/or skyline corridors on the ground in a method approved by the Authorized Officer.
2. Space designated skid roads and/or skyline corridors at a minimum of one hundred and fifty (150) feet apart unless otherwise agreed to in writing by the Authorized Officer.
3. Limit width of skid roads and/or skyline corridors to a maximum of twelve (12) feet.
4. Obtain approval from the Authorized Officer of the location of all designated skid roads and/or skyline corridors.
5. Ground-based operations are limited to slopes of thirty-five (35) percent or less. Ground-based operations may be approved on slopes up to fifty (50) percent when using specialized equipment, operating on previously constructed skid trails, or accessing isolated areas over steep pitches. Existing skid roads should be used to the greatest extent possible and be located perpendicular to the slope to minimize road cutting.

i. All skid trails will be blocked to prevent motorized vehicle use at the end of seasonal use.

j. At all landings in the sale area, all non-merchantable logs more than eight (8) inches in diameter at the large end and exceeding eight (8) feet in length shall be decked at a location designated by the Authorized Officer. If a log or piece of log meeting or exceeding the above specifications is bucked and left in place, all portions of that log shall be yarded and decked at the designated location.

k. In the Special Yarding Area (SYA), as shown on Exhibit A. No equipment is allowed to enter the SYA, all trees will be hand felled and all trees that are yarded must be fully suspended from the ground.

l. No operations shall occur within Danger Tree Removal Areas 3, 4, and 5 from March 1st and July 15th, both days inclusive, unless waived by the Authorized Officer. The Purchaser shall notify the Authorized Officer in writing by February 1st of each calendar year in which operations are expected to take place on the Contract Area between March 1st and July 15th, both days inclusive. If notification is not received by the Authorized Officer no later than February 1st, all operations with the potential to disturb nesting northern spotted owls may not be allowed during this time period.

Upon receipt of a notice that the Purchaser expects to perform such operations during this time period, the Government will conduct surveys to determine whether owls are nesting within 0.25 miles of harvest units. If it is determined owls are not nesting or that no young have been produced, the Authorized Officer may lift the seasonal restriction on such operations. Without this approval, such operations are prohibited from March 1st through July 15th of each year, both days inclusive, unless waived by the Authorized Officer.

SAFETY

m. Purchaser's operations shall facilitate BLM's safe and practical inspection of Purchaser's operations and BLM's conduct of other official duties on Contract Area. Purchaser has all responsibility for compliance with safety requirements for Purchaser's employees, contractors, and subcontractors.

In the event that the Authorized Officer identifies a conflict between the requirements of this contract or agreed upon methods of proceeding hereunder and State or Federal safety requirements, the contract may be modified. If the cost of such contract modification is of a substantial nature (\$2,000.00 or more), the Purchaser may request, in writing, an adjustment in the total contract purchase price specified in Sec. 2 of the timber sale contract, as amended, to compensate for the changed conditions.

Unless otherwise specified in writing, when operations are in progress adjacent to or on roads and/or trails in the Salvage Area and/or Danger Tree Removal Area, Purchaser shall furnish, install, and maintain all temporary traffic controls that provide the road or trail user with adequate warning of and protection from hazardous or potentially hazardous conditions associated with its operations. Purchaser shall prepare a Traffic Control Plan, which the Purchaser has determined is compliant with state and local OSHA and Transportation standards no later than the pre-work meeting and prior to commencing operations. Traffic control devices shall be appropriate to current operating and/or weather conditions and shall be covered or removed when not needed. Flagmen and devices shall be as specified in state OSHA and Transportation standards for logging roads or the "Manual on Uniform Traffic Control Devices for Streets and Highways" (MUTCD) published by the U.S. Department of Transportation – Federal Highway Administration. Included in the Traffic Control Plan, Purchaser shall note traffic control device locations on a Purchaser produced copy of the contract Exhibit A map.

ROAD MAINTENANCE AND USE

n. The Purchaser shall renovate approximately 24.33 miles of road in strict accordance with the plans and specifications shown on Exhibit C, which is attached hereto and made a part hereof. Any required renovation, improvement, or construction of roads shall be completed and accepted, in accordance with Section 18, prior to the removal of any timber, except right-of-way timber, over that road.

o. No road renovation, improvement, or construction shall be conducted on the Contract Area shown on Exhibit A between November 1 of one calendar year and April 30 of the following calendar year, both days inclusive, or during other periods of wet soil conditions as determined by the Authorized Officer.

p. The Purchaser shall perform any required road repair and maintenance work on the roads identified as Purchaser maintenance, under the terms of Exhibit D, Road Maintenance Specifications, of this contract, which is attached hereto and made a part hereof.

q. The Purchaser is authorized to use the roads listed and shown on Exhibit E, which is attached hereto and made a part hereof, for the removal of Government timber sold under the terms of this contract, provided that the Purchaser pay the required maintenance and rockwear obligations described in Sec. 42.r. Any road listed on Exhibit D and requiring construction, improvement, or renovation in Exhibit C of this contract, shall be maintained by the Purchaser until receiving written acceptance of the construction, improvement, or renovation from the Authorized Officer. The Purchaser shall pay current Bureau of Land Management maintenance and rockwear fees for the sale of additional timber under modification to the contract.

r. The Purchaser shall pay a road maintenance fee of five and 57/100 dollars (\$5.57) per thousand board feet log scale and a rockwear fee of one and 62/100 dollars (\$1.62) per thousand board feet log scale for the use of said roads. The total fees due shall be based on volumes determined pursuant to Exhibit B of this contract, and mileage of roads used, as determined by the Authorized Officer. Prior to the use of such roads, the Purchaser shall give written notice to the Authorized Officer of the roads intended for use in the removal of timber purchased under this contract, together with an estimate of the volume to be hauled over such roads. The Authorized Officer shall establish an installment schedule of payment of the road maintenance and rockwear obligation. If it is determined by the Authorized Officer, after all merchantable timber has been cut and scaled, that the total maintenance and rockwear payments made under this contract exceed the total maintenance and rockwear payment due, such excess shall be returned to the Purchaser after such determination is made.

s. In the use of the 6-3-30.0 road, Segments A and B shown on the Exhibit E, the Purchaser shall comply with the conditions of Right-of-Way and Road Use Agreement No. S-975, between the United States of America and Weyerhaeuser Company. This document is available for inspection at the Northwest Oregon District Office.

1. Payment of a rockwear obligation for a total of three thousand seven hundred thirty-three and 91/100 dollars (\$3,733.91) to Weyerhaeuser Company, payable at the time indicated in the License Agreement.

2. Prior to the use of said roads, the Purchaser shall furnish the Authorized Officer a properly signed copy of the executed License Agreement.
 3. Default by the Purchaser of said Right-of-Way and Road Use Agreement, or any License Agreement executed pursuant thereto, for failure to pay appropriate road use fees shall be considered a violation of this contract. The amount of unpaid fees shall be considered as the amount of damage suffered by the Government as a result of the violation of this provision.
- t. No timber hauling shall be conducted on 6-3-30.0 road Segments A and B as shown on the exhibit E between October 1 of one calendar year and May 31 of the following calendar year, both days inclusive, or during other periods of wet soil conditions as determined by the Authorized Officer.

ENVIRONMENTAL PROTECTION

u. In addition to the requirements set forth in Sec. 26 of this contract, the Purchaser shall complete grass seeding, mulching or spreading of native slash on exposed soil on all skyline roads, ground-based skid roads, landings, and any other exposed soil caused by contract obligations as directed by the Authorized Officer. Grass seed and suitable equipment to apply seed shall be furnished by the Purchaser.

Seed to be supplied shall meet the following requirements:

<u>SPECIES</u>	<u>RATE</u>
Blue wild rye (<i>Elymus glaucus</i>)	100%
Oregon Certified Seed (Blue Tag)	
Purity	97% minimum
Germination	85% minimum
Noxious Weed Content	None (Tested: None Found)

The Purchaser shall apply grass seed uniformly on the designated areas at a rate equal to ten (10) pounds per acre. Evidence of seed certification shall be furnished to the Authorized Officer prior to application. Grass seed which has become wet, moldy or otherwise damaged shall not be provided.

v. In addition to the requirements set forth in Sec. 26 of this contract, in order to reduce or prevent the spread of noxious weeds to BLM lands, all road construction, piling, and ground-based logging equipment including loaders shall be cleaned of all plant parts and soil prior to entry onto BLM lands. Equipment shall be inspected by the Authorized Officer at a site approved by the Authorized Officer to verify that the equipment had been reasonably cleaned prior to entry onto BLM lands.

w. Immediately following ground-based yarding activities for any operating season, the Purchaser shall construct water bars on ground-based skid roads and block them to vehicular

traffic as directed by the Authorized Officer. The location of water bars shall be approved by the Authorized Officer prior to construction.

- x. The Purchaser shall immediately discontinue specified construction or harvesting operations upon written notice from the Authorized Officer that:
1. threatened or endangered plants or animals protected under the Endangered Species Act of 1973, as amended, may be affected by the operation, and a determination is made that consultation or reinitiation of consultation is required concerning the species prior to continuing operation, or;
 2. when, in order to comply with the Endangered Species Act or to prevent incidental take of northern spotted owls in accordance with management direction in the Record of Decision (ROD) and Resource Management Plan (RMP), or to protect occupied marbled murrelet sites in accordance with management direction of the ROD and RMP, the Contracting Officer determines it may be necessary to modify or terminate the contract, or;
 3. federal proposed, federal candidate, Bureau sensitive or State listed species protected under BLM Manual 6840 - Special Status Species Management - have been identified, and a determination is made that continued operations would affect the species or its habitat, or;
 4. when, in order to comply with a court order, which enjoins operations on the sale or otherwise requires the Bureau of Land Management to suspend operations, or;
 5. when, in order to comply with a court order, the Contracting Officer determines it may be necessary to modify or terminate the contract, or;
 6. when, in order to comply with a stay or other remedy issued by the Interior Board of Land Appeals (IBLA) the Contracting Officer determines it may be necessary to modify or terminate the contract, or;
 7. species have been discovered which were identified for protection in accordance with management direction established in the ROD and RMP, and the Contracting Officer determines that continued operations would affect the species or its habitat, or;
 8. when, in order to protect species which were identified for protection in accordance with management direction established in the ROD and RMP, the Contracting Officer determines it may be necessary to modify or terminate the contract.

Those operations necessary for a safe removal of personnel and equipment from the Contract Area and those directed by the Contracting Officer, which are required in order to leave the

contract area in an acceptable condition, will be permitted. Discontinued operations may be resumed upon receipt of written instructions and authorization by the Contracting Officer.

During any period of suspension, the Purchaser may withdraw performance and payment bond coverage aside from that deemed necessary by the Authorized Officer to secure cut and/or removed timber for which the Bureau of Land Management has not received payment, and/or unfulfilled contract requirements associated with harvest operations that have already occurred and associated post-harvest requirements.

In the event of a suspension period or a combination of suspension periods that exceed a total of thirty (30) days, the First Installment held on deposit may be temporarily reduced upon the written request of the Purchaser. For the period of suspension extending beyond thirty (30) days, the First Installment on deposit may be reduced to five (5) percent of the First Installment amount listed in Sec. 3(a) of the contract. Any First Installment amount temporarily reduced may be refunded or transferred to another BLM contract at the request of the Purchaser. However, if the Purchaser has outstanding debt owing the United States, the Contracting Officer must first apply the amount of First Installment that could be refunded to the debt owed in accordance with the Debt Collection Improvement Act, as amended (31 USC 3710, et seq.).

Upon Purchaser's receipt of a bill for collection and written notice from the Contracting Officer lifting the suspension, the Purchaser shall restore the First Installment to the full amount shown in Sec. 3(a) of the contract within fifteen (15) days after the bill for collection is issued, subject to Sec. 3(i) of the contract. The Purchaser shall not resume contract operations until the First Installment amount is fully restored.

In the event of a suspension period or a combination of suspension periods that exceed a total of thirty (30) days, the unamortized Out-of-Pocket Expenses for road or other construction required pursuant to Exhibit C of the contract shall be refunded or transferred to another BLM contract at the request of the Purchaser. Upon written notice from the Contracting Officer lifting the suspension, the Purchaser shall reimburse the Government the amounts refunded or transferred. The Purchaser may choose to pay this reimbursement at once or in installments payable at the same time as payments are due for the timber under the contract and in amounts approximately equal to the expenses associated with the timber for which payment is due.

In the event that a court-ordered injunction results in a suspension period in which the Purchaser loses operating time of thirty (30) calendar days or more of the operating season during the contract period, the Contracting Officer shall unilaterally modify the contract based on reappraisal of the remaining volume as of the date that the suspension is lifted. The thirty (30) days can be the sum of days accruing during more than one operating season. Reappraisal may result in a decrease to the unit price bid per species. Reappraisal will be based on the loss of net volume due to the deterioration of logs during the period of delay and any associated changes in the amortization of logging costs per unit of volume, as determined by the Authorized Officer. Amortization of road construction cost over a reduced net volume will be considered as well as any additional move-in or logging costs caused by the delay, as determined by the Authorized Officer. Reappraisal will adjust Exhibit B volume and values, and will not consider changes in the market price of timber. In the event that operating time is lost as a result of the incorporation of additional contract requirements, or delays due to Endangered Species Act consultation with

the U.S. Fish and Wildlife Service or U.S. National Marine Fisheries Service, or court-ordered injunctions, the Purchaser agrees that an extension of time, without reappraisal, will constitute a full and complete remedy for any claim that delays due to the suspension hindered performance of the contract or resulted in damages of any kind to the Purchaser.

In the event that operating time is lost as a result of the incorporation of additional contract requirements, or delays due to Endangered Species Act consultation with the U.S. Fish and Wildlife Service or U.S. National Marine Fisheries Service, court-ordered injunctions, or an IBLA issued stay or remedy, the Purchaser agrees that an extension of time, without reappraisal, will constitute a full and complete remedy for any claim that delays due to the suspension hindered performance of the contract or resulted in damages of any kind to the Purchaser. The Contracting Officer may determine that it is necessary to modify the contract or terminate the cutting and removal rights under the contract in order to comply with the Endangered Species Act, prevent incidental take of northern spotted owls in accordance with the ROD and RMP, protect occupied marbled murrelet sites in accordance with the ROD and RMP, protect species that have been discovered which were identified for protection in accordance with management direction established in the ROD and RMP, or comply with a court order or an IBLA issued stay or remedy. Following the issuance of a written notice that cutting and removal rights will be terminated, the Purchaser will be permitted to remove timber cut under the contract, if allowed by the Endangered Species Act, if able to proceed without causing incidental take of northern spotted owls in accordance with the ROD and RMP, consistent with marbled murrelet occupied site protection in accordance with the ROD and RMP, if consistent with species protection in accordance with management direction established in the ROD and RMP, or if consistent with a court order or IBLA issued stay or remedy.

In the event the contract is modified or cutting and removal rights are terminated under this subsection, the Purchaser agrees that the liability of the United States shall be limited to the actual costs incurred by the Purchaser which have not been amortized by timber removed from the Contract Area. This calculation of liability shall utilize actual Purchaser costs and Government estimates of timber volumes. At the Authorized Officer's request, the Purchaser agrees to provide documentation of the actual costs incurred in the performance of the contract. In addition, the Purchaser shall be released from the obligation to pay the contract price for any timber which is not authorized to be removed from the Contract Area.

The Purchaser specifically and expressly waives any right to claim damages, other than those described in the preceding paragraphs, based on an alleged breach of any duty to the Purchaser, whether express or implied, in regard to the manner in which the Government defended the litigation which resulted in the court order affecting the operation of the contract. This waiver also extends to any claims based on effects on the operation of the contract that arise from litigation against another agency. Furthermore, the Purchaser specifically acknowledges and agrees that a court ruling that the Government violated the Administrative Procedures Act cannot be interpreted, in itself, to mean that the Government had not acted reasonably in regard to its duties to the Purchaser under this contract.

FIRE PREVENTION

y. Primarily for purposes of fire prevention and control, the Purchaser shall, prior to the operation of power-driven equipment in construction or logging operations under this contract during the fire season or periods of fire danger, prepare a fire prevention and control plan to the satisfaction of the Authorized Officer. Purchaser shall take such measures for prevention and suppression of fire on the contract area and other adjacent Government lands used or traversed by Purchaser in connection with operations as are required by applicable laws and regulations. However, when in the opinion of the Authorized Officer, weather and other conditions affecting fire incidence and control make special precautions necessary to protect the contract area and said Government lands, Purchaser shall take such additional or other fire prevention and control measures as may be required by the Authorized Officer. The Purchaser shall comply with Oregon Department of Forestry Industrial Fire Precaution Level (IFPL) I Fire Season requirements. At IFPL II and III, additional fire prevention and control provisions may be added as determined by the Authorized Officer and specified in written instructions to the Purchaser to mitigate dry fuel and weather conditions.

LOGGING RESIDUE REDUCTION

z. In addition to the requirements of Sec. 15 of this contract, and notwithstanding the Purchasers satisfactory compliance with State laws and regulations regarding offsetting or abating the additional fire hazard created by this operation and the States willingness to release the Purchaser from liability for such hazard, the Purchaser shall remain responsible to the Government for performance of the following hazard reduction measure(s) required by this contract: Perform logging residue reduction and site preparation work on approximately sixty (60) acres of danger tree removal area located within harvest units. The required work shall consist of any treatment or combination of treatments, as determined by the Authorized Officer and specified in writing by the Contracting Officer. The number of acres of each treatment shall be determined by the Authorized Officer. Prior to commencement of any operation under this Section of the contract, a slash disposal and pre-work conference between the purchaser's representative and the Authorized Officer must be held at a location designated by the Authorized Officer. The number of acres of each treatment shall be determined by the Authorized Officer. All slash disposal shall be done in accordance with the plans developed at this pre-work conference. Slash, as defined for this section, shall mean all material (brush, limbs, tops, unmerchantable stems, and chunks) severed or knocked over as a result of purchasers operations under the terms of this contract.

1. Excavator pile and burn slash within 25 feet of roads in danger tree removal areas. Slash shall be piled by an excavator equipped with a hydraulic thumb. Finished piles shall be tight and free of dirt.

a. Unmerchantable logs greater than six (6) inches on the small end shall be left in place, or positioned so that they will not be burned.

b. Machine piles shall be located as far as possible from green trees, snags, or unit boundaries to minimize damage.

c. Machine piles shall be kept free of dirt and other non-wood debris and constructed as compactly as possible. There should be an adequate supply of finer fuels located within and under the covered area of the pile to ensure ignition of the larger fuels.

d. A minimum 10-foot by 10-foot cover of four (4) mil polyethylene shall cap each machine pile to maintain a dry ignition point. The cover shall be firmly fixed to each pile to hold it in place. Plastic shall be held in place with woody debris or tied with rope or twine. The plastic must be secured so that it is held in place during strong wind conditions. The Purchaser is required to furnish the covering materials. Covering shall be completed as directed by the Authorized Officer.

e. Cutting Areas shall be piled during the same season that they are logged.

f. Machine piling equipment would travel on previously used skid trails during dry soil conditions. In areas inaccessible from designated skid trails where the slope is less than 35 percent, machine piling equipment would be allowed one pass over a slash mat.

g. Slash may be left on-site or distributed along slopes, when determined by the Authorized Officer to be appropriate to minimize soil erosion.

2. Pile and burn landing slash within thirty (30) feet of the edge of each landing, all tops, broken pieces, limbs and debris more than one (1) inch in diameter at the large end and longer than three (3) feet in length shall be piled within fifteen (15) days of completion of hauling logs from that landing. Landing piles shall be kept free of dirt and located adjacent to roads at least twenty (20) feet from any Reserve Tree and/or as directed by the Authorized Officer. Upon completion of landing piling, the Purchaser shall prepare the landing piles for burning by securely covering each landing pile by securely covering each pile with four (4) mil thick polyethylene plastic film at least 20 feet wide. Landing piles shall be 75 percent covered with the covering extending three-quarters of the way down all sides. The plastic shall be oriented southwest to northeast. Pieces of burnable material shall be placed on top of the plastic to secure it from moving and to prevent it from blowing off during strong wind episodes. The Purchaser is required to furnish the covering materials. The timing of this covering work shall be in accordance with instructions from the Authorized Officer. No landing debris shall be dozed off the landing and covered with dirt. Debris which has been buried and is determined to be the source of holdover fire shall be excavated by the Purchaser, at the Purchaser's expense, with a tractor and/or hydraulic excavator as directed by the Authorized Officer. If the structure of the landing piles will not permit adequate consumption of piled debris by burning, the Purchaser shall re-pile them at the direction of the Authorized Officer.

aa. Notwithstanding the provisions of Sec. 15 of this contract, the Government shall assume all obligations for disposal or reduction of fire hazards created by Purchaser's operations

on Government lands, except for burning and mop-up assistance as required herein and measures required in Section 42.z. The Purchaser shall, under supervision of the Authorized Officer or designated representative, assist in preparing units for burning, burning, mop-up, and patrol by furnishing, at the Purchaser's own expense, the services of personnel and equipment on each unit as shown below:

1. For Igniting, Burning, Mop-up of Piles on Units:
 - a. One work leader(s) Firefighter Type 1 (FFT1) qualified according to National Wildfire Coordinating Group (NWCG) Wildland Fire Qualifications System guide, PMS 310-1 to supervise crew and equipment operations, and to serve as Purchaser's representative.
 - b. Five-person crew Firefighter Type 2 (FFT2) qualified according to National Wildfire Coordination Group (NWCG) Wildland Fire Qualifications System guide, PMS 310-1, with sufficient fuel for burning, six (6) drip torches, one (1) power saw, and one (1) backpack pump, one (1) tool for each crew member.
 - c. The crew shall arrive on the project area with radios capable of inter-crew communications and communication with a BLM representative at a ratio of one (1) radio per every five (5) crew members.
 - d. All ignition and mop-up personnel will be directly supervised by a BLM representative.

Aircraft and pilots used for Logging Residue Reduction or the suppression of escaped fires from Logging Residue Reduction operations, shall be acquired from a list of aircraft and pilots approved (i.e., carded for these specific activities) by the Office of Aircraft Services or the U.S. Forest Service. This list is available from BLM District Offices upon request.

All listed personnel shall be physically fit, experienced and fully capable of functioning as required. In addition, all listed personnel shall be qualified according to the National Wildfire Coordinating Group (NWCG) Wildland Fire Qualification System Guide, PMS-310-1 and provide documentation of these qualifications. On the day of ignition all listed personnel shall be fluent in speaking and understanding English, clothing shall consist of long pants and long sleeved shirts, and be of approved aramid fabric (Nomex™ or equivalent), as well as being free of diesel fuel oil. All personnel shall wear lug sole boots with minimum eight (8) inch tall uppers that provide ankle support, approved hardhats and leather gloves. Personnel who do not meet these requirements or do not have proper clothing and personal protective equipment (PPE) will not be allowed to participate. All listed tools and equipment shall be in good usable condition. All power-driven equipment shall be fully fueled and available for immediate use. During periods of use under this subsection, the Purchaser shall provide fuel and maintenance for all such power-driven equipment.

Except as provided hereafter for fire escapement, the Purchaser shall continue the required assistance in mop up on each cutting unit shown on Exhibit A for seventy-two (72) hours, as

directed by the Authorized Officer within a five (5) day period commencing at 8:00 a.m. the day following the completion of ignition in that unit, or until released from such service by the Government, whichever occurs first.

In event of a fire escapement, the Purchaser's personnel and equipment shall, under supervision of the Authorized Officer, take action to control and mop up the escaped fire until released from such service by the Government. If it becomes necessary to use furnished personnel and equipment for the suppression of a fire which escapes from the prescribed fire area for a period beyond the remainder of the day in which the fire escapes, then the Government shall, at its option: (1) reimburse the Purchaser for such additional use of personnel and equipment at wage rates shown in the current Administratively Determined Pay Rates for the Western Area and at equipment rates shown in the current Oregon-Washington Interagency Fire Fighting Equipment Rental Rates schedule until the Purchaser is released from such service by the Government; or (2) release the Purchaser from additional suppression work and assume responsibility for suppressing the escaped fire.

In situations where an escaped fire is controlled and contained by an adequate fire break (i.e., trail, road, stream, rock formation, etc.), the Government may permit the Purchaser to remove personnel for that day; provided that all mop up work on the escaped fire is included with mop up work on the prescribed fire area. In such an event, the Purchaser must sign a statement of agreement to complete mop up work on all escaped fire areas concurrently with mop up work on the prescribed fire area.

In case of injury to personnel or damage to equipment furnished as required by this subsection, liability shall be borne by the Purchaser, unless such injury or damage is caused by Government negligence.

Time is of the essence in complying with this provision. In the event the Purchaser fails to provide the personnel and equipment required herein, the Purchaser shall be responsible for all additional cost incurred by the Government in disposing of slash including but not limited to the wages and other costs of providing federal employees and others as substitute labor force, the cost of providing substitute equipment and appropriate additional overhead expenses. If the Purchaser's failure results in a deferral of burning and new conditions necessitate additional personnel and equipment to accomplish the planned burn, the Purchaser also shall be responsible for such additional costs.

LOG EXPORT RESTRICTION

bb. All timber sold to the Purchaser under the terms of the contract, except exempted species, is restricted from export from the United States in the form of unprocessed timber, and is prohibited from being used as a substitute for exported private timber. For the purpose of this contract, unprocessed timber is defined as: (1) any logs, except those of utility grade or below, such as sawlogs, peeler logs; and pulp logs; (2) cants or squares to be subsequently remanufactured exceeding eight and three-quarters (8-3/4) inches in thickness; (3) split or round bolts or other roundwood not processed to standards or specifications suitable for end-product uses; or (4) western red cedar lumber which does not meet lumber of American Standards

Grades of Number 3 dimension or better, or Pacific Lumber Inspection Bureau R-List Grades of Number 3 Common or better. Thus, timber manufactured into the following will be considered processed: (1) lumber and construction timbers, regardless of size, manufactured to standards and specifications suitable for end-product uses; (2) chips, pulp, and pulp products; (3) green or dry veneer and plywood; (4) poles and piling cut or treated for use as such; (5) cants, squares, and lumber cut for remanufacturing of eight and three-quarters (8-3/4) inches in thickness or less; or (6) shakes and shingles.

Substitution will be determined under the definition found in 43 CFR 5400.0-5.

The Purchaser is required to maintain and upon request to furnish the following information:

1. Date of last export sale.
2. Volume of timber contained in last export sale.
3. Volume of timber exported in the past twelve (12) months from the date of last export sale.
4. Volume of Federal timber purchased in the past twelve (12) months from the date of last export sale.
5. Volume of timber exported in succeeding twelve (12) months from date of last export sale.
6. Volume of Federal timber purchased in succeeding twelve (12) months from date of last export sale.

In the event the Purchaser elects to sell any or all of the timber sold under this contract in the form of unprocessed timber, the Purchaser shall require each party buying, exchanging, or receiving such timber to execute a Form 5460-16 (Certificate as to Non-substitution and the Domestic Processing of Timber). The original of such certification shall be filed with the Authorized Officer. Additionally, when the other party is an affiliate of the Purchaser, the Purchaser will be required to update information under item (2) of Form 5450-17 (Export Determination) and file the form with the Authorized Officer.

In the event an affiliate of the Purchaser has exported private timber within twelve (12) months prior to purchasing or otherwise acquiring Federal timber sold under this contract, the Purchaser shall, upon request, obtain from the affiliate information in the form specified by the Authorized Officer and furnish the information to the Authorized Officer. Prior to the termination of this contract, the Purchaser shall submit to the Authorized Officer Form 5460-15 (Log Scale and Disposition of Timber Removed Report), which shall be executed by the Purchaser. The purchaser shall also provide a current, interim Log Scale and Disposition of Timber Removed Report (Form 5460-15) upon request by the Authorized Officer at any time during the contract period for cutting and removal specified in Sec. 4 of this contract as amended. In addition, the Purchaser is required under the terms of this contract to retain for a three-year period from the date of termination of the contract the records of all sales or transfer of logs involving timber from the sale for inspection and use of the Bureau of Land Management.

Unless otherwise authorized in writing by the Contracting Officer, the Purchaser shall brand clearly and legibly one end of all logs with a scaling diameter (small end inside bark) of over ten (10) inches, prior to the removal of timber from the contract area. All loads of eleven (11) logs or more will have a minimum of ten (10) logs clearly and legibly branded on one end regardless

of the diameter of the logs. All logs will be branded on loads of ten (10) logs or less. One end of all branded logs to be processed domestically will be marked with a three (3) square inch spot of highway yellow paint. The Purchaser will stop trucks for accountability monitoring at mutually agreed upon locations when notified by the Authorized Officer.

If multiple trailers (mule trains) are used, each bunked load shall be considered an individual load, and these guidelines will apply to each bunked load. If a flatbed stake trailer is used, each bundle will be treated as a separate load.

At the discretion of the Contracting Officer, the Purchaser may be required to brand and paint all logs. Any increased costs for log branding and painting shall be the responsibility of the Purchaser.

In the event of the Purchaser's noncompliance with this subsection of the contract, the Authorized Officer may take appropriate action as set forth in Sec. 10 of this contract. In addition, the Purchaser may be declared ineligible to receive future awards of Government timber for a period of one year.

**UNITED STATES
 DEPARTMENT OF THE INTERIOR
 BUREAU OF LAND MANAGEMENT (BLM)
 NORTHWEST OREGON DISTRICT**

**PRESALE - EXHIBIT B - Corrected
SCALE SALE
 PURCHASE PRICE SCHEDULE AND MEASUREMENT SPECIFICATIONS**

I. **Total Actual Purchase Price** - In accordance with Section 2 and 3 of the contract, the Purchaser agrees to pay the Government for the timber sold under the contract in accordance with the following schedule and measurement requirements. Timber sold is comprised of Merchantable Timber, Merchantable Timber Remaining, and Other Timber as defined below. In the event an Extension of Time is approved, the prices per measurement unit are subject to readjustment (refer to Section 9 of the contract).

Schedule of Species/Products, Measurement Units, and Prices		
Species/Products	Measurement Unit	Price Per Measurement Unit
Douglas-fir	MBF	\$101.90
western hemlock	MBF	\$27.30
Biomass	Green Tons	\$5.00

II. **Merchantable Timber** - All timber which can be cut into logs, which equal or exceed the following specifications, shall be considered merchantable timber required to be removed from the contract area. Purchaser shall pay for same in accordance with Section 3 of the contract at the unit prices shown in Section I of this Exhibit.

Schedule of Material Specifications			
Species/Product	Length (feet)	Diameter (inches inside bark at small end)	Net Scale (% of gross volume of any log segment)
All	16 feet	10 inches	33%

If Purchaser elects to remove any logs which do not meet the above minimum material specifications and which have not been reserved to Government in Sec. 41 of the contract, such logs shall be scaled in accordance with section V of this Exhibit herein and be paid for in accordance with Section 2 and 3 of the contract and the value in Section I of this Exhibit.

III. Merchantable Timber Remaining - Measurement Requirements - The remaining volume of any merchantable sold timber on the contract area shall be determined as provided in Section 3.(g). of the contract. Purchaser shall pay for same in accordance with Section 3 of the contract at the unit prices shown in Section I of this Exhibit.

IV. Other Timber - If any timber is of a species not listed in Section I of this Exhibit the Authorized Officer shall establish volumes and values in accord with Standard BLM methods.

V. Scaling

- A. Log Rule and Measurement** - All logs shall be scaled in Eastside Scribner according to the Northwest Log Rules Eastside and Westside Log Scaling Handbook, as amended, or supplemented by BLM before the first advertisement date of the sale.
- B. Scaling Service** - A Scaling Authorization Form must be completed and approved by the Authorized Officer prior to beginning of hauling operations. All sites on the Scaling Authorization are required to have a Log Yard Agreement with the BLM. Log scaling services shall be provided and performed by BLM personnel or third-party scaling organizations under agreement with BLM.
1. All logs shall be scaled and volumes determined by BLM or a certified contract scaler.
 2. The BLM scaler or contract scaler is designated to collect Eastside MBF scale data from all loads.
 3. All logs shall be scaled using an authorized BLM scaling method approved by the Authorized Officer in accordance with BLM prescribed procedures.
- C. Defect Caused by Abnormal Delay** - Scaling deductions made for rot, check or other defect resulting from abnormal delay in scaling caused by Purchaser shall be recorded separately and charged to the Purchaser in accordance with Section 3 of the contract.
- D. Log Presentation** - Purchaser shall present logs so that they may be scaled in an economical and safe manner in accordance with the Log Yard Authorization required in Section V. B. of this Exhibit.

E. Check Scale

The BLM will conduct check scales using the following standards.

Gross Scale. A variance of one and ½ percent (1.5%) in gross scale is the standard unless otherwise justified.

Net scale. The allowable variance is as follows:

Check scaler's percent defect in logs	Scalers allowable variance
0-10 percent	2 percent
over 10 percent	0.2 * percent defect to a maximum of 5 percent

Determinations as to volume of timber made by a BLM check scaler in conformance with the standards as set forth herein shall be final. When such checks show a variance in scale in excess of acceptable standards, in two or more consecutive check scales, an adjustment to the volume reported as scaled will be made by BLM. Such adjustments will be made based on the difference between available BLM check scales and the original scale during the period covered by the unsatisfactory check scales. Unless otherwise approved in writing by the Authorized Officer, the volume to which this difference will be applied will be 50 percent of the volume scaled between the last satisfactory check and the first unsatisfactory check, 100 percent of the volume scaled during the unsatisfactory check, and 50 percent of the volume between the last unsatisfactory check scale and the next satisfactory check scale.

F. Accountability

1. Purchaser shall notify the Authorized Officer seven (7) days prior to starting or stopping of hauling operations performed under the contract.
2. All logs will be painted and branded at the landing and accounted for in accordance with Section 42 of the contract. If Sale Area is within a State that maintains a log brand register, brands shall be registered with the State. Purchaser shall use assigned brand(s) exclusively on logs from this sale until the Authorized Officer releases the brand(s).
3. Each truck driver shall obtain a load receipt and a BLM scaler receipt from the Log Truck Ticket Book issued by the Authorized Officer and comply with the instructions specified on the cover of said book. All load tickets will be marked with the cutting area number using a permanent marker or as directed by the Authorized Officer. While products are in transit, the truck driver shall display the load receipt and BLM scaler receipt on the bunk or wing log at the front of the load on the driver's side. All logs on each load shall be delivered to the destination listed on the woods receipt.

- The BLM scaler receipt shall be surrendered at the location of BLM scaling, the unloading location, or as requested by BLM. A designated area shall be identified at the yard scaling location for logs arriving during off hours. Logs arriving during off hours shall be left on the truck or may be off loaded to the designated area.
4. The Purchaser shall not haul logs from the contract area on weekends; Memorial Day, Fourth of July, Labor Day, Thanksgiving, Christmas, and New Year's holidays; or outside the hours of 4:00 a.m. to 8:00 p.m. daily, unless otherwise approved in writing by the Authorized Officer or designated in the Approved Logging Plan. (Refer to Section 42 of the contract).
 5. The Purchaser shall furnish BLM a map showing the route which shall be used to haul logs from the timber sale area to the scaling location. Such route shall be the most direct haul route between the two points, unless another route is approved by BLM. The route of haul may be changed only with advance notice to and approval by BLM. The haul route map shall be attached to the Approved Logging Plan.
 6. All loads will be scaled at locations listed on the Scaling Authorization as approved by the Authorized Officer. Purchaser shall notify the Authorized Officer seven (7) days in advance to request additional scale site locations for approval on the Scaling Authorization.
 7. Any removal of logs from loaded trucks before being accounted for and/or scaled as required by the contract shall be considered a willful trespass and render the Purchaser liable for damages under applicable law. Any payment made for purchase of such logs shall be deducted from amount due because of trespass.

G. Scaling Lost Products - The value of lost loads shall be equal to the highest value load for the month in which the lost load is hauled regardless of where the highest value load is scaled. If no loads have been scaled in that month, value will be determined from the closest month in which loads were scaled.

VI. Estimated Volumes and Values - The following volume estimates and calculations of value of timber sold are made solely as an administrative aid for determining payment amounts, when payments are due, the value of timber subject to any special bonding provisions, and other purposes specified in various portions of the contract. The cutting areas are shown on Exhibit A of the contract.

- A. Merchantable Timber Volume Removed from Contract Area** - The total volume of removed timber shall be determined using the Government's records of scaled volumes of timber skidded or yarded monthly, or a shorter period if agreed to by the Purchaser and Government, to loading points or removed from the contract area.

B. Merchantable Timber Not Yet Removed from Contract Area - The value of merchantable timber which has not been removed will be determined by multiplying the value per acre as shown below times the amount of acreage subject to the purpose of the value determination, as determined by the Authorized Officer:

Total Estimated Purchase Price And/or Schedule of Volumes and Values for Merchantable Timber Not Yet Removed from Contract Area					
Cutting Area		Total Estimated Volume (MBF)		Total Estimated PRESALE Purchase Price	
Cutting Area Number	Approximate Number of Acres	Volume per Acre	Total Volume	Value per Acre	Total Value
1	236	9.9	2339	\$1,002.66	\$236,628.30
2	14	9.5	133	\$962.72	\$13,478.10
3	43	10.1	433	\$1,019.17	\$43,824.30
4	13	10.2	133	\$1,036.78	\$13,478.10
5	10	10.0	100	\$1,011.54	\$10,115.40
6	5	13.4	67	\$1,350.54	\$6,752.70
7	6	11.2	67	\$1,125.45	\$6,752.70
8	3	11.3	34	\$1,130.00	\$3,390.00
9	3	11.3	34	\$1,130.00	\$3,390.00
Biomass	0	n/a	1 green ton	n/a	\$5.00
Sale Total	333		3340 MBF 1 green ton		\$337,814.60



SALVAGE SALE CONTRACT MAP - ORN01-TS-2022.0111

T 6S R3E sections 30, 31, 32 W.M.

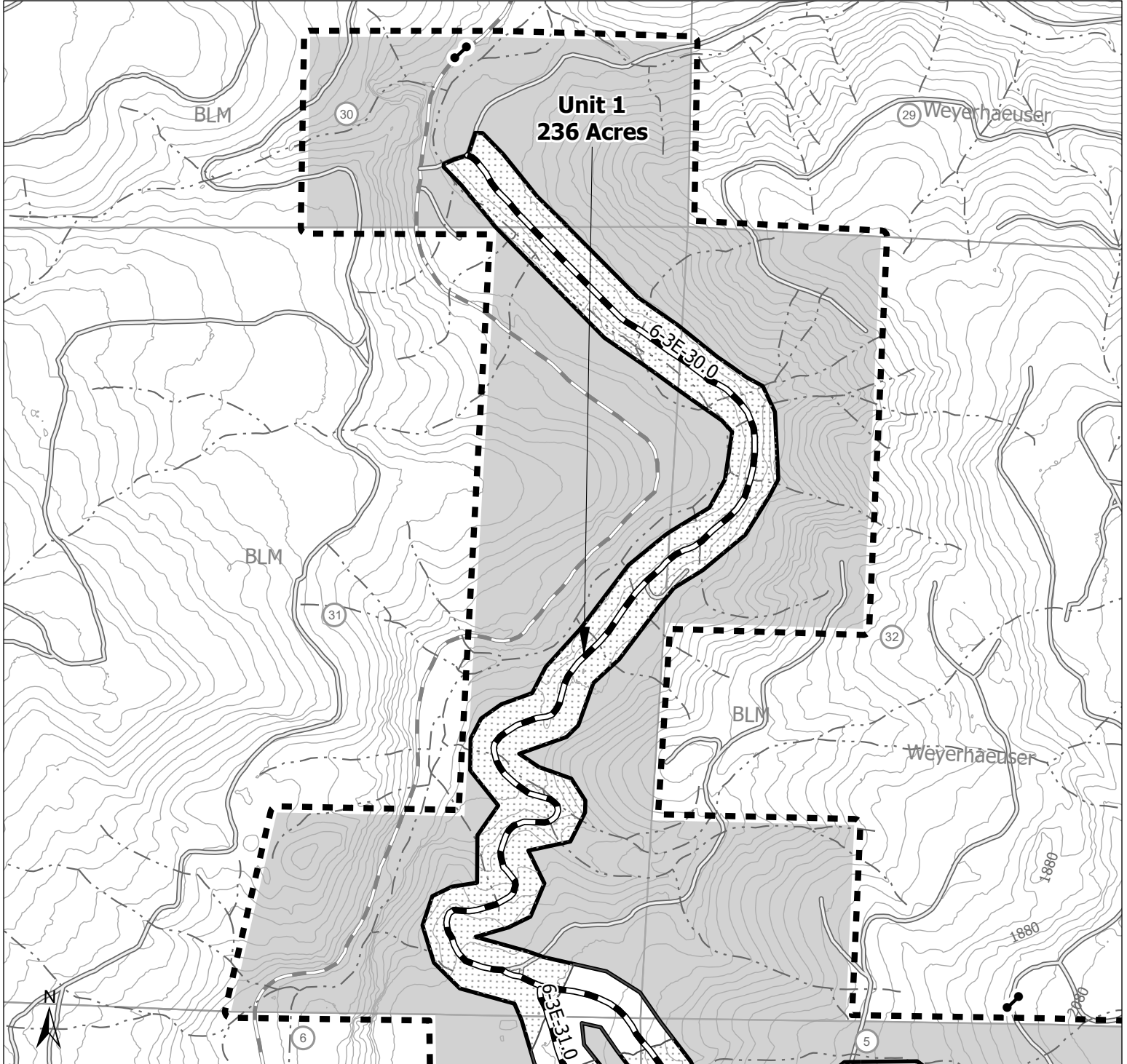

Contour Interval: 40 ft (LIDAR)

- Existing Gate
- Stream
- Existing Road
- South Molalla Road
- Road to be Renovated
- Boundary Contract Area
- Danger Tree Removal Area - Coarse Woody Debris Treatment Area
- Danger Tree Removal Area
- Reserve Area
- Boundary Cutting Area

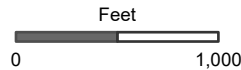

Danger Tree Removal Area	333.00 Acres
Reserve Area	1460.44 Acres
Total Contract Area	1793.44 Acres

NOTES: Unit acres do not include existing roads.



SALVAGE SALE CONTRACT MAP - ORN01-TS-2022.0111
 T 6S R3E sections 31 and 32 and T 7S R3E sections 5, 6, 8, 9 W.M.

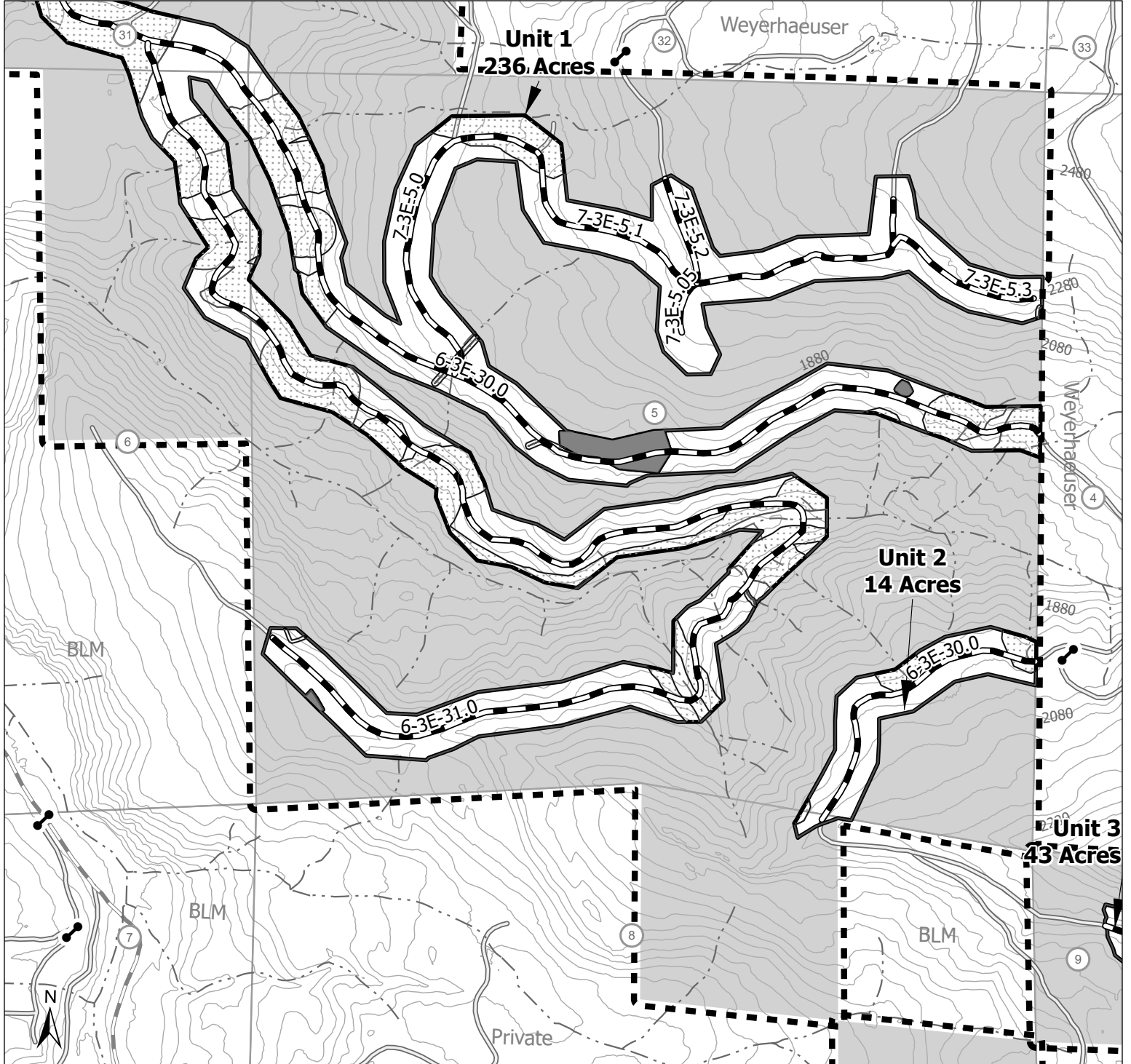

Contour Interval: 40 ft (LIDAR)

- Existing Gate
- Stream
- Existing Road
- South Molalla Road
- Road to be Renovated
- Boundary Contract Area

- Danger Tree Removal Area - Coarse Woody Debris Treatment Area
- Danger Tree Removal Area
- Special Yarding Area
- Reserve Area
- Boundary Cutting Area

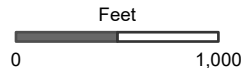

Danger Tree Removal Area	333.00 Acres
Reserve Area	1460.44 Acres
Total Contract Area	1793.44 Acres

NOTES: Unit acres do not include existing roads.



SALVAGE SALE CONTRACT MAP - ORN01-TS-2022.0111

T 7S R3E sections 5, 8, 9, 10 W.M.

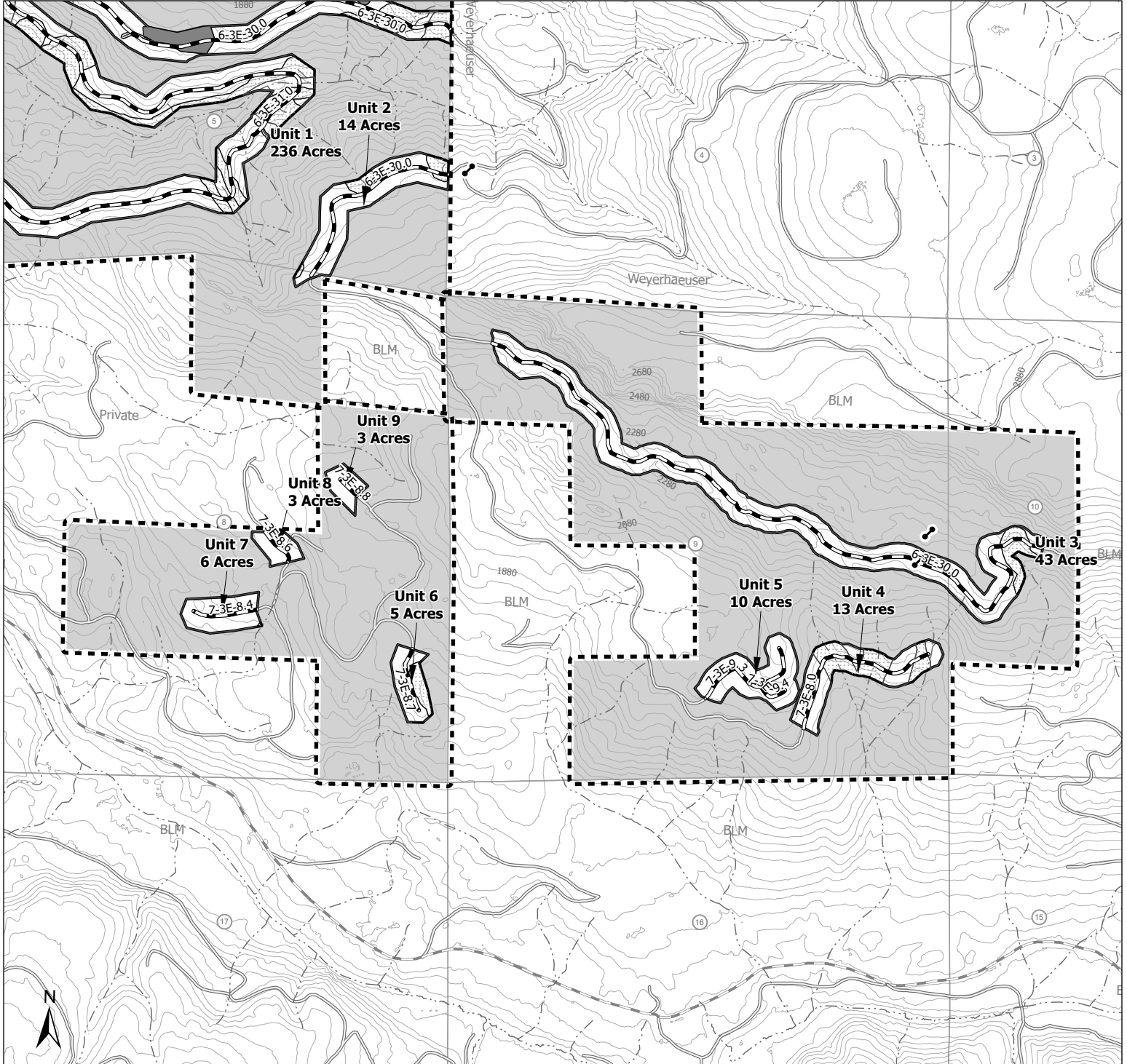

Contour Interval: 40 ft (LIDAR)

- Existing Gate
- Stream
- Existing Road
- South Molalla Road
- Road to be Renovated
- Boundary Contract Area

- Danger Tree Removal Area - Coarse Woody Debris Treatment Area
- Danger Tree Removal Area
- Special Yarding Area
- Reserve Area
- Boundary Cutting Area

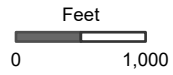

Danger Tree Removal Area	333.00 Acres
Reserve Area	1460.44 Acres
Total Contract Area	1793.44 Acres

NOTES: Unit acres do not include existing roads.

U.S. DEPT. OF THE INTERIOR
Bureau of Land Management
NORTHWEST OREGON DISTRICT - OREGON
TIMBER SALE CONTRACT

Table of Contents

Section	Sheet	Description
	1	Table of Contents
	2	Road Specifications
100	3-9	General
150	10	Road Plan and Detail Sheet
200	11-12	Clearing and Grubbing
300	12-14	Excavation and Embankment
500	15-16	Renovation and Improvement of Existing Roads
600	16-17	Watering
1000	17-20	Aggregate Base Course – Crushed Rock
1200	20-23	Aggregate Surface Course – Crushed Rock
1700	23-24	Erosion Control
1800	24-26	Soil Stabilization
2100	27-29	Roadside Brushing
	30-35	Renovation Worklist
	36	Typical Detail Sheets
	37	Road Plan Map

U.S. DEPT. OF THE INTERIOR
Bureau of Land Management
NORTHWEST OREGON DISTRICT - OREGON
TIMBER SALE CONTRACT

Road Number and Segment	Class SN-	Length (Stations and Miles)		
		New Construction	Improvement	Renovation
6-3E-6.0	20			8.57 miles
6-3E-30.0	16			6.84 miles
6-3E-31.0	16			2.50 miles
7-3E-5.05	16			0.10 miles
7-3E-5.1	16			0.56 miles
7-3E-5.2	16			0.16 miles
7-3E-5.3	16			0.20 miles
7-3E-5.0	16			0.46 miles
7-3E-7.0	16			1.72 miles
7-3E-8.0	16			1.91 miles
7-3E-8.4	16			0.15 miles
7-3E-8.5	16			0.09 miles
7-3E-8.6	16			0.06 miles
7-3E-8.7	16			0.14 miles
7-3E-8.8	16			0.38 miles
7-3E-9.3	16			0.41 miles
7-3E-9.4	16			0.08 miles

GENERAL - 100

101 - Prework Conference(s):

A prework conference will be held prior to the start of renovation, improvement, new construction, surfacing, and mulching operations. The Purchaser shall request the conference at least 7 days prior to the time it is to be held. The conference will be attended by the Purchaser and/or his representative(s), subcontractor(s) and/or his or their representative(s) and the Authorized Officer and/or his representative(s).

The purpose will be to review the required work, exhibits and specifications, and to establish a work schedule and a list of the Purchaser's representatives and subcontractor(s).

102 - Definitions:

AASHTO - American Association of State Highway and Transportation Officials. Current editions of tests and specifications.

ASTM - American Society for Testing and Materials.

Base Course - Surfacing structure consisting of crushed gravel or stone, crushed sandstone, pit run rock, bank or river-run gravels, etc., to provide support and, in the event no surface course is placed, the running surface for traffic load.

BLM - Bureau of Land Management

Borrow - Excavated material required for embankments and other portions of the work.

Culvert - A pipe, pipe-arch, arch, or box structure constructed of metal, concrete, plastic or wood which provides an opening under the roadway primarily for the conveyance of liquids, pedestrians or livestock.

Curve Widening - Widening required on inside of curves to accommodate long log and equipment hauling trucks.

Embankment - A structure of soil, aggregate, or rock material placed on a prepared ground surface and constructed to subgrade.

End Haul - Excavated material moved, other than by dozer, to an embankment or waste area to prevent sidecasting material outside of the road prism.

GENERAL – 100

Excess Excavation - Material from the roadway in excess of that needed for construction of the designed roadway (waste).

Grading - Leveling to grade, shaping and smoothing of a road subgrade; the shaping of roadside ditches as to grade and contour. In some instances includes smoothing of the cut bank.

Overhaul - Distance excavated material is transported in excess of the distance included in the cost for excavation.

Pioneer Road - Temporary construction access built along the route of the project.

Piping - The process by which soil particles are washed in or through pore spaces in drains and filters or poorly compacted fill/backfill material.

Plans - The approved drawings, or exact reproductions thereof which show the locations, character, dimensions, and details of the work to be done.

Purchaser - The individual, partnership, joint venture, or corporation contracting with the Government under the terms of a Timber Sale Contract and acting independently or through their, or its agents, employees, or contractors.

Reasonably Close Conformity - Compliance with reasonable and customary manufacturing and construction tolerances where working tolerances are not specified.

Roadbed - The graded portion of the road within top and side slopes, prepared as a foundation for the pavement structure and shoulders.

Road Centerline - Longitudinal center of roadbed.

Road Improvement - Work done to an existing road which improves it over its original design standard.

Road Renovation - Work done to an existing road which restores it to its original design.

Roadway - The portion of a road within limits of construction. Usually from the toe of the fill slope to a point where the cut slope intersects natural ground line.
Synonym - road prism.

GENERAL – 100

Scarification - The process of loosening or breaking up of the surface layer of soil or road, usually to a specified depth.

Shoulder - The portion of the roadbed contiguous with the traveled way designed for accommodation of stopped vehicles, safety, and lateral support of base and surface courses.

Slope Ratio – Slope ratio equals horizontal distance: vertical distance, HD:VD

Spalls - Flakes or chips of stone.

Specifications - A general term applied to all directions, provisions, and requirements pertaining to performance of the work.

Specific Gravity - The ratio of the density of a material to the density of water obtained by weighing known volumes of both items in air. A specific gravity less than one implies that the material will float.

Structures - Bridges, culverts, catch basins, retaining walls, underdrains, flumes, splash pads, downspouts, and other project features which may be involved in the work and not otherwise classified in these specifications.

Subbase - Reinforcement of the subgrade with large particles of pitrun or crushed stone. Usually confined to roads having wet subgrades or subgrades with weak support characteristics.

Surface Course - Top layer of a road structure consisting of finely crushed gravels or asphalt designed to provide a smooth running surface for traffic load.

Subgrade - The top surface of a roadbed upon which the traveled way and shoulders are constructed.

Timber - Standing trees, downed trees, or logs which can be measured in board feet.

Traveled Way - The portion of the roadbed used for the movement of vehicles, exclusive of shoulders.

Typical Cross Sections - Cross-sectional plane of a typical roadway; showing natural ground line and designed roadway in relation to cut and fill, through cut, and through fill.

GENERAL – 100

Turnout - Extra widening of the roadbed at appropriate intervals on single-lane roads for passing purposes.

102a - Tests Used in These Specifications:

AASHTO T 11 Quantity of rock finer than No. 200 sieve.

AASHTO T 27 Sieve analysis of fine and coarse aggregate using sieves with square openings; gradation.

AASHTO T 96 Resistance to abrasion of small size coarse aggregate by use of the Los Angeles machine.
This test required if requested by the Authorized Officer.

AASHTO T 99 Relationship between soil moisture and density of soil.
 Method A - 4" mold, soil passing a No. 4 Sieve.
 25 blows/layer & 3 layers.
 Method C - 4" mold, soil passing a 3/4 inch sieve
 25 blows/layer & 3 layers.
 Method D - 6" mold, soil passing a 3/4 inches sieve.
 56 blows/layer & 3 layers.
This test required if requested by the Authorized Officer.

AASHTO T 210 Durability of aggregate based on resistance to produce fines.
This test required if requested by the Authorized Officer.

103 - Compaction equipment shall meet the following requirements:

103a - Padded Drum (Tamping) Rollers. The unit shall consist of a drum with pads, be either self propelled or towed by a tractor, and capable of operating at a speed of 6 mph. The drum shall be no less than 48 inches in diameter over the pads and not less than 60 inches in width. The pads shall have a minimum height of 3 inches, and a face area of not less than 14 square inches. The weight at drum shall be no less than 8000 lb.

GENERAL – 100

- 103b - (Sheepfoot) (Tamping) rollers. A tamping roller unit shall consist of two watertight metal drums mounted in frames in such manner as to be fully oscillating, together with a tractor having sufficient weight and power under actual working conditions to pull the roller drums at a minimum speed of 2.5 miles per hour. The drums shall be no less than 60 inches in diameter and no less than 54 inches in length, measured at the drum's surface, and shall be studded with tamping feet projecting not less than 7 inches from the face of the drums.

The distance between circumferential rows of tamper feet shall be such that the diagonal distance from any foot to the nearest foot in each adjacent row shall be not more than 12 inches. The cross-sectional area of the face of each tamper foot, measured perpendicular to the axis of the stud, shall be not less than 5-1/2 square inches nor more than 8 square inches.

The weight of the tamping-roller unit shall be such as to exert a minimum pressure of 250 pounds per square inch on the ground area in contact with the tamping feet, and the roller shall be so designed that the weight may be increased to exert a pressure up to 500 pounds per square inch on the ground area in contact with the tamping feet. The ground pressure shall be determined by dividing the total weight of the roller unit, not including the weight of the tractor, by the total cross-sectional area of the tamping feet in one row of tamping feet parallel to the axis of the roller.

- 103c - Smooth-wheel power rollers. Smooth-wheel power rollers shall either be of the 3-wheel type, weighing not less than 10 tons, or of the tandem type, 2-wheel or 3-wheel, weighing not less than 8 tons. Smooth-wheel roller shall provide compression of 325 pounds per linear inch of width of rear wheels or drum.

GENERAL – 100

- 103e - Grid roller. A grid roller shall consist of two or more cylindrical drums independently mounted on a common shaft in a rigid frame. Each drum shall have a minimum outside diameter of 5 feet and a minimum width of 2 feet 6 inches. The overall width of the roller exclusive of frame shall be not less than 5 feet 6 inches of which not more than 6 inches shall be used for center spacing between two roller drums. The face of the drums shall have the appearance of woven open-mesh made by interlacing bars of not less than 1-1/4 inches nor more than 1-3/4 inches diameter space spaced on 4-1/2 inches to 5-1/2 inches center. Net opening between the bars shall be not less than 3 inches nor more than 4 inches. The roller shall be so constructed that counterweights can be used to adjust the gross weight of the roller to not less than 27,000 pounds. The grid roller shall be drawn by a power unit capable of propelling the fully loaded roller through 6 inches of loose embankment material at a speed of at least 4 miles per hour.
- 103f - Vibratory roller. The drum diameter shall be not less than 48 inches, the drum width not less than 58 inches, and have a turning radius of 15 feet or less. Vibration frequency shall be regulated in steps to 1400, 1500, and 1600 vibrations per minute (VPM), corresponding to engine speeds of 1575, 1690, and 1800 RPM. The centrifugal force developed shall be 7 tons at 1600 RPM. It shall be activated by a power unit of not less than 25 horsepower. The vibratory roller shall be self-propelled or drawn by a vehicle of sufficient horsepower to enable the unit to travel through a loose layer of material at a speed ranging from 0.9 mile to 1.8 miles per hour, as directed by the Authorized Officer.
- The towing vehicle and roller or self-propelled unit meeting the above requirements shall be considered a vibratory roller unit.
- 103g - Vibratory compactor. Vibratory compactors shall consist of multiple or gang-type compacting units or pads with a minimum variable width of 2 feet. It shall be self-contained and capable of compacting material as required.
- 103h - Drum drive self-propelled vibratory grid roller. The unit shall consist of one cylindrical drum with a drum diameter of not less than 56 inches, nor more than 66 inches and the drum width shall be 84 inches. Vibratory frequency shall be regulated in seeps from 1200 to 1800 vibrations per minute (VPM), and the centrifugal force developed shall be at least 40,000 pounds at 1800 RPM. The vibratory grid roller shall be self-propelled and have a power unit of not less than 112 horsepower. The "grid" design shall be a herringbone or z-bar pattern around the circumference of the drum. The grid bars shall be 1 inch in height and spaced not more than 8-1/2 inches apart.

GENERAL – 100

- 103i - Other. Compaction equipment approved by the Authorized Officer.
- 105 - All project activities shall meet the following BMP requirements:
 - 105a - All heavy equipment shall be cleaned prior to initially entering or operating on BLM lands. The equipment shall be free of noxious weed seed, external petroleum residue, caked on dirt or grime, and other contaminants. Any leakage or contamination risk shall be corrected prior to continuing operation. An inspection by the Authorized Officer is required prior to beginning work.
 - 105b - No refueling of any heavy equipment shall be done within 100 feet of standing or running water.
 - 105c - The Purchaser and/or his representative(s), subcontractor(s) and/or his or their representative(s) shall comply with the following Sections of this contract in connection with any operations under this contract:

Section 26 - Watershed Protection

Section 27 - Refuse Control and Disposal of Waste Materials

Section 28 - Storage and Handling of Hazardous Materials

U.S. DEPT. OF THE INTERIOR
Bureau of Land Management
NORTHWEST OREGON DISTRICT OFFICE - OREGON
150: ROAD PLAN AND DETAIL SHEET

Sale Name Pine Crest DTR Reoffer

EXHIBIT C

Contract No. ORNO1-TS-2022.0111

Sheet 10 of 38

Road Number	From: Mile Post	To: Mile Post	Length	Typical Section Type	Min Curve Radius	Road Width		Gradient		Clearing Width(*7)				Surfacing										REMARKS		
						Subgrade Width	Ditch Depth	Fav	Adv	Beyond		Existing Roads (*6)		Base Course					Surface Course							
										Top Cut	Toe Fill	L	R	Minimum Width	Compact Depth	Surface Type	Grading Size	Number of Lifts	Minimum Width	Compact Depth	Surface Type	Grading Size	Number of Lifts			
6-3E-30.0	0.00	6.84	6.84	6	-	16'	2'	-	-	-	-	-	-	-	-	-	-	-	-	-	-	-	-	-	-	100 cu yd 3" spot rock , 100 cu yd 1.5" spot rock
6-3E-31.0	0.00	2.5	2.5	6	-	16'	2'	-	-	-	-	-	-	-	-	-	-	-	-	-	-	-	-	-	-	150 cu yd 3" spot rock
7-3E-5.05	0.00	0.1	0.1	6	-	16'	2'	-	-	-	-	-	-	-	-	-	-	-	-	-	-	-	-	-	-	
7-3E-5.1	0.00	0.56	0.56	6	-	16'	2'	-	-	-	-	-	-	-	-	-	-	-	-	-	-	-	-	-	-	
7-3E-5.2	0.00	0.16	0.16	6	-	16'	2'	-	-	-	-	-	-	-	-	-	-	-	-	-	-	-	-	-	-	
7-3E-5.3	0.00	0.2	0.2	6	-	16'	2'	-	-	-	-	-	-	-	-	-	-	-	-	-	-	-	-	-	-	
7-3E-5.0	0.00	0.46	0.46	6	-	16'	2'	-	-	-	-	-	-	-	-	-	-	-	-	-	-	-	-	-	-	100 cu yd 3" spot rock and 300 cu yd 1.5" to cover all spurs in system
7-3E-7.0	0.00	1.72	1.72	6	-	16'	2'	-	-	-	-	-	-	-	-	-	-	-	-	-	-	-	-	-	-	100 cu yd 3" spot rock
7-3E-8.0	0.00	1.91	1.91	6	-	16'	2'	-	-	-	-	-	-	-	-	-	-	-	-	-	-	-	-	-	-	100 cu yd 3" spot rock
7-3E-8.4	0.00	0.15	0.15	6	-	16'	2'	-	-	-	-	-	-	-	-	-	-	-	-	-	-	-	-	-	-	20 cu yd 3" spot rock
7-3E-8.5	0.00	0.09	0.09	6	-	16'	2'	-	-	-	-	-	-	-	-	-	-	-	-	-	-	-	-	-	-	20 cu yd 3" spot rock
7-3E-8.6	0.00	0.06	0.06	6	-	16'	2'	-	-	-	-	-	-	-	-	-	-	-	-	-	-	-	-	-	-	
7-3E-8.7	0.00	0.14	0.14	6	-	16'	2'	-	-	-	-	-	-	-	-	-	-	-	-	-	-	-	-	-	-	20 cu yd 3" spot rock
7-3E-8.8	0.00	0.38	0.38	6	-	16'	2'	-	-	-	-	-	-	-	-	-	-	-	-	-	-	-	-	-	-	20 cu yd 3" spot rock
7-3E-9.3	0.00	0.41	0.41	6	-	16'	2'	-	-	-	-	-	-	-	-	-	-	-	-	-	-	-	-	-	-	50 cu yd 3" spot rock
7-3E-9.4	0.00	0.08	0.08	6	-	16'	2'	-	-	-	-	-	-	-	-	-	-	-	-	-	-	-	-	-	-	10 cu yd 3" spot rock

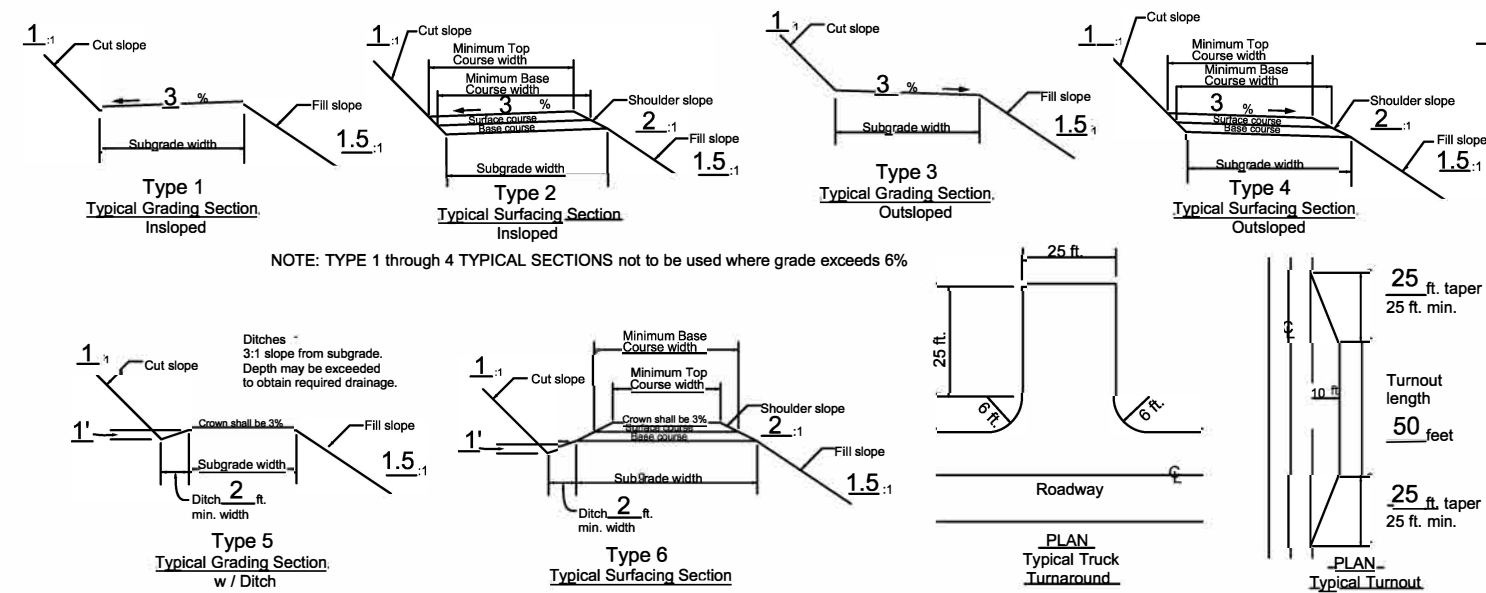

***NOTES**

- Extra subgrade widths**
Add to each shoulder: 1 foot for fills of 1 to 6 feet. Widen inside or outside shoulder of tight curves as needed for log trucks to maneuver, with tires remaining on roadbed.
- Backslopes.**
Materials:

	Cut slopes	Fill slopes
Solid rock	1/2:1	Angle of repose
Soft rock and shale	3/4:1	1:1
Common		
Slopes under 55%	1:1	1-1/2:1
Slopes over 55%	1-1/2:1	1-1/2:1

Note: Full bench construction is required on side slopes exceeding 60%.
Slope Ratio = Horizontal Distance:Vertical Distance (HD:VD)
- Surface type.**
PRR - Pit run rock
GRR - Grid rolled rock
SRN - Screened rock
JRR - Jaw run rock
ABC - Aggr. base course
ASC - Aggr. surface course
WC - Wood chips
- Grading.**

C	- 1 1/2" minus
D	- 1" minus (surface course)
E	- 3/4" minus (base course)
A	- 3" minus
B	- 2" minus (base course)
C	- 3"
- Turnouts.**
Width shall be 10 feet in addition to the subgrade width, with lengths as shown on this plan, or as directed by the Authorized Officer.
- Surfacing.**
Turnouts, curve widening, and the first 50 feet of all road aprons shall be surfaced, for all road stations requiring surfacing, as listed above, and as directed by the Authorized Officer.
- Clearing width.** 200
See Section
- As posted and painted for Right-of-Way, and as required in Section 2100 of this contract.**
- Grading (Renovation).** 500
See Section
- Drainage.** 400
See Section
Culvert site aggregate, as designated in Section 400 of this contract, does not fulfill any requirements as listed above for full lifts of surface or base applications.
- Compaction.** 300 and 500
See Sections

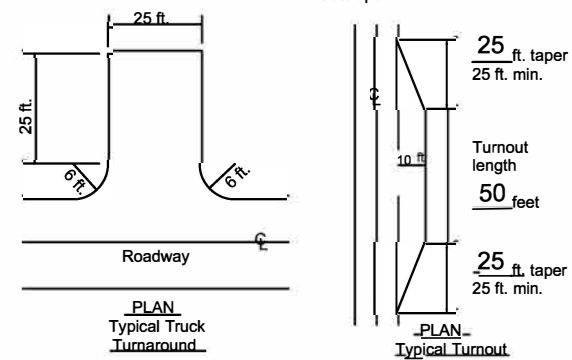

CLEARING AND GRUBBING - 200

- 201 - This work shall consist of clearing, grubbing, removing and disposing of vegetation, debris, surface objects, and protruding obstructions within the clearing limits in accordance with these specifications and conforming to the lines, grades, dimensions and typical cross sections shown on the plans and as staked on the ground.
- 202 - Where clearing limits have not been staked, established by these specifications or shown on the plans, the limits shall extend 4 feet back of the top of the cut slope and 4 feet out from the toe of the fill slope.
- 202a - Where clearing limits for structures have not been staked or shown on the plans, the limits shall extend 10 feet out from the outside edge of the structure.
- 203 - Clearing shall consist of the removal and disposal of trees, logs, rotten material, brush, and other vegetative materials and surface objects in accordance with these specifications and within the limits established for clearing as specified under Subsections 202, and 202a, as shown on the plans, and as staked on the ground and/or as posted.
- 203b - Standing trees and snags to be cleared shall be felled within the limits established for clearing unless otherwise authorized.
- 204 - Grubbing shall consist of the removal and disposal of stumps, roots, and other wood material embedded in the ground and protruding obstacles remaining as a result of the clearing operation and in accordance with Subsections 204a, and 204c between the top of the cut slope and the toe of the fill slope.
- 204a - Stumps, including those overhanging cut banks, shall be removed within the required excavation limits.
- 204c - On excavated areas, roots and embedded wood shall be removed to a depth not less than 6 inches below the subgrade.
- 205 - Clearing and grubbing debris shall not be placed or permitted to remain in or under road embankment sections. Such debris will, however, be permitted to remain under waste material from full-bench construction on steep side slopes.
- 210 - Disposal of clearing and grubbing debris shall be by scattering over government owned lands outside of established clearing limits in a manner acceptable to the Authorized Officer. The areas for such scattering shall have the prior approval of the Authorized Officer.

CLEARING AND GRUBBING - 200

- 210a - Disposal of clearing and grubbing debris shall be by piling on government lands outside of established clearing limits in an area and in a manner acceptable to the Authorized Officer, when accumulations are too great to scatter.
- 210b - Disposal of clearing and grubbing debris, stumps and cull logs on non-government property by scattering this material outside of clearing limits will not be permitted unless the Purchaser obtains a written permit, or other approved documentation, from the property owner on whose property the disposal is to be made. The Purchaser shall furnish the Authorized Officer a certified copy of the permit and a written release from the property owner absolving the Government from responsibilities in connection with the disposal of debris on said property.
- 212 - No grading will be permitted prior to completion and approval by the Authorized Officer of the required clearing and grubbing work, except that stump grubbing may proceed with the excavation of the road prism.
- 213 - No clearing or grubbing debris shall be left lodged against standing trees or otherwise impede tree felling on any trees within the existing stands adjacent to the road construction.

EXCAVATION AND EMBANKMENT - 300

- 301 - This work shall consist of excavating, overhaul, placement of embankments, backfilling, borrowing, leveling, ditching, grading, insloping, outsloping, crowning and scarification of the subgrade, compaction, disposal of excess and unsuitable materials, and other earth-moving work in accordance with these specifications and conforming to the lines, grades, dimensions, and typical cross sections shown on the plans.
- 302 - Excavation shall also consist of the excavation of road and landing cut sections, borrow sites, backfilling, leveling, ditching, grading, compaction, and other earth moving work necessary for the construction of the roadway in accordance with these specifications and conforming to the lines, grades, dimensions, and typical cross sections shown on the plans.
- 303 - Suitable material removed from the excavation shall be used in the formation of embankment subgrade, shoulders, slopes, bedding, backfill for structures, and for other purposes as shown on the plans.

EXCAVATION AND EMBANKMENT - 300

- 304 - Borrow shall consist of suitable material required for the construction of embankments or for other portions of the work; such material shall be obtained from sources selected by the Purchaser at his option and approved by the Authorized Officer.
- 305 - Embankment construction shall consist of the placement of excavated and borrowed materials, backfilling, leveling, grading, compaction, and other earth-moving work necessary for the construction of the roadway and landings in accordance with these specifications and conforming to the lines, grades, dimensions, and typical cross sections shown on the plans.
- 305a - Material used in the construction of embankment sections shall be free of stumps, cull logs, brush, muck, sod, roots, frozen material and other deleterious materials and shall be placed and compacted as specified.
- 305b - Embankment materials shall be placed in successive parallel layers on areas cleared of stumps, cull logs, brush, sod, and other vegetative and deleterious materials, except as provided under Subsection 204. Roadway embankments of earth material shall be placed in horizontal layers not exceeding 12 inches in depth.
- 306 - Layers of embankment, selected borrow, final subgrade, and selected roadway excavation material as specified under Subsections 305a, and 305b shall be moistened or dried to uniform optimum moisture content suitable for maximum density and compacted to full width with compacting equipment conforming to requirements of Subsections 103f, 103g and 103i.
- 306e - The final subgrade, including landings, shall be compacted to full width with compacting equipment conforming to the requirements of Subsections 103f, 103g, and 103i until visible displacement ceases.
- 308 - In the case of rock fills, placement of material in layers is not required and such material may be placed by end-dumping or other methods approved by the Authorized Officer provided that the rock shall be reasonably prevented from escaping beyond the embankment toe.
- 313 - In cut areas where solid rock is encountered at, or near subgrade, the rock shall be excavated to a minimum depth of 6 inches below subgrade elevation and the excavated area backfilled with suitable material. The backfill material shall be processed to the optimum moisture content suitable for maximum density and compacted to full width in accordance with the requirements of Subsection 306e.

EXCAVATION AND EMBANKMENT - 300

314 - When heavy clays, muck, clay shale, or other deleterious material for forming the roadbed is encountered in cuts at subgrade, it shall be excavated to a minimum depth of 2 feet below the subgrade elevation and the excavated area backfilled with a selected borrow material approved by the Authorized Officer. The backfill material shall be uniformly moistened or dried to the optimum moisture content suitable for maximum density in accordance with the requirements of subsection 306. Unsuitable material shall be disposed of as directed by the Authorized Officer.

316 - Borrow material from sources selected at the Purchaser's option shall be inspected and approved in writing by the Authorized Officer prior to placement.

318 - Selected borrow or selected roadway excavation material shall be uniformly spread on the roadbed in lifts not to exceed 8 inches in depth until the required thickness shown on the plans is attained.

Each layer shall be uniformly moistened or dried to the optimum moisture content suitable for maximum density and compacted to full width in accordance with the requirements of Subsection 306.

320 - Ditches shall conform to the slope, grade, dimensions, and shape of the required cross section shown on the Section 150 sheet. Roots, stumps, rocks, and other projections shall be removed to form smooth, even slopes.

321 - Excess excavated, unsuitable, or slide materials shall not be disposed of on areas where the material will encroach on a stream course or other body of water. Such materials shall be disposed of in accordance with Subsection 321c.

321c - End-dumping will be permitted for the placement of excess materials under Subsection 321 in designated disposal areas or within areas approved by the Authorized Officer. Watering, rolling, and placement in layers is (not) required. Materials placed shall be sloped, shaped, and otherwise brought to a neat and sightly condition acceptable to the Authorized Officer. Exposed soils must be seeded and mulched in accordance with Section 1800 of this Contract.

324 - Excavated material shall not be allowed to cover boles of standing trees to a depth in excess of 2 feet on the uphill side.

327 - The finished grading shall be approved by the Authorized Officer in segments or for the total project. The Purchaser shall give the Authorized Officer 3 days notice prior to final inspection of the grading operations.

RENOVATION OF EXISTING ROADS - 500

- 501 - This work shall consist of reconditioning and preparing the roadbed and shoulders, minor excavation and/or embankment, cleaning and shaping drainage ditches, trimming vegetation from cut and embankment slopes, and cleaning and repairing drainage structures of existing roads in accordance with these specifications and as shown on the plans.

- 501a - This work shall include the removal and disposal of slides in accordance with these specifications.

- 502 - The existing road surface shall be bladed and shaped to the lines, grades, dimensions, and typical cross sections shown on the plans at the following locations:

Road No.	From Sta./M.P.	To Sta./M.P.
6-3E-30.0	0.00 mile	3.00 mile
6-3E-31.0	0.00 mile	2.50 mile
7-3E-5.3	0.00 mile	0.10 mile
7-3E-5.05	0.00 mile	0.10 mile
7-3E-5.0	0.00 mile	0.46 mile
7-3E-7.0	0.00 mile	1.72 mile
7-3E-8.0	0.00 mile	1.52 mile
7-3E-8.8	0.00 mile	0.38 mile
7-3E-9.3	0.00 mile	0.41 mile
7-3E-9.4	0.00 mile	0.08 mile

RENOVATION OF EXISTING ROADS - 500

- 502a - Rocks larger than 6 inches in maximum dimension shall be removed from the scarified layers of the roadbed. Material so removed will not be permitted to remain on road shoulders or in ditches.
- 504 - Existing road surfaces shall be uniformly moistened or dried to the optimum moisture content suitable for maximum density and compacted to full width with equipment conforming to requirements of Subsections 103f, and 103i, until visible displacement ceases, generally 4 stations per hour.
- 506 - The inlet end of existing drainage structures shall be cleared of vegetative debris and boulders that are of sufficient size to obstruct normal stream flow. Pipe inverts shall be cleared of sediment and other debris lodged in the barrel of the pipe. The outflow area of pipe structures shall be cleared of rock and vegetative obstructions which will impede the structure's designed outflow configuration. Catch basins shall conform to the lines, grade, dimensions, and typical diagram shown on the plans.
- 508 - Vegetation encroaching on the roadbed and the drainage ditches of existing roads shall be removed by cutting and disposed of in accordance with Subsection 2100 of these specifications.
- 509 - The finished grading shall be approved by the Authorized Officer. The Purchaser shall give the Authorized Officer 3 days notice prior to final inspection of the grading operations.

WATERING - 600

- 601 - This work shall consist of furnishing and applying water required for the compaction of embankments, roadbeds, backfills, base courses, surface courses, finishing and reconditioning of existing roadbeds, or for other uses in accordance with these specifications.
- 602 - Water, when needed for compaction shall be applied at the locations, in the amounts, and during the hours as directed by the Authorized Officer. Amounts of water to be provided will be the minimum needed to properly execute the compaction requirements in conformance with these specifications.
- 603 - Water trucks used in this work shall be equipped with a distributing device of ample capacity and of such design as to ensure uniform application of water on the roadbed.

WATERING - 600

- 604 - Water required under these specifications is subject to applicable State water regulations.
- 605 - The Purchaser shall secure the necessary water permits for use of water source(s) selected by the Purchaser and approved by the Authorized Officer.

AGGREGATE BASE COURSE - 1000
CRUSHED ROCK MATERIAL

- 1001 - This work shall consist of furnishing, hauling, and placing one or more lifts of crushed rock material on roadbeds, turnouts and landings approved for placing crushed rock material, in accordance with these specifications and conforming to the dimensions and typical cross sections shown on the Section 150 plans. Material not conforming to these specifications will be rejected, and shall be removed from the road.
- 1002a - Crushed rock materials may be obtained from commercial sources selected by the Purchaser at his option and expense providing that the rock materials selected comply with the specifications in this section.
- 1003 - Crushed rock material produced from gravel shall have 2 manufactured fractured faces on 65 percent, by weight, of the material retained on the No. 4 sieve.
- 1004 - Crushed rock materials shall consist of hard durable rock fragments conforming to the following gradation requirements:

TABLE 1004
AGGREGATE BASE COURSE
CRUSHED ROCK MATERIAL

Percentage by Weight Passing Square Mesh Sieves
(AASHTO T 11 & T 27)

GRADATION

Sieve Designation	A	B	C	D	F	G	H	JRR
(6) -inch	-	-	-	-	-	-	-	100
3-inch	100	-	100	-	100	-	-	-
2-inch	90-95	100	-	100	65-95	100	100	-
1½-inch	-	90-95	-	-	-	-	-	-
1-inch	45-75	50-90	-	-	-	50-85	60-90	-
¾-inch	-	-	-	-	28-70	-	-	-
½-inch	-	-	-	-	-	27-60	44-70	-
⅜-inch	-	-	-	-	-	-	-	-
No. 4	15-45	15-50	-	-	10-35	15-40	28-50	-
No. 8	-	-	-	-	-	-	20-41	-
No. 10	-	-	-	-	-	-	-	-
No. 30	-	-	-	-	5-22	8-26	9-26	-
No. 40	5-25	5-25	-	-	-	-	-	-
No. 200	2-15	2-15	-	-	3-10	3-12	3-12	-

AGGREGATE BASE COURSE - 1000
CRUSHED ROCK MATERIAL

- 1004a - The Purchaser shall be required to take 1 sample of each 2,000 cubic yards of crushed rock material produced, using approved AASHTO sampling procedures. The Purchaser shall submit samples to a certified lab or shall perform testing for gradation requirements using ASHTO T 11 and AASHTO T 27 testing procedures. Prior to testing, each sample shall be split, making one-half of the samples with proper identification available for testing by the Authorized Officer. Each sample and the results of Purchaser testing shall be made available to the Authorized Officer within 24 hours of sampling. The Purchaser shall provide test results for the first 500 cubic yards produced prior to commencing production crushing and hauling.
- 1008 - If additional binder or filler is necessary in order to meet the grading or plasticity requirements, or for satisfactory bonding of the material, it shall be uniformly blended with the crushed rock material at the crushing and screening plant prior to placing on the road, unless otherwise agreed. The material for such purposes shall be obtained from sources approved by the Authorized Officer and shall be free from stones, vegetative matter, and other deleterious materials.
- 1008a - Each layer of crushed rock material shall be thoroughly mixed on the roadbed by alternately blading, to full depth, until a uniform mixture has been obtained. The mixture shall then be spread to full width. When completed, the spreading shall produce a surface which is smooth, presents uniform shoulder lines, and conforms to the specified cross section.
- 1009 - The roadbed, as shaped and compacted under Sections 300 and 500 of these specifications, shall be approved by the Authorized Officer prior to placement of crushed rock materials. Notification for final inspection prior to rocking shall be 72 hours prior to that inspection and shall be 7 days prior to start of rocking operations.
- 1010 - Crushed rock materials shall be placed and processed on the approved roadbed in accordance with these specifications and conforming to the lines, grades, dimensions, and typical cross sections shown on the plans, and compacted in layers not to exceed 6 inches in depth. When more than one layer is required, each shall be shaped, processed, compacted, and approved by the Authorized officer before the succeeding layer is placed. Irregularities or depressions that develop during compaction of the top layer shall be corrected by loosening the material at these places and adding or removing crushed rock material until the surface is smooth and uniform.
- 1010a - Crushed rock material used to repair or reinforce soft, muddy, frozen, yielding, or rutted roadbed shall not be construed as surfacing under this specification.

AGGREGATE BASE COURSE - 1000
CRUSHED ROCK MATERIAL

- 1012 - Each layer of crushed rock material for base shall be placed, processed, shaped, moistened or dried to uniform moisture content suitable for maximum compaction, and compacted to full width by compaction equipment conforming to the requirements of Subsection 103f and 103i. Minimum compaction shall be deemed adequate when the surface can withstand five passes of a truck, with H-20 loading without appreciable deformation.

AGGREGATE SURFACE COURSE - 1200
CRUSHED ROCK MATERIAL

- 1201 - This work shall consist of furnishing, hauling, and placing one or more layers of crushed rock material on roadbeds and base courses approved for placing crushed rock material in accordance with these specifications and conforming to the dimensions and typical cross sections shown on the plans. Material not conforming to these specifications will be rejected and shall be removed from the road at the purchaser's expense.
- 1202a - Crushed rock materials used in this work may be obtained from commercial sources selected by the Purchaser at his option and expense, providing the rock materials furnished comply with the specifications.
- 1203 - When crushed rock material is produced from gravel, not less than 65 percent by weight of the particles retained on the No. 4 sieve will have 2 manufactured fractured faces. If necessary, to meet the above requirements or to eliminate an excess of filler, the gravel shall be screened before crushing.
- 1204 - Crushed rock material shall consist of hard durable rock fragments conforming to the following gradation requirements:

TABLE 1204

AGGREGATE SURFACE COURSE
CRUSHED ROCK MATERIAL

Percentage by weight passing square mesh sieves
AASHTO T 11 & T 27

GRADATION

Sieve Designation	C	C-1	D	D-1	E	E-1
1-1/2-inch	100	100	-	-	-	-
1-inch	-	-	100	100	-	-
3/4-inch	50-90	60-90	-	70-98	100	100
1/2-inch	-	-	-	-	-	70-98
No. 4	25-50	30-55	30-60	36-60	40-75	44-70
No. 8	-	22-43	-	25-47	-	30-54
No. 30	-	11-27	-	12-31	-	15-34
No. 40	5-25	-	5-30	-	5-35	-
No. 200	2-15	3-15	3-15	3-15	2-15	3-15

AGGREGATE SURFACE COURSE - 1200
CRUSHED ROCK MATERIAL

- 1204a - The Purchaser shall be required to take one sample for each 1,000 cubic yards of crushed rock material to be utilized using AASHTO sampling procedures. The Purchaser shall submit samples to a certified lab or perform testing for gradation requirements using AASHTO T 11 and AASHTO T 27 testing procedures. Prior to testing, each sample shall be split, making one half of the sample, with proper identification, available for testing by the Authorized Officer. Each sample and the results of Purchaser testing shall be made available to the Authorized Officer within 24 hours of sampling. The Purchaser shall provide test results for the first 500 cubic yards produced prior to commencing production crushing and hauling.
- 1205 - Crushed rock material shall not exceed 35 percent loss as determined by AASHTO T 96.
- 1206 - Crushed rock material shall show a durability value of not less than 35 as determined by AASHTO T210.
- 1208 - If additional binder or filler material is necessary to meet the grading or plasticity requirements or for satisfactory bonding of the material, it shall be uniformly blended with the crushed rock material at the crushing and screening plant prior to placing on the road, unless otherwise agreed. The material for such purposes shall be obtained from sources approved by the Authorized Officer and shall be free from stones, vegetative matter, and other deleterious materials.
- 1208a - Each layer of crushed rock material shall be thoroughly mixed on the roadbed by alternately blading, to full depth, until a uniform mixture has been obtained. The mixture shall then be spread to full width. When completed, the spreading shall produce a surface which is smooth, presents uniform shoulder lines, and conforms to the specified cross section.
- 1209 - Shaping and compacting of roadbed and base course shall be completed and approved, prior to placing crushed rock material, in accordance to the requirements of Subsections 300 and 500 for placing on the roadbed and landings and Subsection 1000 for placing on the base course. Notification for final inspection prior to rocking shall be 7 days prior to the inspection and shall be 10 days prior to start of surfacing operations.

AGGREGATE SURFACE COURSE - 1200
CRUSHED ROCK MATERIAL

- 1210 - Crushed rock material conforming to the requirements of these specifications shall be placed on the approved roadbed, landings, and base course in accordance with these specifications and conforming to the lines, grades, dimensions, and typical cross sections shown on the plans. Compacted layers shall not exceed 4 inches in depth. When more than one layer is required, each shall be shaped, processed, compacted, and approved by the Authorized Officer before the succeeding layer is placed. Irregularities or depressions that develop during compaction of the top layer shall be corrected by loosening the material at these places and then adding or removing crushed rock material until the surface is smooth and uniform.
- 1210a - Crushed rock material used to repair or reinforce soft, muddy, frozen, yielding, or rutted roadbed shall not be construed, as surfacing required by this specification.
- 1212 - Each layer of crushed rock material placed, processed, and shaped as specified shall be moistened or dried to a uniform moisture content suitable for maximum compaction and compacted to full width by compacting equipment conforming to the requirements of Subsection 103f. Minimum compaction shall be 1 hour of continuous compacting for each 6 stations, or fraction thereof.

EROSION CONTROL - 1700

- 1701 - This work shall consist of measures to control soil erosion or water pollution during the construction operation through the use of berms, dikes, dams, sediment basins, fiber mats, netting, gravel, mulches, grasses, slope drains and other erosion control devices or methods in accordance with these specifications and conforming to the lines, grades, dimensions and typical cross sections shown on the plans.
- 1704 - The erosion control provisions specified under this Subsection shall be coordinated with the Soil Stabilization requirements of section 1800.
- 1705 - The surface area of erodible earth material exposed at any one time by clearing and grubbing shall not exceed 4000 square feet after September 15, without prior approval by the Authorized Officer.
- 1706 - The surface area of erodible earth material exposed at one time by excavation, borrow, or fill within the right-of-way shall not exceed 4000 square feet after September 15, without prior approval by the Authorized Officer.

EROSION CONTROL - 1700

- 1712 - The Purchaser shall provide erosion control measures for reconstructed ditches on steep grades which includes but is not limited to, dumped stone, jute mesh, sod, or check dams consisting of stone. Width of protective lining or dam should extend far enough up the ditch slopes to effectively contain the runoff and prevent erosion and washout at the edges and prevent sediment from reaching live water.

SOIL STABILIZATION - 1800

- 1801 - This work shall consist of seeding and mulching on designated cuts, fills, borrow sites, disposal sites, special areas, and any other disturbed areas in accordance with these specifications and as shown on the plans. This work is required for road acceptance under Section 18 of this contract.
- 1802 - Soil stabilization work consisting of seeding and mulching shall be performed on existing roads and designated locations in accordance with these specifications, at the following locations:

SOIL STABILIZATION - 1800

- 1803 - Soil stabilization work as specified under Subsections 1802 shall be performed during the following seasonal periods:

From: April 15	To: May 15
From: September 30	To: October 31

The Authorized Officer may modify the above seasonal dates to conform to existing weather conditions and changes in the construction schedule.

- 1804 - The Purchaser shall furnish the following species of grass seed meeting corresponding germination, purity, and weed-content requirements:

Species	Germination Min. %	Purity Min. %	Crop and Weed Content Max. %	Noxious Weed Content Max %
Red Fescue	85%	97%	0%	0%

Furnished seed shall meet or exceed the factors in the above table. Furnished seed shall be sown at a rate equal to 10 pounds per acre. Prior to applying seed, the contractor will supply the BLM with the seed label showing testing results.

If seed is not available that meets the factors in the above table, the project area would be sown with seed approved by the resource area botanist. Prior to applying seed, the contractor will supply the BLM with the seed label showing testing results.

- 1806a - Additional soil stabilization work consisting of seeding and mulching, may be required at the option of the Authorized Officer. Providing the additional stabilization is not due to Purchaser negligence as specified in Sec. 12 of the contract, a reduction in the total purchased price shall be made to offset the cost of furnishing and applying such additional stabilization material. Cost shall be based upon the unit price set forth in the current BLM Timber Appraisal Production Cost Schedule.
- 1808 - Mulch materials conforming to the requirements of Subsections 1808a shall be furnished by the Purchaser and applied in accordance with Subsection 1812.
- 1808a - Straw mulch shall be certified weed free from commercial grain fields and native grass fields. Straw mulch shall be from oats, wheat, rye, or other approved grain crops which are free from mold, or other objectionable materials. Straw mulch shall be in an air-dry condition and suitable for placement.

SOIL STABILIZATION - 1800

- 1809 - Mulch material shall be delivered to the work area in a dry state. Material found to be wet will not be accepted. Material to be used in the mulching operation may be stockpiled along the road designated for treatment provided that it is maintained in a dry state and has the approval of the Authorized Officer.
- 1810 - Bulk mulching material required under these specifications shall be delivered to the work area bound either by twine, string or hemp rope. Wire binding will not be permitted.
- 1814 - The Purchaser may reduce the application rate on partially covered slopes and refrain from application on areas already well stocked with grass, or on rock surfaces, as determined by the Authorized Officer.
- 1815 - The seed and mulch materials shall be placed by the dry method in accordance with the requirements set forth in Subsection 1815b.
- 1815b - Dry Method - Blowers, mechanical seeders, seed drills, landscape seeders, cultipaker seeders, fertilizer spreaders or other approved mechanical seeding equipment may be used when seed and fertilizer are to be applied in dry form.
- 1818 - At the beginning of each day's operation, a measured area will be seeded and mulched to assure uniform application.
- 1819 - The maximum distance to be seeded and mulched from the road centerline shall be 100 feet for the cut slopes and 150 feet for the fill slopes.
- 1820 - The Purchaser shall notify the Authorized Officer at least 3 days in advance of date he intends to commence the specified soil stabilization work.
- 1822 - Mulch that collects at the end of culverts or accumulates to excessive depths on the slopes shall be evenly spread by hand methods, as directed by the Authorized Officer.
- 1823 - No materials shall be applied when wind velocities would prevent a uniform application of the mix or slurry or when winds would drift the mix or slurry spray outside of the designated treatment area.
- 1826 - Twine, rope, sacks, and other debris resulting from the soil-stabilization operation shall be picked up and disposed of to the satisfaction of the Authorized Officer.

ROADSIDE BRUSHING - 2100

- 2101 - This work shall consist of the removal of vegetation from the road prism - variable distance, and inside curves in accordance with these specifications and conforming to the lines, grades, dimensions, and typical cross sections shown on the Roadside Brushing Detail Sheet of this exhibit, at designated locations as shown in the plans.
- 2102 - Roadside brushing may be performed mechanically with self powered, self-propelled equipment or manually with hand tools, including chain saws.
- 2103 - Vegetation, cut manually or mechanically, less than 6 inches in diameter at D.B.H.O.B., shall be cut to a maximum height of 3 inches above the ground surface or above obstructions such as rocks or stumps, on cut and fill slopes. All limbs below the 3 inch area will be severed from the trunk.
- 2103a - Vegetation shall be cut and removed from the road bed between the outside shoulders and the ditch centerline and such vegetation shall be cut to a maximum height of 1 inch above the ground and running surface. Limbs below the 1 inch area will be severed from the trunk. Sharp pointed ends will not be permitted. Cuts shall be parallel to the ground line or running surface.
- 2104 - Trees in excess of 6 inches in diameter at D.B.H.O.B. shall be limbed, so that no limbs extend into the treated area or over the roadbed to a height of 14 feet above the running surface of the roadway on cut and fill slopes, within the road prism-variable distance. Limbs shall be cut to within 1 inch of the trunk to produce a smooth vertical face. Removal of trees larger than 6 inches in diameter for sight distance or safety may be directed by the Authorized Officer.
- 2105 - Vegetation that is outside of the road prism-variable distance that protrudes into the road prism and within 14 feet in elevation above the running surface shall be cut, to within 1 inch of the trunk to produce a smooth vertical face.
- 2106 - Vegetative growth capable of growing 1 foot in height or higher shall be cut, within the road prism-variable distance or as directed by the Authorized Officer.
- 2107 - Inside curves shall be brushed out for a sight distance of 200 feet chord distance or a middle ordinate distance of 25 feet whichever is achieved first. Overhanging limbs and vegetation in excess of 1 foot in height shall be cut within these areas.
- 2108 - Self-propelled equipment shall not be permitted on cut and fill slopes or in ditches.

ROADSIDE BRUSHING - 2100

2109 - Debris resulting from this operation shall be scattered downslope from the roadway. Debris shall not be allowed to accumulate in concentrations. Debris in excess of 1 foot in length and 2 inches in diameter shall not be allowed to remain on cut slopes, ditches, roadways or water courses, or as directed by the Authorized Officer.

2112 - Roadside brushing shall be accomplished as shown on the plans and as listed below:

Road No.	From Sta./M.P.	To Sta./M.P.
6-3E-30.0	0.0 mile	3.00 mile
6-3E-31.0	0.0 mile	2.50 mile
7-3E-5.05	0.00 mile	0.10 mile
7-3E-5.1	0.00 mile	0.56 mile
7-3E-5.2	0.00 mile	0.16 mile
7-3E-5.3	0.00 mile	0.10 mile
7-3E-5.0	0.00 mile	0.46 mile
7-3E-8.4	0.00 mile	0.15 mile
7-3E-8.5	0.00 mile	0.09 mile
7-3E-8.6	0.00 mile	0.06 mile
7-3E-8.7	0.00 mile	0.14 mile
7-3E-8.8	0.00 mile	0.34 mile
7-3E-9.3	0.00 mile	0.41 mile
7-3E-9.4	0.00 mile	0.08 mile

ROADSIDE BRUSHING - 2100

- 2115 - Mechanical brush cutters shall not be operated when there are people and occupied vehicles within 400 feet of the immediate operating area.
- 2116 - Traffic warning signs shall be required at each end of the work area. Signs shall meet the requirements of the Manual on Uniform Traffic Control Devices.

ROAD RENOVATION WORKLIST

Work to be Accomplished

Road renovation as required under Exhibit C of this contract shall include, but is not limited to the following worklist. Any soils left exposed after renovation or new construction activities shall be seeded and mulched. Roadside tree removal shall be accomplished prior to culvert installations and aggregate placement. Roadside trees shall not be felled onto existing roads. Processing shall not be accomplished on top of existing aggregate surfaces. Logging slash and log decks shall not be placed in ditches, in catch basins, or on top of outlets of culverts.

Road No. 6-3E-30.0

MP

- 0.06 - Begin renovation work as described in Sections 150, 500, and this worklist. Soil stabilization and erosion control measures will be required as necessary and as described in Sections 1700 and 1800. Begin mechanical brushing, blading and compaction. Begin placement of 3” and 1.5” of allocated spot rock aggregate where necessary and appropriate to sustain haul traffic.
- 3.00 - End of blading, compaction, and mechanical brushing.
- 6.84 - End of renovation.

Road No. 6-3E-31.0

MP

- 0.00 - Begin renovation work as described in Sections 150, 500, and this worklist. Soil stabilization and erosion control measures will be required as necessary and as described in Sections 1700 and 1800. Begin placement of 3” of allocated spot rock aggregate where necessary and appropriate to sustain haul traffic.
- 2.50 - End of renovation.

Road No. 5-3E-5.0

MP

- 0.00 - Begin renovation work as described in Sections 150, 500, and this worklist. Soil stabilization and erosion control measures will be required as necessary and as described in Sections 1700 and 1800. Begin placement of 3” and 1.5” of allocated spot rock aggregate where necessary and appropriate to sustain haul traffic.
- 0.46 - End of renovation.

Road No. 5-3E-5.05

MP

- 0.00 - Begin renovation work as described in Sections 150, 500, and this worklist. Soil stabilization and erosion control measures will be required as necessary and as described in Sections 1700 and 1800.
- 0.10 - End of renovation.

Road No. 5-3E-5.1

MP

- 0.00 - Begin renovation work as described in Sections 150, 500, and this worklist. Soil stabilization and erosion control measures will be required as necessary and as described in Sections 1700 and 1800.
- 0.56 - End of renovation.

Road No. 5-3E-5.2

MP

- 0.00 - Begin renovation work as described in Sections 150, 500, and this worklist. Soil stabilization and erosion control measures will be required as necessary and as described in Sections 1700 and 1800.
- 0.16 - End of renovation.

Road No. 5-3E-5.3

MP

- 0.00 - Begin renovation work as described in Sections 150, 500, and this worklist. Soil stabilization and erosion control measures will be required as necessary and as described in Sections 1700 and 1800.
- 0.20 - End of renovation.

Road No. 7-3E-7.0

MP

- 0.00 - Begin renovation work as described in Sections 150, 500, and this worklist. Soil stabilization and erosion control measures will be required as necessary and as described in Sections 1700 and 1800. Begin placement of 3” of allocated spot rock aggregate where necessary and appropriate to sustain haul traffic at junction with South Molalla Road.
- 1.72 - End of renovation of 7-3E-7.0 road at junction with 7-3E-8.7 road to right.

Road No. 7-3E-8.0

MP

- 0.00 - Begin renovation work as described in Sections 150, 500, and this worklist. Soil stabilization and erosion control measures will be required as necessary and as described in Sections 1700 and 1800. Begin placement of 3” of allocated spot rock aggregate where necessary and appropriate to sustain haul traffic at junction with 6-3E-30.0.
- 1.91 - End of renovation.

Road No. 7-3E-8.4

MP

- 0.00 - Begin renovation work as described in Sections 150, 500, and this worklist. Soil stabilization and erosion control measures will be required as necessary and as described in Sections 1700 and 1800. Begin placement of 3” of allocated spot rock aggregate where necessary and appropriate to sustain haul .
- 0.15 - End of renovation.

Road No. 7-3E-8.5

MP

- 0.00 - Begin renovation work as described in Sections 150, 500, and this worklist. Soil stabilization and erosion control measures will be required as necessary and as described in Sections 1700 and 1800. Begin placement of 3” of allocated spot rock aggregate where necessary and appropriate to sustain haul traffic.
- 0.09 - End of renovation.

Road No. 7-3E-8.6

MP

- 0.00 - Begin renovation work as described in Sections 150, 500, and this worklist. Soil stabilization and erosion control measures will be required as necessary and as described in Sections 1700 and 1800.
- 0.06 - End of renovation.

Road No. 7-3E-8.7

MP

- 0.00 - Begin renovation work as described in Sections 150, 500, and this worklist. Soil stabilization and erosion control measures will be required as necessary and as described in Sections 1700 and 1800. Begin placement of 3" of allocated spot rock aggregate where necessary and appropriate to sustain haul traffic.
- 0.14 - End of renovation.

Road No. 7-3E-8.8

MP

- 0.00 - Begin renovation work as described in Sections 150 and 500. Begin rocking application as described in Sections 150, 1000, and 1200. Soil stabilization and erosion control measures will be required as necessary and as described in Sections 1700 and 1800. Begin placement of 3" of allocated spot rock aggregate where necessary and appropriate to sustain haul traffic.
- 0.38 - End of renovation.

Road No. 7-3E-9.3

MP

- 0.00 - Begin renovation work as described in Sections 150 and 500. Begin rocking application as described in Sections 150, 1000, and 1200. Soil stabilization and erosion control measures will be required as necessary and as described in Sections 1700 and 1800. Begin placement of 3" of allocated spot rock aggregate where necessary and appropriate to sustain haul traffic.
- 0.41 - End of renovation.

Road No. 7-3E-9.4

MP

- 0.00 - Begin renovation work as described in Sections 150 and 500. Begin rocking application as described in Sections 150, 1000, and 1200. Soil stabilization and erosion control measures will be required as necessary and as described in Sections 1700 and 1800. Begin placement of 3” of allocated spot rock aggregate where necessary and appropriate to sustain haul traffic.

- 0.08 - End of renovation.

U.S. DEPT. OF THE INTERIOR
Bureau of Land Management

NORTHWEST OREGON DISTRICT

**ROADSIDE BRUSHING
DETAIL SHEET**

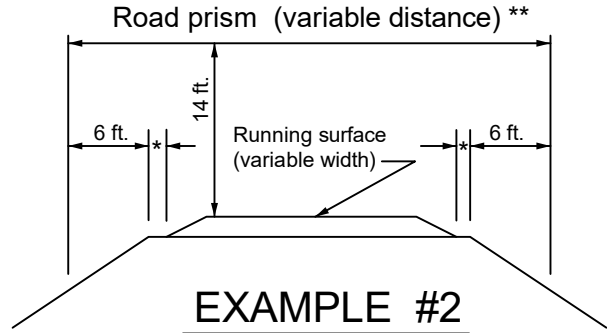
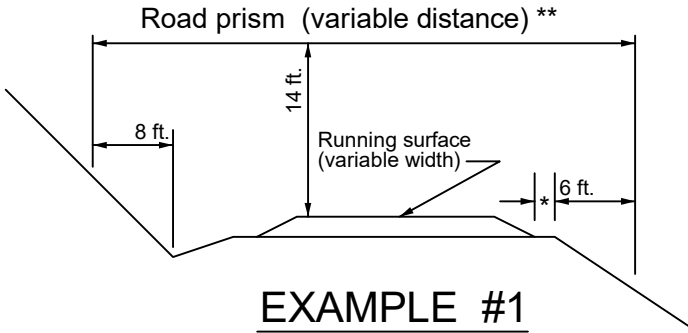

(NO SCALE)

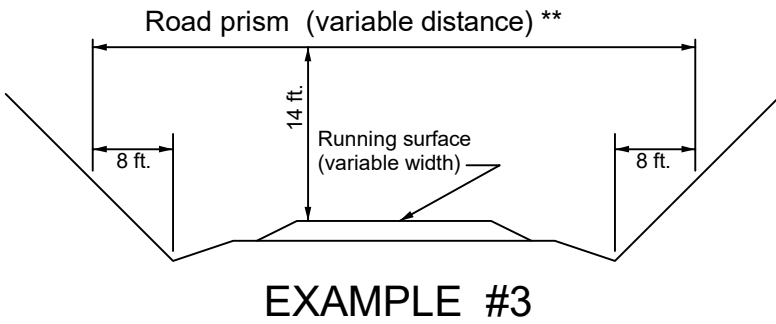

* Variable distance between running surface and start of fill slope.

** All areas within the variable distance shall be free of all vegetation capable of growing one (1) foot in height or higher and all overhanging limbs and branches 14 feet in elevation above the running surface.

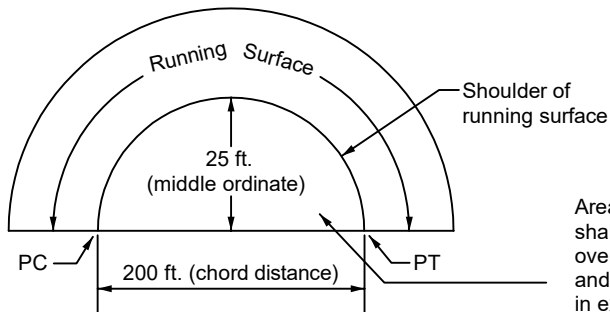

SIGHT DISTANCE DIAGRAM

Area to be cut:
shall be free of
overhanging limbs
and all vegetation
in excess of 1 foot
in height.

NOTE:

Prior to beginning roadside brushing the purchaser shall establish a control section in a location determined by the Authorized Officer. This section will be used to physically and visually establish acceptable cutting and cleanup standards to be used for the remaining roadside brushing.



UNITED STATES DEPARTMENT OF THE INTERIOR
Bureau of Land Management
Road Plan Map

Pine Crest DTR Reoffer
ORNO1-TS-2022.0111
EXHIBIT C

T. 6 S., R. 3 E., sections 30, 31, 32 and T. 7 S., R. 3 E., sections 4, 5, 6 W.M.

Sheet 37 of 38

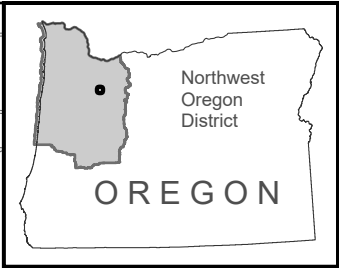
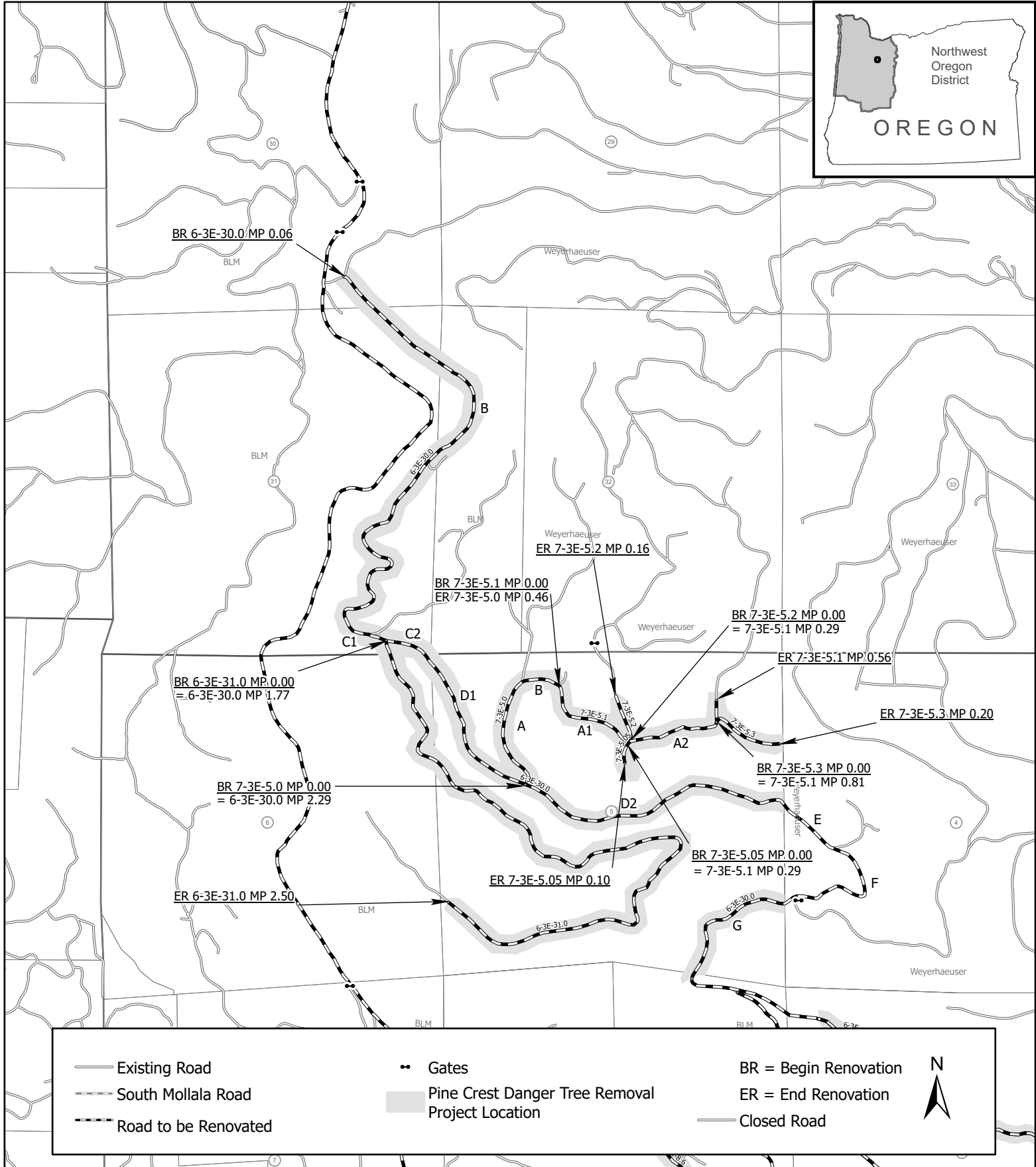

Existing Road	Gates	BR = Begin Renovation	
South Mollala Road	Pine Crest Danger Tree Removal Project Location	ER = End Renovation	
Road to be Renovated		Closed Road	

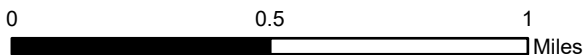

No warranty is made by the Bureau of Land Management as to the accuracy, reliability or completeness of these data for individual use or aggregate use with other data. Original Data was compiled from multiple source data and may not meet U.S. National Mapping Accuracy Standard of the Office of Management and Budget, 6/9/2022.



UNITED STATES DEPARTMENT OF THE INTERIOR
Bureau of Land Management

Road Plan Map

T. 7 S., R. 3 E., Sections 4, 5, 7, 8, 9, 10 W.M.

Pine Crest DTR
ORNO1-TS-2022.0111
EXHIBIT C

Sheet 38 of 38

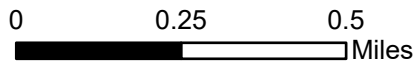
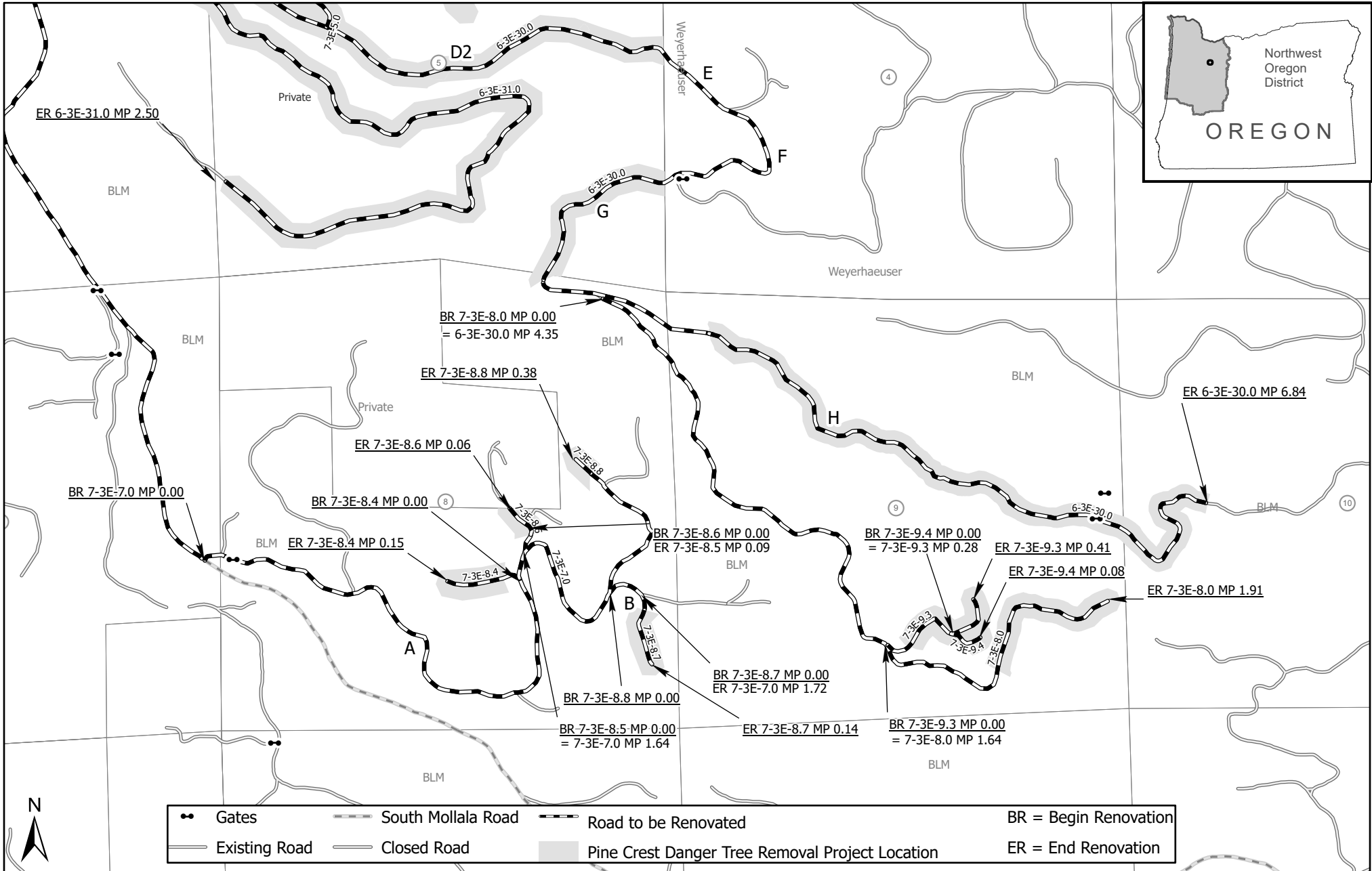

No warranty is made by the Bureau of Land Management as to the accuracy, reliability or completeness of these data for individual use or aggregate use with other data. Original Data was compiled from multiple source data and may not meet U.S. National Mapping Accuracy Standard of the Office of Management and Budget. 6/9/2022

United States
Department of the Interior
Bureau of Land Management
Northwest Oregon District

Timber Sale Contract
Purchaser Road Maintenance Specifications

SECTION	SHEET	DESCRIPTION
	1	Table of Contents
3000	2	General
3100	2-4	Operational Maintenance
3200	4-5	Seasonal Maintenance
3300	5	Final Maintenance
3400	6	Other Maintenance

ROAD MAINTENANCE SPECIFICATIONS

GENERAL - 3000

- 3001 The Purchaser shall be required to maintain all roads listed and/or referenced in Sec. 42. Special Provisions, and as shown on the Exhibit E map of this contract in accordance with Sections 3000, 3100, 3200, 3300 and 3400 of this Exhibit.
- 3002 The Purchaser shall maintain the cross section of existing dirt or graveled roads to the existing geometric standards. Any roads required to be constructed, improved, or renovated under the terms of this contract shall be maintained to the geometric standards required in Exhibit C of this contract.
- 3003 The minimum required maintenance on any roads shall include the provisions specified in Subsections 3101, 3104, and 3105.
- 3004 The Purchaser shall be responsible for providing timely maintenance and cleanup on any roads with logging units substantially completed, prior to moving operations to other roads, unless otherwise permitted by the Authorized Officer. The maximum length of non-maintained or non-cleanup of the road prism shall not exceed the sum of one (1) mile at any time. Release of maintenance requirements may be granted, upon written request, when the conditions specified in Sections 3300 and 3400 are met satisfactorily.

OPERATIONAL MAINTENANCE - 3100

- 3101 The Purchaser shall blade and shape the road surface and shoulders with a motor grader. Banks shall not be undercut. Back blading with tractors or similar equipment will be allowed only around landings and other areas when approved by the Authorized Officer.
- 3102 The Purchaser shall furnish and place a minimum of 800 cubic yards of aggregate conforming to the requirements in Section 1000 of Exhibit C of this contract on the roadway and landings at locations and in the amounts designated by the Authorized Officer. The aggregate gradation and compacted depth will also be designated by the Authorized Officer. This aggregate shall be used to repair surface failures, landings and areas of depleted surface depth excluding damages covered by Section 12 of this contract. The aggregate shall be furnished, hauled, placed, spread, and compacted by use of dump trucks, water trucks, and motor grader or similar equipment.

OPERATIONAL MAINTENANCE - 3100

- 3103 The purchaser shall maintain established berms and place additional berms using adjacent material where needed to protect fills as directed by the Authorized Officer.
- 3104 The purchaser shall perform other road cleanup including removal of debris, fallen timber, bank slough, and slides which can practicably be accomplished by a motor grader, rubber tired front end bucket loader, rubber-tired backhoe or comparable equipment, and by the use of hand tools.
- 3104a Removal of bank slough and slide material includes placement of material at the nearest designated, suitable disposal site where material cannot erode into streams, lakes, or reservoirs or cause undue damage to road fill slopes which have been planted or mulched to control soil erosion as directed by the Authorized Officer.
- 3104b The Purchaser shall be responsible for removal of all slides or slough, up to fifteen station yards in quantity, at any one site. This work includes unlimited multiple sites on all roads required to be maintained by the Purchaser.
- Prior to removal of any slough or slide material exceeding fifteen station yards at any one site, the Purchaser and the Authorized Officer or their Authorized Representatives shall agree in writing, in the field, to the quantity of material, method of disposal, and the disposal site. Work may commence immediately after agreement.
- Upon completion of agreed upon work, a reduction in timber sale purchase price will be made to offset the cost of the work, based on current BLM Road Cost Guide. Adjustments in purchase price for completed work shall be made as necessary and no less than one per year when actual work is ongoing.
- 3105 The Purchaser shall be responsible for maintaining normal flow in drainage structures. This includes cleaning out drainage ditches, catch basins, clearing pipe inverts of sediment and other debris lodged in the barrel of the pipe, and maintaining water dips and water bars using equipment specified in Subsection 3104 and other culvert cleaning and flushing equipment.

OPERATIONAL MAINTENANCE - 3100

3106 The Purchaser shall be responsible for repair and replacement of all materials eroded from road shoulders and fill slopes, up to fifteen station yards in quantity, at any one site. This work includes unlimited multiple sites on all roads required to be maintained by the Purchaser. Prior to repair and replacement of eroded material exceeding fifteen station yards at any one site, the Purchaser and the Authorized Officer or their Authorized Representatives shall agree in writing, in the field, to the quantity of material, borrow source and method of repair. Work may commence immediately after agreement.

Upon completion of agreed upon work, a reduction in timber sale purchase price will be made to offset the cost of the work based upon current BLM Road Cost Guide. Adjustments in purchase price for completed work shall be made as necessary, and no less than once per year when actual work is ongoing.

3107 The Purchaser shall cut or trim trees and brush which obstructs vision or prevents the safe passage of traffic along the traveled way when directed by the Authorized Officer.

The Purchaser shall also cut trees or brush encroaching on the road prism that are a result of his activities or winter damage during the contract period. Disposal of such vegetative material shall be by scattering below the road.

3108 The Purchaser shall avoid fouling gravel or bituminous surfaces through covering with earth and debris from side ditches, slides or other sources. The Purchaser shall also avoid blading surfacing material off the running surface of the roadway. Skidding of logs on the roadway in or outside designated logging units is not authorized without prior written approval by the Authorized Officer. Repair required caused by such skidding activity is not considered maintenance and shall be repaired at the Purchaser's expense.

SEASONAL MAINTENANCE - 3200

3201 The Purchaser shall perform preventative maintenance at the end of Purchaser's hauling each season and during non-hauling periods which occur between other operations on the contract area. This includes requirements specified in Section 3100.

SEASONAL MAINTENANCE - 3200

3202 The purchaser shall perform, and complete maintenance specified in Sections 3000, 3100, and 3200 on all roads maintained by purchaser, prior to October 31 each year, except as specified in Subsection 3203, after initial commencement of construction or logging operations. Thereafter, all roads shall have continuous preventive maintenance and road cleanup until suspension of seasonal operations. This includes all roads used and not used during the proceeding operating seasons.

3203 The Purchaser shall complete road cleanup and maintenance, as specified in Section 3100, at the completion of logging operations on any roads located in an area separate from the area where logging activities will resume.

3204 The Purchaser shall be responsible for performing post storm inspections and maintenance during the winter season to minimize erosion and potential road or watershed damage.

FINAL MAINTENANCE - 3300

3301 The Purchaser shall complete final maintenance and/or damage repairs on all roads used under the terms of their contract within thirty (30) calendar days following the completion of hauling and in accordance with Sec. 16 (b) of this contract. This work shall include any maintenance and/or damage repairs specified in Sections 3000, 3100, and 3200 necessary to meet the conditions specified in Subsection 3002 and shall be executed in accordance with Subsection 3302 of this section.

The Authorized Officer may grant acceptance of Purchaser's maintenance responsibility in part where certain individual roads or road segments are no longer of any use to the Purchaser's remaining removal operations, providing that all contract requirements as specified under Sec. 16(b), Special Provisions, Sections 3000, 3100, 3200 and 3300 of the maintenance specifications have been completed and a relinquishment of cutting and removal rights on cutting units tributary to these roads is signed by the Purchaser. Request for partial acceptance must be submitted in writing by the Purchaser.

3302 The Purchaser shall perform final road maintenance only when weather or soil moisture conditions are suitable for normal maintenance equipment operations as determined by the Authorized Officer.

If final maintenance is delayed after the date required in Subsection 3301 of this contract by adverse soil moisture or unsuitable equipment operating conditions, the Purchaser will be notified by the Authorized Officer when soil moisture and equipment operating conditions are suitable. The Purchaser shall then be required to complete final maintenance within 30 days.

OTHER MAINTENANCE - 3400

3401 The Purchaser shall repair any damage to road surfaces that was specified under Subsection 3108. This repair includes restoring the roadway to the designed standard and replacement of surfacing with approved surface material. This repair is not limited to use of equipment specified in Subsection 3104.

3402 The Purchaser shall be permitted to remove ice and snow from roads authorized for use under this contract only when prior written approval has been secured from the Authorized Officer. The Purchaser shall submit a written request for permission to remove ice and snow in advance of the date operations are to begin.

Upon receiving written authorization for ice or snow removal, the Purchaser will perform the work according to the conditions and equipment requirements set forth in the authorization.



UNITED STATES DEPARTMENT OF THE INTERIOR
Bureau of Land Management
Road Use and Maintenance Map

Pine Crest DTR Reoffer
ORN01-TS-2022.0111
EXHIBIT E

T 6S R3E sections 30, 31, 32 and T 7S R3E sections 5, 6, 8, 9, 10 W.M.

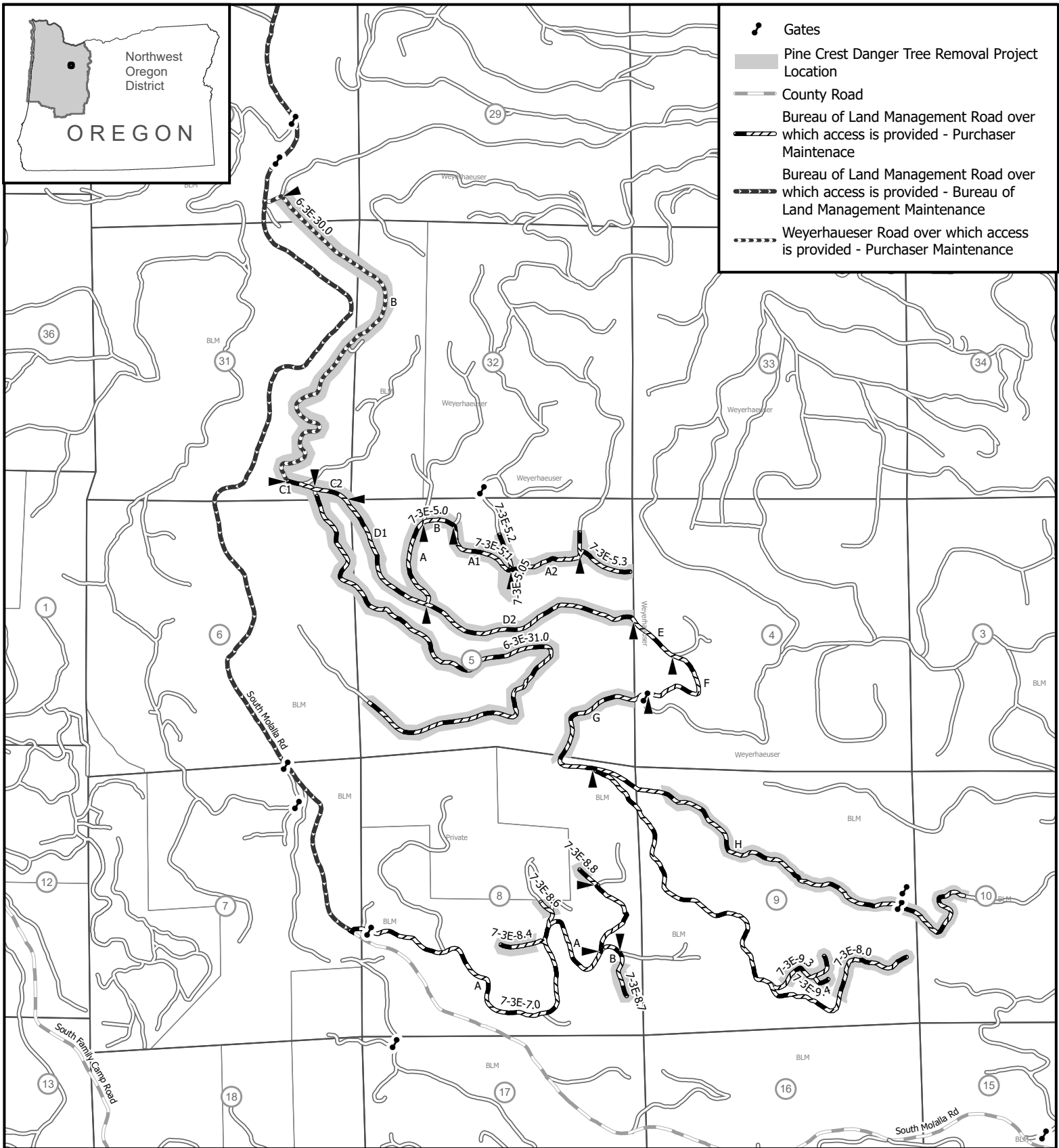

- Gates
- Pine Crest Danger Tree Removal Project Location
- County Road
- Bureau of Land Management Road over which access is provided - Purchaser Maintenance
- Bureau of Land Management Road over which access is provided - Bureau of Land Management Maintenance
- Weyerhaeuser Road over which access is provided - Purchaser Maintenance

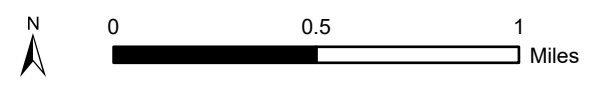
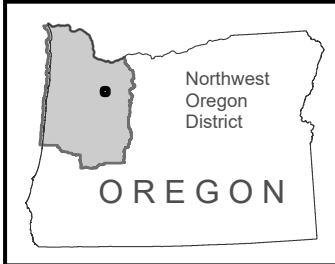

No warranty is made by the Bureau of Land Management as to the accuracy, reliability or completeness of these data for individual use or aggregate use with other data. Original Data was compiled from multiple source data and may not meet U.S. National Mapping Accuracy Standard of the Office of Management and Budget. 6/9/2022



United States Department of the Interior - BUREAU OF LAND MANAGEMENT

Pine Crest DTR Reoffer Vicinity Map

T 6S R3E sections 30, 31, 32 and T 7S R3E sections 5, 6, 8, 9, 10

NORTHWEST OREGON DISTRICT



5/31/2022

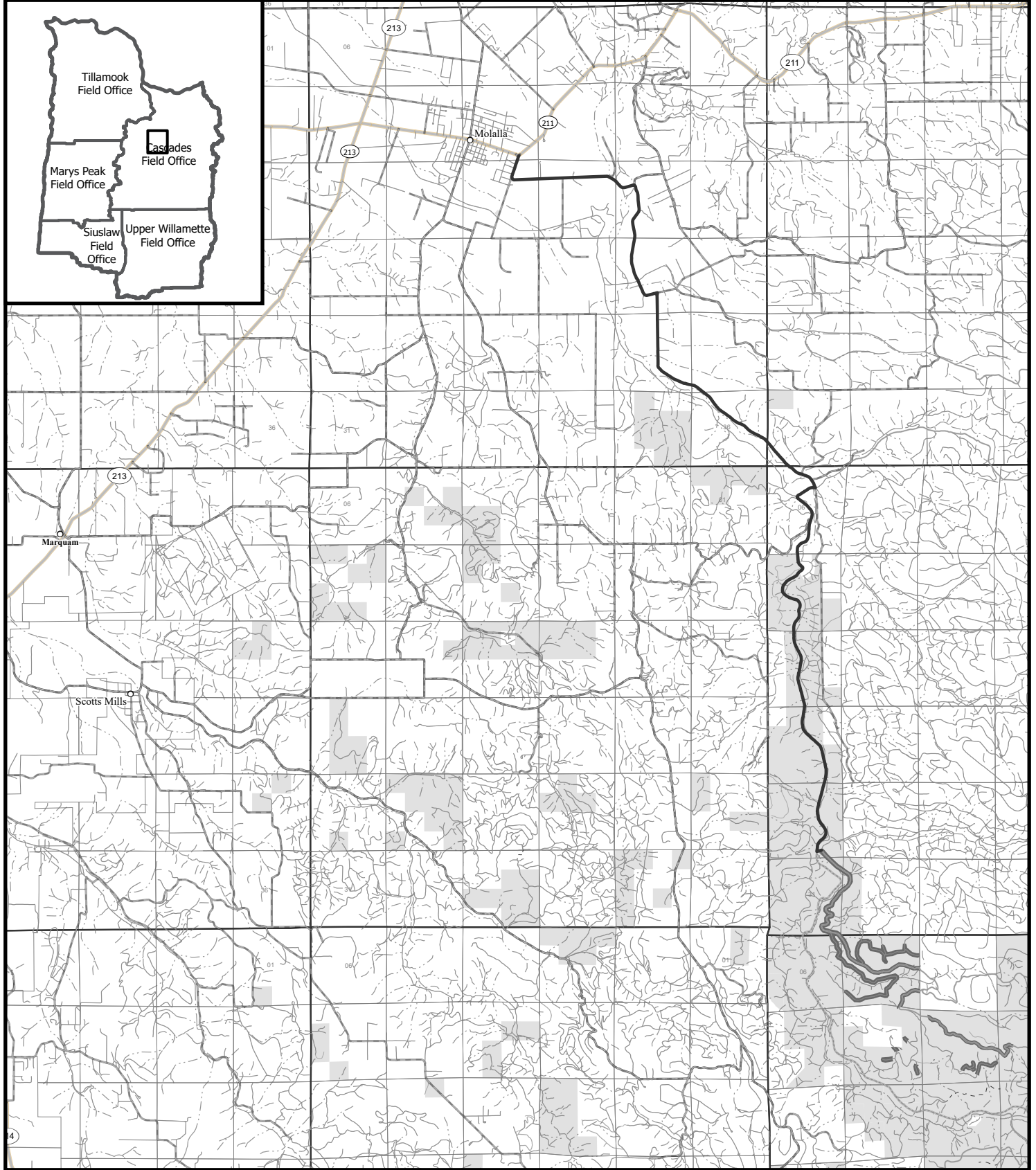

State Highway	County Road	Haul Route	Pine Bear Danger Tree Removal Project Location	 0 0.5 1 2 Miles	 N
Stream	Existing Road	Bureau of Land Management			

No warranty is made by the Bureau of Land Management as to the accuracy, reliability, or completeness of these data for individual or aggregate use with other data. Original data were compiled from various sources and may be updated without notification.

Legal Description of Contract Area

Land Status	County	Township	Range	Section	Subdivision	Meridian
O&C	Clackamas	6S	3W	30	N1/2 SE1/4	Willamette
O&C	Clackamas	6S	3W	31	E1/2 NE1/4, E1/2 SE1/4, SW1/4 SE1/4	Willamette
O&C	Clackamas	6S	3W	32	W1/2 NW1/4	Willamette
O&C	Clackamas	7S	3W	5	Lot 1, 2, 3, 4, 5, 6, 7, 8, 9, 10, 11, 12, N1/2 NE1/4, N1/2 NW1/4	Willamette
O&C	Clackamas	7S	3W	6	Lot 1, SE1/4, NE1/4	Willamette
O&C	Clackamas	7S	3W	8	Lot 1, SE1/4 NE1/4, NE1/4 SW1/4, E1/2 SE1/4	Willamette
O&C	Clackamas	7S	3W	9	Lot 3, 4, 5, 6, 7, 8, 10, 11, NW1/4 NW1/4	Willamette
O&C	Clackamas	7S	3W	10	Lot 1, 8,	Willamette

Species Totals

Species	Net	Gross Merch	Gross	# of Merch Logs	# of Cull Logs	# of Trees
Douglas Fir	3,306.0	3,735.0	3,901.0	29,092	4,959	5,950
Western Hemlock	34.0	37.0	48.0	428	54	225
Totals	3,340.0	3,772.0	3,949.0	29,520	5,013	6,175

Cutting Area Acres

Regeneration Harvest Acres	Partial Cut Acres	Right of Way Acres	Total Acres	Net Volume per Acre
333.0	0.0	0.0	333.0	10.0

Logging Costs

Stump to Truck	\$876,239.32
Transportation	\$271,584.00
Road Construction	\$52,150.32
Maintenance/Rockwear	\$26,282.31
Road Use	\$0.00
Other Allowances	\$63,204.12
Total:	\$1,289,460.07
Total Logging Cost per MBF:	\$386.07

Utilization Centers

<u>Location</u>	<u>Distance</u>	<u>% of Net Volume</u>
Salem OR	60.0 miles	100 %

Profit & Risk

Profit	8 %
Risk	3 %
Total Profit & Risk	11 %

Tract Features

Quadratic Mean DBH	21.2 in
Average GM Log	134 bf
Average Volume per Acre	10.0 mbf
Recovery	84 %
<u>Net MBF volume:</u>	
Green	0.0 mbf
Salvage	3,340 mbf
Export	0 mbf
<u>Ground Base Logging:</u>	
Percent of Sale Volume	74 %
Average Yarding Slope	30 %
Average Yarding Distance	100 ft
<u>Cable Logging:</u>	
Percent of Sale Volume	26 %
Average Yarding Slope	45 %
Average Yarding Distance	100 ft
<u>Aerial Logging:</u>	
Percent of Sale Volume	0 %
Average Yarding Slope	0 %
Average Yarding Distance	0 ft

Cruise

Cruise Completed	March 2022
Cruised By	Brian Barclay
Cruise Method	Ocular estimation of volume combined with Variable Plot cruise used for volume determination.

Stumpage Computation

Species	# of Trees	Net Volume	Pond Value	(-) Profit & Risk	(-) Logging Costs	(+) Marginal Log Value	Appraised Price/MBF	Appraised Value
Douglas Fir	5,950	3,306.0	\$548.26	\$60.31	\$386.07	\$0.00	\$101.90	\$336,881.40
Western Hemlock	225	34.0	\$272.38	\$29.96	\$386.07	\$0.00	\$27.30 *	\$928.20
Totals	6,175	3,340.0						\$337,809.60

* Minimum Stumpage values were used to compute the Appraised Price/MBF (10% of Pond Value)

Other Wood Products

Product	Unit of Measure	# of Units	\$/Unit	Appraised Value
Biomass	Green Tons	1	\$5.00	\$5.00
Totals				\$5.00

Total Appraised Value: \$337,814.60

Percent of Volume By Log Grade

Species	No. 1 & 2 Peeler	No. 3 Peeler	Special Mill	No. 2 Sawmill	No. 3 Sawmill	No. 4 Sawmill	Camp Run
Douglas Fir				75.0 %	24.0 %	1.0 %	

Species	Peeler	No. 1 Sawmill	Special Mill	No. 2 Sawmill	No. 3 Sawmill	No. 4 Sawmill	Camp Run
Western Hemlock				76.0 %	20.0 %	4.0 %	

Unit: 1

Species	Net	Gross Merch	Gross	# of Trees
Douglas Fir	2,316.0	2,618.0	2,731.0	4,165
Western Hemlock	23.0	25.0	28.0	155
Totals:	2,339.0	2,643.0	2,759.0	4,320

Net Volume/Acre: 9.9 MBF

Regeneration Harvest	236.0
Partial Cut	0.0
Right of Way	0.0
Total Acres:	236.0

Unit: 2

Species	Net	Gross Merch	Gross	# of Trees
Douglas Fir	132.0	149.0	156.0	238
Western Hemlock	1.0	1.0	2.0	9
Totals:	133.0	150.0	158.0	247

Net Volume/Acre: 9.5 MBF

Regeneration Harvest	14.0
Partial Cut	0.0
Right of Way	0.0
Total Acres:	14.0

Unit: 3

Species	Net	Gross Merch	Gross	# of Trees
Douglas Fir	429.0	485.0	507.0	773
Western Hemlock	4.0	5.0	6.0	29
Totals:	433.0	490.0	513.0	802

Net Volume/Acre: 10.1 MBF

Regeneration Harvest	43.0
Partial Cut	0.0
Right of Way	0.0
Total Acres:	43.0

Unit: 4

Species	Net	Gross Merch	Gross	# of Trees
Douglas Fir	132.0	149.0	156.0	238
Western Hemlock	1.0	1.0	2.0	9
Totals:	133.0	150.0	158.0	247

Net Volume/Acre: 10.2 MBF

Regeneration Harvest	13.0
Partial Cut	0.0
Right of Way	0.0
Total Acres:	13.0

Unit: 5

Species	Net	Gross Merch	Gross	# of Trees
Douglas Fir	99.0	112.0	117.0	178
Western Hemlock	1.0	1.0	2.0	7
Totals:	100.0	113.0	119.0	185

Net Volume/Acre: 10.0 MBF

Regeneration Harvest	10.0
Partial Cut	0.0
Right of Way	0.0
Total Acres:	10.0

Unit: 6

Species	Net	Gross Merch	Gross	# of Trees
Douglas Fir	66.0	74.0	78.0	120
Western Hemlock	1.0	1.0	2.0	4
Totals:	67.0	75.0	80.0	124

Net Volume/Acre: 13.4 MBF

Regeneration Harvest	5.0
Partial Cut	0.0
Right of Way	0.0
Total Acres:	5.0

Unit: 7

Species	Net	Gross Merch	Gross	# of Trees
Douglas Fir	66.0	74.0	78.0	120
Western Hemlock	1.0	1.0	2.0	4
Totals:	67.0	75.0	80.0	124

Net Volume/Acre: 11.2 MBF

Regeneration Harvest	6.0
Partial Cut	0.0
Right of Way	0.0
Total Acres:	6.0

Unit: 8

Species	Net	Gross Merch	Gross	# of Trees
Douglas Fir	33.0	37.0	39.0	59
Western Hemlock	1.0	1.0	2.0	4
Totals:	34.0	38.0	41.0	63

Net Volume/Acre: 11.3 MBF

Regeneration Harvest	3.0
Partial Cut	0.0
Right of Way	0.0
Total Acres:	3.0

Unit: 9

Species	Net	Gross Merch	Gross	# of Trees
Douglas Fir	33.0	37.0	39.0	59
Western Hemlock	1.0	1.0	2.0	4
Totals:	34.0	38.0	41.0	63

Net Volume/Acre: 11.3 MBF

Regeneration Harvest	3.0
Partial Cut	0.0
Right of Way	0.0
Total Acres:	3.0

Total Stump To Truck	Net Volume	\$/MBF
\$876,239.32	3,340.0	\$262.35

Stump to Truck: Falling, Bucking, Yarding, & Loading

Yarding System	Unit of Measure	# of Units of Measure	\$/Unit of Measure	Total Cost	Remarks
Yoder	GM MBF	980.0	\$321.81	\$315,373.80	3 loads per day
Shovel	GM MBF	2,792.0	\$200.31	\$559,265.52	4 loads per day
Subtotal				\$874,639.32	

Additional Costs

Item	Unit of Measure	# of Units of Measure	\$/Unit of Measure	Total Cost	Remarks
Subtotal				\$0.00	

Additional Moves

Equipment	Unit of Measure	# of Units of Measure	\$/Unit of Measure	Total Cost	Remarks
Yoder	Each	1.0	\$800.00	\$800.00	Additional Move In due to Sale being scattered in 2 townships , multiple sections, and hauling equipment along paved road
Shovel	Each	1.0	\$800.00	\$800.00	Additional Move In due to Sale being scattered in 2 townships , multiple sections, and hauling equipment along paved road
Subtotal				\$1,600.00	

Comments:

Fuel at \$5.11 per gallon. 5MBF per load. Used GM volume.

Total	Net Volume	\$/MBF
\$271,584.00	3,340.0	\$81.31

Utilization Center	One Way Mileage	Description	Unit of Measure	# of Units	\$/Unit of Measure	Total Cost	% of Sale Volume
Salem OR	60.0	Saw logs	GM MBF	3,772.0	\$72.00	\$271,584.00	100 %

Comments:

Used medium haul rate of \$72. (\$120/Hour, 51-60 miles @ 3 Hours per load, 5 MBF /Load)

Engineering Allowances

Total	Net Volume	\$/MBF
\$78,432.63	3,340.0	\$23.48

Cost Item	Total Cost
Road Construction:	\$52,150.32
Road Maintenance/Rockwear:	\$26,282.31
Road Use Fees:	\$0.00

Total	Net Volume	\$/MBF
\$63,204.12	3,340.0	\$18.92

Environmental Protection

Cost item	Total Cost
Grass seed	\$600.00
Grass seed spreading	\$560.00
Equipment washing	\$400.00
Subtotal	\$1,560.00

Road Construction, Maintenance, Use, & Decommissioning

Cost item	Total Cost
Purchaser Maint.	\$30,144.12
Subtotal	\$30,144.12

Slash Disposal & Site Prep

Cost item	Total Cost
Machne pile burn	\$7,500.00
Machine pile and cover	\$24,000.00
Subtotal	\$31,500.00